

wardell-armstrong.com

ENERGY AND CLIMATE CHANGE  
ENVIRONMENT AND SUSTAINABILITY  
INFRASTRUCTURE AND UTILITIES  
LAND AND PROPERTY  
MINING AND MINERAL PROCESSING  
MINERAL ESTATES  
WASTE RESOURCE MANAGEMENT



**LUNDIN MINING CORPORATION**

**NI 43-101 TECHNICAL REPORT ON THE NEVES-CORVO MINE, PORTUGAL**

**February 22, 2023**



**DATE ISSUED:** February 22, 2023  
**JOB NUMBER:** ZT61-2110  
**REPORT NUMBER:** MM1617  
**STATUS:** Final

**NI 43-101 TECHNICAL REPORT ON THE NEVES-CORVO MINE, PORTUGAL**

**Effective Date: December 31, 2022**

**Signature Date: February 22, 2023**

**AUTHORED BY:**

Richard Ellis	Principal Resource Geologist	["signed and sealed"]
Philip King	Technical Director (Mineral Processing)	["signed and sealed"]
Stuart Richardson	Associate Director (Mining Engineering)	["signed and sealed"]
Alison Allen	Regional Director (Environmental and Social)	["signed and sealed"]



Wardell Armstrong is the trading name of Wardell Armstrong International Ltd,  
Registered in England No. 3813172.

Registered office: Sir Henry Doulton House, Forge Lane, Etruria, Stoke-on-Trent, ST1 5BD, United Kingdom

UK Offices: Stoke-on-Trent, Cardiff, Carlisle, Edinburgh, Greater Manchester, London, Newcastle upon Tyne,  
Sheffield, Taunton, Truro, West Bromwich. International Office: Almaty

ENERGY AND CLIMATE CHANGE  
ENVIRONMENT AND SUSTAINABILITY  
INFRASTRUCTURE AND UTILITIES  
LAND AND PROPERTY  
MINING AND MINERAL PROCESSING  
MINERAL ESTATES  
WASTE RESOURCE MANAGEMENT

**CONTENTS**

<b>1</b>	<b>SUMMARY.....</b>	<b>1</b>
1.1	Property Description.....	1
1.2	History.....	2
1.3	Geological Setting, Mineralisation and Deposit Type.....	3
1.4	Exploration.....	4
1.5	Drilling.....	4
1.6	Sample Preparation, Analyses, Security and Data Verification.....	4
1.7	Mineral Processing and Metallurgical Testing.....	5
1.8	Mineral Resource Estimates.....	5
1.9	Mineral Reserve Estimates.....	7
1.10	Mining Methods.....	8
1.11	Recovery Methods.....	9
1.12	Project Infrastructure.....	9
1.13	Market Studies and Contracts.....	10
1.14	Environmental Studies, Permitting and Social or Community Impact.....	10
1.15	Capital and Operating Costs.....	11
1.16	Economic Analysis.....	11
1.17	Conclusions and Recommendations.....	12
<b>2</b>	<b>INTRODUCTION.....</b>	<b>14</b>
2.1	Terms of Reference.....	15
2.2	Qualified Persons.....	15
2.3	Personal Inspections.....	16
2.4	WAI Declaration.....	16
2.5	Units and Currency.....	17
2.6	Forward-Looking Information.....	17
<b>3</b>	<b>RELIANCE ON OTHER EXPERTS.....</b>	<b>19</b>
<b>4</b>	<b>PROPERTY DESCRIPTION AND LOCATION.....</b>	<b>20</b>
4.1	Mineral Tenure.....	21
4.2	Access Rights and Surface Land Ownership.....	25
4.3	Royalties.....	26
4.4	Taxes.....	26
4.5	Environmental Aspects.....	26
4.6	Other Permits.....	26
<b>5</b>	<b>ACCESSIBILITY, CLIMATE, LOCAL RESOURCES, INFRASTRUCTURE AND PHYSIOGRAPHY.....</b>	<b>27</b>
5.1	Accessibility.....	27
5.2	Climate.....	27
5.3	Local Resources.....	27
5.4	Infrastructure.....	27
5.5	Physiography.....	28
<b>6</b>	<b>HISTORY.....</b>	<b>29</b>
6.1	Ownership and Development History.....	29
6.2	Exploration History.....	31

6.1	Production History .....	32
<b>7</b>	<b>GEOLOGICAL SETTING AND MINERALISATION.....</b>	<b>34</b>
7.1	Regional Geology .....	34
7.2	Local and Property Geology .....	38
7.3	Mineralised Zones.....	41
7.4	Corvo.....	43
7.5	Graça.....	44
7.6	Neves.....	45
7.7	Zambujal.....	46
7.8	Lombador .....	47
7.9	Monte Branco .....	49
7.10	Semblana.....	49
<b>8</b>	<b>DEPOSIT TYPES .....</b>	<b>50</b>
<b>9</b>	<b>EXPLORATION.....</b>	<b>53</b>
<b>10</b>	<b>DRILLING .....</b>	<b>58</b>
10.1	Drilling History.....	58
10.2	Diamond Core Drilling.....	61
10.3	Core Diameter .....	61
10.4	Core Recovery .....	61
10.5	Surveying.....	61
10.6	Drilling Extents.....	62
10.7	Adequacy of Procedures .....	63
<b>11</b>	<b>SAMPLE PREPARATION, ANALYSES, AND SECURITY.....</b>	<b>64</b>
11.1	Face Sampling .....	64
11.2	Core Sampling .....	64
11.3	Bulk Density Determination .....	65
11.4	Sample Preparation .....	68
11.5	Sample Analysis.....	69
11.6	Sample Security and Chain of Custody .....	72
11.7	Quality Assurance and Quality Control Programmes .....	72
<b>12</b>	<b>DATA VERIFICATION.....</b>	<b>82</b>
12.1	Data Verification by SOMINCOR .....	82
12.2	Database Cut-Off Dates .....	84
12.3	Data Verification by The Authors.....	84
<b>13</b>	<b>MINERAL PROCESSING AND METALLURGICAL TESTING .....</b>	<b>87</b>
13.1	XPS Copper Variability Testwork (2018) .....	87
13.2	XPS Zinc Geomet Testwork (2018).....	94
13.3	Conclusions .....	102
13.4	WAI Testwork (2019) .....	103
13.5	Conclusions .....	105
13.6	Adequacy of Testwork .....	105
<b>14</b>	<b>MINERAL RESOURCE ESTIMATE .....</b>	<b>106</b>
14.1	Introduction .....	106

14.2	Mineral Resource Estimate Data .....	106
14.3	Geological Interpretation and Domaining .....	109
14.4	Drillhole Data Processing .....	110
14.5	Compositing .....	110
14.6	Grade Capping.....	110
14.7	Metal Correlations .....	111
14.8	Variography.....	113
14.9	Block Modelling.....	114
14.10	Density .....	115
14.11	Grade Estimation .....	115
14.12	Model Validation.....	116
14.13	Mineral Resource Reconciliation .....	116
14.14	Mineral Resource Depletion and Non-Recoverable Mineral Resources .....	121
14.15	Cut-Off Grades for Mineral Resource Evaluation .....	121
14.16	Mineral Resource Classification.....	121
14.17	Mineral Resource Statement .....	124
<b>15</b>	<b>MINERAL RESERVE ESTIMATES .....</b>	<b>126</b>
15.1	Mining Cut-Off .....	126
15.2	Dilution.....	127
15.3	Mining Recovery .....	128
15.4	Design Process .....	128
15.5	Mineral Reserve Statement .....	129
<b>16</b>	<b>MINING METHODS.....</b>	<b>131</b>
16.1	Overview of Mining Operations.....	131
16.2	Stoping Methods.....	135
16.3	Life of Mine Schedule.....	141
16.4	Geotechnics & Rock Mechanics .....	142
16.5	Water Resources and Hydrogeology .....	149
16.6	Underground Grade Control Sampling .....	151
16.7	Mobile Mining Equipment Fleet .....	151
16.8	Projects .....	152
16.9	Backfill Plants .....	154
16.10	Ventilation.....	155
16.11	Mine Services .....	157
<b>17</b>	<b>RECOVERY METHODS.....</b>	<b>159</b>
17.1	Copper Ore Processing.....	159
17.2	Zinc Ore Processing .....	165
17.3	Mill Labour .....	172
17.4	Analytical Laboratory .....	174
17.5	Adequacy of Supply of Energy, Water and Process Materials.....	174
<b>18</b>	<b>PROJECT INFRASTRUCTURE .....</b>	<b>175</b>
18.1	Power .....	178
18.2	Water .....	179

18.3	Tailings Storage Facility (TSF) .....	180
18.4	Infrastructure for Transportation of Concentrates.....	181
<b>19</b>	<b>MARKET STUDIES AND CONTRACTS.....</b>	<b>184</b>
<b>20</b>	<b>ENVIRONMENTAL STUDIES, PERMITTING AND SOCIAL OR COMMUNITY IMPACT.....</b>	<b>185</b>
20.1	Project Status, Activities, Effects, Releases and Controls .....	185
20.2	Environmental and Social Impact .....	192
20.3	Environmental Management .....	192
20.4	Emergency Preparedness and Response .....	194
20.5	Training .....	194
20.6	Social and Community Management.....	195
20.7	Health and Safety.....	196
20.8	Mine Closure Plan .....	198
<b>21</b>	<b>CAPITAL AND OPERATING COSTS.....</b>	<b>199</b>
21.1	Capital Costs.....	199
21.2	Operating Costs.....	199
<b>22</b>	<b>ECONOMIC ANALYSIS.....</b>	<b>201</b>
<b>23</b>	<b>ADJACENT PROPERTIES .....</b>	<b>202</b>
<b>24</b>	<b>OTHER RELEVANT DATA AND INFORMATION.....</b>	<b>203</b>
<b>25</b>	<b>INTERPRETATION AND CONCLUSIONS .....</b>	<b>204</b>
25.1	Geology and Mineral Resource Estimates .....	204
25.2	Mining and Mineral Reserve Estimates .....	204
25.3	Mineral Processing.....	205
25.4	Infrastructure .....	206
25.5	Environmental Studies, Permitting and Social or Community Impact.....	206
25.6	Capital and Operating Costs.....	206
25.7	Economic Analysis.....	206
25.8	Risks and Uncertainties.....	206
<b>26</b>	<b>RECOMMENDATIONS.....</b>	<b>207</b>
26.1	Geology and Mineral Resource Estimates .....	207
26.2	Mining Methods & Mineral Reserve Estimate.....	207
26.3	Mineral Processing.....	207
26.4	Environmental Studies, Permitting and Social or Community Impact.....	207
<b>27</b>	<b>REFERENCES .....</b>	<b>209</b>

**TABLES**

Table 1.1:	Audited Mineral Resource Statement for Neves-Corvo Copper Zones .....	6
Table 1.2:	Audited Mineral Resource Statement for Neves-Corvo Zinc Zones .....	6
Table 1.3:	Audited Mineral Resource Statement for Semblana Copper Zones .....	7
Table 1.4:	Audited Mineral Reserve Statement for Neves-Corvo.....	8
Table 2.1:	Qualified Persons Responsibilities .....	16
Table 4.1:	Coordinates of the Neves-Corvo Mining Area (Area A) .....	24
Table 4.2:	Coordinates of the Semblana Mining Area (Area B) .....	24

Table 4.3: Coordinates of the Exploration Concession .....	25
Table 6.1: History of Exploration Drilling .....	32
Table 6.2: Neves-Corvo Mine Copper and Zinc Production .....	33
Table 7.1: Neves-Corvo Mineralisation Types .....	43
Table 9.1: Summary of Exploration Drilling in 2017 - 2021 .....	55
Table 9.2: Summary of Planned Exploration Drilling in 2022 .....	56
Table 10.1: Summary of Surface Drilling at Neves-Corvo Mine .....	59
Table 10.2: Summary of Underground Drilling at Neves-Corvo Mine .....	60
Table 11.1: Logging Codes .....	65
Table 11.2: Regression Formulae for Estimation of Density .....	67
Table 11.3: Summary of CRMs used in Analysis of Semblana Samples .....	79
Table 12.1: Histogram Distributions for Factoring Cu Grades of Stockwork Face Samples .....	82
Table 12.2: Database Cut-Off Dates by Deposit .....	84
Table 13.1: XPS Copper Variability Head Assays .....	87
Table 13.2: Zinc Variability Test Head Grades .....	95
Table 13.3: Bond Ball Mill Work Index Results (kWh/t) .....	95
Table 13.4: Summary of Locked Cycle Test Results .....	104
Table 14.1: Drillhole and Face Sample Data used for Mineral Resource Estimation .....	107
Table 14.2: Neves-Corvo Mineralisation Types .....	109
Table 14.3: Summary of Outlier Values Excluded from 2 <sup>nd</sup> and 3 <sup>rd</sup> Searches of Grade Estimation .....	111
Table 14.4: Correlation Matrix for Metals and Density for Massive Zinc (MZ) Zone at Lombador .....	112
Table 14.5: Correlation Matrix for Metals and Density for Massive Copper (MC) Zone at Lombador .....	112
Table 14.6: Correlation Matrix for Metals and Density for Stockwork Copper (FC) Zone at Lombador .....	112
Table 14.7: Variogram Model for Massive Zinc (MZ) Zone at Lombador .....	113
Table 14.8: Variogram Model for Massive Copper (MC) Zone at Lombador .....	114
Table 14.9: Variogram Model for Stockwork Copper (FC) Zone at Lombador .....	114
Table 14.10: Grade Estimation Parameters .....	116
Table 14.11: Summary of Annual Reconciliation (2021) for Copper Zones .....	117
Table 14.12: Summary Annual Reconciliation (2021) for Zinc Zones .....	119
Table 14.13: Summary of Maximum Search Radii used for Mineral Resources Classification .....	122
Table 14.14: Audited Mineral Resource Statement for Neves-Corvo Copper Zones .....	125
Table 14.15: Audited Mineral Resource Statement for Neves-Corvo Zinc Zones .....	125
Table 14.16: Audited Mineral Resource Statement for Semblana Copper Zones .....	125
Table 15.1: Metal Prices used in Calculation of NSR .....	126
Table 15.2: Cut-Off Values – Cost Element Inputs .....	127
Table 15.3: Dilution Factors .....	128
Table 15.4: Audited Mineral Reserve Statement for Neves-Corvo .....	130
Table 16.1: Neves-Corvo Life of Mine Schedule by Ore Type .....	141
Table 16.2: Distribution of Rock Mass Class for Common Rock Types at Neves-Corvo .....	143
Table 16.3: LP2 Geotechnical Parameters (Mining One Consultants (2021)) .....	144
Table 16.4: Mobile Mine Equipment Fleet Requirement .....	152

Table 16.5: Backfill Specification by Mining Method.....	154
Table 17.1: Copper Plant Consumables (2021).....	164
Table 17.2: Copper Plant Production.....	165
Table 17.3: Zinc Plant Consumables (2021).....	172
Table 17.4: Mill Labour.....	173
Table 17.5: Zinc Plant Production.....	173
Table 18.1: Copper Plant and Zinc Plant Associated Infrastructure.....	178
Table 21.1: Summary of Capital Costs (2023 to 2032).....	199
Table 21.2: Summary of Operating Costs (2023 to 2032).....	199
Table 21.3: Breakdown of Mine and Process Plant Operating Costs (2023 to 2032).....	200

## FIGURES

Figure 4.1: Location of Neves-Corvo Mine.....	20
Figure 4.2: Location of Concessions.....	22
Figure 7.1: Location of Neves-Corvo Mine, Regional Geology and Principal Deposits.....	34
Figure 7.2: Structural Cross Section of the South Portuguese Zone.....	37
Figure 7.3: Geology of the Neves-Corvo Area.....	39
Figure 7.4: Stratigraphic Sequence of Neves-Corvo.....	41
Figure 7.5: Location of Mineralised Zones at Neves-Corvo Mine.....	42
Figure 7.6: Geological Section of Corvo and Graça.....	44
Figure 7.7: Geological Cross-Section of Neves and Lombador.....	46
Figure 7.8: Geological Section of Zambujal.....	47
Figure 7.9: Geological Cross-Section of Neves and Lombador.....	48
Figure 7.10: Geological Section of Zambujal and Semblana.....	49
Figure 8.1: Idealised VMS Deposit.....	50
Figure 9.1: Exploration Areas in the 2017 Five-Year Strategy.....	54
Figure 9.2: Exploration Areas in the 2017 Five-Year Strategy.....	54
Figure 9.3: Exploration Drilling in Lombador North Stockwork.....	56
Figure 9.4: Locations of 2022 Drill Targets.....	57
Figure 10.1: Location of Surface Drillhole Collars.....	62
Figure 10.2: Location of Underground Drillhole Collars.....	63
Figure 11.1: Neves-Corvo Laboratory (XRF) and TecVal (ICP and Volumetric) Analysis for Zn (%).....	70
Figure 11.2: Neves-Corvo Laboratory (XRF) and TecVal (ICP and Electro-Gravimetric) Analysis for Cu (%).....	71
Figure 11.3: Pulp Duplicate Analysis for Zinc.....	73
Figure 11.4: Pulp Duplicate Analysis for Lead.....	74
Figure 11.5: Pulp Duplicate Analysis for Copper.....	74
Figure 11.6: Blank Material Analysis for Zinc.....	75
Figure 11.7: Blank Material Analysis for Lead.....	75
Figure 11.8: Blank Material Analysis for Copper.....	76
Figure 11.9: Analysis of Type 12 Standard Reference Material for Zinc.....	76
Figure 11.10: Analysis of Type 12 Standard Reference Material for Lead.....	77



Figure 11.11: Analysis of Type 11 Standard Reference Material for Copper.....	77
Figure 11.12: Pulp Duplicate Analysis for Copper (ALS vs Neves-Corvo Laboratories) .....	78
Figure 11.13: Blank Sample Analysis (Type10) for Copper, Zinc and Lead (ALS) .....	79
Figure 11.14: Analysis of CRM GBM308-14 for Copper .....	79
Figure 11.15: Analysis of CRM GBM308-12 for Zinc .....	80
Figure 11.16: Analysis of CRM GBM308-14 for Silver .....	80
Figure 11.17: Analysis of CRM GBM308-12 for Lead .....	80
Figure 13.1: Modal mineralogy for the Cu Geomet Composites .....	88
Figure 13.2: Pyrite/Chalcopyrite Composite Ratio vs. Chalcopyrite Liberation.....	89
Figure 13.3 : Chalcopyrite Liberation Data .....	90
Figure 13.4 : Sphalerite Liberation Data .....	90
Figure 13.5 : Galena Liberation Data .....	91
Figure 13.6: Copper Mineral Department .....	92
Figure 13.7: Copper Variability Samples Grade vs. Recovery .....	93
Figure 13.8: Modal Mineralogy for the Zn Variability Composites.....	96
Figure 13.9: Head Grade vs. Measured Average Mineral Grain Size .....	97
Figure 13.10 : Zn Geomet Composite Liberation Data – Chalcopyrite .....	98
Figure 13.11 : Zn Geomet Composite Liberation Data - Sphalerite.....	98
Figure 13.12 : Zn Geomet Composite Liberation Data - Galena .....	99
Figure 13.13: Mass % Mineral >70% Liberated for all Composites.....	100
Figure 13.14 : Zn Geomet Flotation Grade vs. Recovery Curve – Zinc.....	101
Figure 13.15 : Zn Geomet Flotation Grade vs. Recovery Curve - Copper .....	101
Figure 13.16 : Zn Geomet Flotation Grade vs. Recovery Curve - Lead .....	102
Figure 14.1: Location of a) Underground Drillholes b) Surface Drillholes and c) Face Samples at Neves-Corvo.....	108
Figure 14.2: Copper Zones - Reconciliation of Tonnes (2021) .....	117
Figure 14.3: Copper Zones – Reconciliation of Cu Grade (2021).....	118
Figure 14.4: Copper Zones – Reconciliation of Contained Cu Metal (2021).....	118
Figure 14.5: Zinc Zones - Reconciliation of Tonnes (2021) .....	119
Figure 14.6: Zinc Zones – Reconciliation of Zn Grade (2021) .....	120
Figure 14.7: Zinc Zones – Reconciliation of Contained Zn Metal (2021) .....	120
Figure 14.8: Isometric View of Copper Zones Showing Mineral Resource Classification (Measured Resources in Blue, Indicated Resources in Green and Inferred Resources in Red) .....	123
Figure 14.9: Isometric View of Zinc Zones Showing Mineral Resource Classification (Measured Resources in Blue, Indicated Resources in Green and Inferred Resources in Red) .....	124
Figure 16.1: Ore Handling System Schematic.....	133
Figure 16.2: Plan View Showing Neves-Corvo Orebodies.....	134
Figure 16.3: Vertical Section Showing Neves-Corvo Orebodies .....	134
Figure 16.4: Typical Drift-and-Fill Mining Layouts used at Neves-Corvo .....	135
Figure 16.5: Bench-and-Fill Mining Method (Schematic) .....	136
Figure 16.6: Mini Bench-and-Fill Mining Method (Schematic).....	138
Figure 16.7: Optimized Bench-and-Fill Mining Method (Schematic).....	139
Figure 16.8: UHF Mining Method (Schematic) .....	140

Figure 16.9: Sill Recovery Mining Method (Schematic) .....	140
Figure 16.10: Copper Ore Feed Schedule .....	142
Figure 16.11: Zinc Ore Feed Schedule.....	142
Figure 16.12 Lombador Phase 1 Joint Sets .....	145
Figure 16.13 Lombador Phase 2 Joint Sets .....	145
Figure 16.14: Mine Water Management System.....	150
Figure 16.15: Face Sampling Schematic.....	151
Figure 16.16: Mine Ventilation System.....	156
Figure 17.1: Copper Plant Flowsheet.....	160
Figure 17.2: Plan of the ZEP Zinc Plant Expansion .....	166
Figure 17.3: Zinc Plant Flowsheet (“50% Pb”) .....	167
Figure 17.4: Zinc Plant 100% Pb Flowsheet .....	170
Figure 18.1: Neves-Corvo Mine Infrastructure .....	176
Figure 18.2: Neves-Corvo Mine Infrastructure (Inset of Figure 18.1).....	177
Figure 18.3: Cerro do Lobo TSF Key Design Aspects.....	181

## 1 SUMMARY

Lundin Mining Corporation (LMC) is a metal mining company that primarily produces copper, nickel, zinc and gold with projects and operations in Portugal (Neves-Corvo Mine), Chile (Candelaria Mining Complex), United States of America (Eagle Mine), Sweden (Zinkgruvan Mine), Brazil (Chapada Mine) and Argentina (Josemaria Project). LMC is a Canadian public company and its common shares are listed on the Toronto Stock Exchange (LUN) and the NASDAQ Stockholm (LUMI).

LMC commissioned Wardell Armstrong International Limited (WAI) to prepare this Technical Report in accordance with the disclosure requirements of National Instrument 43-101 *Standards of Disclosure for Mineral Projects* (NI 43-101) to disclose recent information about LMC's wholly-owned Neves-Corvo mine in Portugal (Neves-Corvo Mine or Neves-Corvo). This Technical Report includes updated Mineral Resource and Mineral Reserve estimates.

The Neves-Corvo Mine is an underground polymetallic mine located in the western part of the Iberian Pyrite Belt (IPB) and is operated by SOMINCOR - Sociedade Mineira de Neves-Corvo, S.A. (SOMINCOR), a wholly owned subsidiary of LMC. The deposit type is a volcanogenic massive sulphide (VMS) which occurs as lenses of polymetallic (Cu, Zn, Sn, Pb) massive sulphides and stockworks. Seven deposits are present and include: Neves, Corvo, Graça, Zambujal, Lombador, Monte Branco and Semblana. Mine production to date has come from Neves, Corvo, Graça, Zambujal and Lombador. No production has come from Monte Branco or Semblana.

The Neves-Corvo Mine has been in production since 1989. The access for materials and people to the mine is via a ramp from surface while ore hoisting is via a 5m diameter shaft. Mining methods include drift and fill (D&F) and bench and fill (B&F); with the fill comprising mainly paste backfill. The Mine processes copper and zinc rich ores in the copper processing plant (Copper Plant) and zinc processing plant (Zinc Plant) located on the surface. The processing plants use crushing, grinding and flotation methods to produce copper, zinc and lead concentrates. The Copper Plant has a throughput capacity of 2.8Mtpa. In Q1 2022, the Zinc Expansion Project (ZEP) was substantially completed and expanded the capacity of the Zinc Plant from 1.15Mtpa to 2.5Mtpa. Commissioning of the material handling system and processing plant upgrade occurred in Q1 2022. Following ramp-up, full production of zinc concentrates from the ZEP is planned for Q1 2024.

Copper and zinc concentrates are transported by rail to the port of Setúbal and are sold under long term contracts directly to European smelters. The lead concentrates are transported by truck to intermodal terminals at Sines, Setúbal or Lisbon. Contracts for lead concentrate are negotiated on an annual basis for 100% of the annual production.

### 1.1 Property Description

The Neves-Corvo Mine is located in the Alentejo province of southern Portugal, some 15km southeast of the town of Castro Verde. The cities of Faro and Lisbon are located approximately 80km to the south and 200km to the northwest, respectively. The Mine is connected to the national road network and has a dedicated railhead to the Portuguese rail network and the port of Setúbal where the Mine has a

private harbour facility for concentrate shipments. The Mine is connected to the national grid by a single 150kV, 50MVA rated, overhead power line that is 22.5km long. The operation has an efficient water management system which maximises recycling of water and transfer between the mining and mineral processing operations and the Cerro do Lobo Tailings Storage Facility (TSF). Where necessary, fresh water is supplied to the mine via a 400mm diameter pipeline from the Santa Clara reservoir, approximately 40km west of the mine.

The climate of the region is Mediterranean with an average annual temperature of 17°C. There are no major centres of population close to the mine, although several small villages with populations of up to 100 people are found within the Neves-Corvo mining concession. The nearest larger towns are Castro Verde and Almodôvar (both with populations of around 7,000) located 18km to the northwest and 11km to the southwest, respectively. The topography around the mine is relatively subdued, comprising low hills with minimal rock outcrop. Vegetation includes scrubland and holm oak with some areas used for low intensity agriculture.

The Neves-Corvo Mine comprises a mining concession and an exploration concession. The Neves-Corvo Mining Concession Agreement between the Portuguese State and SOMINCOR was signed on November 24, 1994 and covers an area of 28.9km<sup>2</sup>. The mining concession comprises an integrated area including Neves-Corvo (Area A) that covers an area of 13.5km<sup>2</sup> and Semblana (Area B) that covers an area of 15.4km<sup>2</sup> with the rights to exploit the deposits for copper, zinc, lead, silver, gold, tin and cobalt for an initial period of fifty years (until November 23, 2044) with the option to obtain two further extensions of twenty years each. An Exploration Concession surrounds the integrated Neves-Corvo Mining Concession. The Exploration Concession covers an area of 105km<sup>2</sup>, excluding the integrated Mining Concession and is valid until June 28, 2023.

SOMINCOR must pay either a profit-related royalty of 10% or a revenue-based royalty of 1.0% (at the Portuguese State's discretion) on Area A, as well as a 4% revenue-based royalty for copper and associated payable metals and a 3.5% revenue-based royalty for zinc and associated payable metals on Area B.

Other than as disclosed above, the qualified persons are not aware of any significant factors or risks that might affect access or title, or the right or ability to perform work on, the Neves-Corvo Mine.

## **1.2 History**

Mineralisation at Neves-Corvo was discovered in 1977 following an exploration joint venture between Sociedade Mineira de Santiago which has since been transformed into the public limited company owned by the Portuguese government, Empresa de Desenvolvimento Mineiro, S.A. (EDM), Societe d'Etudes de Recherches et d'Exploitations Minières (SEREM) and Société Minière et Metallurgique de Peñarroya, S.A. (SMMP). Following discovery, SOMINCOR was formed to exploit the deposits. The shareholders were EDM 51%, SMMP 24.5% and Coframines 24.5%.

Rio Tinto became involved in the project in 1985 effectively forming a 49:51% joint venture with EDM. This change in shareholding led to a reappraisal of the project with eventual first production commencing from the Upper Corvo and Graça orebodies on January 1, 1989, achieving 1.0Mt of throughput in that year. During development of the mine, significant tonnages of high-grade tin ores were discovered, associated with the copper mineralisation, which led to the rapid construction of a tin processing plant (Tin Plant) that was commissioned in 1990. The railway link through to Setúbal was constructed between 1990-1992 to allow shipment of concentrates and the back-haul of sand for fill.

On June 18, 2004, EuroZinc Mining Corporation (EuroZinc) acquired a 100% interest in SOMINCOR. In 2006, zinc production commenced at Neves-Corvo with processing through the modified Tin Plant.

On October 31, 2006, EuroZinc was acquired by LMC, and subsequently amalgamated with LMC effective November 30, 2006. In June 2007, Silverstone Resources Corporation (subsequently acquired by Wheaton Precious Metals Corp.) agreed to acquire 100% of the life of mine (LOM) payable silver production from Neves-Corvo (Area A). The mine is expected to produce between 0.7 and 1.2 Moz of payable silver annually in the copper concentrate. In September 2009, the decision was made to expand the Zinc Plant to a nominal design capacity of 1.0 Mtpa of zinc ore. The plant was commissioned in the second half of 2011. Lead concentrate production commenced in 2013 when improvements in lead processing were implemented enabling a saleable lead concentrate to be produced. In 2015, and amended in 2017, a Feasibility Study on the ZEP was completed by LMC to expand zinc mining and processing capacity from 1.1 to 2.5Mtpa. ZEP infrastructure was substantially completed by Q1 2022 by the commissioning of the underground material handling system and processing plant upgrade. Following ramp-up, full production of zinc concentrates from the ZEP is planned for Q1 2024.

### **1.3 Geological Setting, Mineralisation and Deposit Type**

The deposits of the Neves-Corvo Mine are located in the western part of the Iberian Pyrite Belt (IPB). The stratigraphy is affected by a complex structural setting resulting from the Variscan orogeny. The whole geological assemblage has been folded into a gentle anticline, termed the Roário-Neves-Corvo anticline. Neves-Corvo is located at the southeastern termination of this anticline and the deposits are distributed on both limbs of the fold. All stratigraphic units have been affected by folding and low angle thrusting. Of these, the Neves-Corvo Main Thrust is the most significant. All geological units and Variscan structures, including thrusts, are also affected by near-vertical faulting.

Seven massive sulphide deposits are present and include: Neves, Corvo, Graça, Zambujal, Lombador, Monte Branco and Semblana. The deposits lie on both flanks of the Roário-Neves-Corvo anticline. Neves, Corvo, Graça, Zambujal and Lombador sulphide lenses are conformable with the stratigraphy and are connected by stockwork 'bridge zones' mostly over the crest of the fold. This has resulted in an almost continuous complex volume of mineralised rock. Monte Branco and Semblana are more peripheral, and no significant continuous mineralised 'bridge' exists to these. The deposits are located at depths of 230m to 1,400m below surface and occur as concentrations of high-grade copper and/or

zinc mineralisation in massive sulphide pyritic lenses, and copper mineralisation within stockwork zones that typically underlie the massive sulphides.

The deposits are classified as VMS deposits that formed in submarine volcanic environments, and are classified according to base metal content, gold content or host-rock lithology.

#### **1.4 Exploration**

Near mine exploration is used to define and expand the existing Mineral Resources while regional exploration surrounding the Neves-Corvo Mine has focused on the search for further blind-type massive sulphide deposits and extensions of existing deposits. The discoveries of Semblana and Monte Branco, in 2010 and 2011, respectively, provided clear evidence that the immediate area surrounding Neves-Corvo remains underexplored and highlighted the importance of integrating multiple exploration techniques such as: airborne magnetics, residual ground gravity, airborne gravity, ground and downhole electromagnetic (EM), and 3D seismic to guide exploration drilling, in combination with a high level of understanding of the structural geology.

In 2017, a mineral inventory range analysis (MIRA) study was undertaken by LMC (and was updated in 2020). The aim of the MIRA was to provide a framework to identify and prioritize exploration targets. Based on this, a significant increase in near mine and regional exploration was initiated by LMC as part of a five-year strategy (2017 to 2021). A total of US\$21.71M was spent on regional exploration drilling during this time and highlighted Zambujal/Semblana Gap Zone, Semblana East and Lombador North Stockwork as further targets. In 2022, a further five-year strategy for exploration (2022 - 2026) was undertaken and in 2022 a total of US\$7.14M was spent for further regional exploration drilling.

#### **1.5 Drilling**

Drilling is undertaken by contractors using diamond core drilling from surface and underground. Underground drilling is a continuous activity for exploration, upgrading of Mineral Resources, and defining mineralised contacts ahead of production. Surface drilling campaigns have been important over the years in stepping out beyond the limits of underground development to explore extensions to mineralisation and for regional exploration. A total of 811,776m of surface drilling and 892,522m of underground drilling were completed at the Neves-Corvo Mine as of June 30, 2022. The drilling and core sample collection is undertaken by competent personnel using procedures that are consistent with industry best practices.

#### **1.6 Sample Preparation, Analyses, Security and Data Verification**

Face samples are collected from underground production faces (5m x 5m in dimension) and are sampled by chip sampling every second or third advance (i.e sampled every 6m to 9m) using vertical channel chip sampling in both the massive and stockwork mineralisation. A 3 x 3 grid of vertical

channel samples, each of 1m in length are collected and are dispatched to the sample preparation facility at the on-site facility at Neves-Corvo Mine.

Logging and sampling of the drill core is undertaken at the on-site facility at Neves-Corvo or the exploration facility at Lombador. Sample cutting is undertaken at Lombador and sample preparation and analysis is undertaken at the Neves-Corvo analytical laboratory which is ISO 17025 accredited. Sample preparation of drill core from the Semblana exploration drilling in 2010 to 2013 was undertaken at ALS laboratories, Seville with assaying by ALS, Vancouver. Density measurements are undertaken at the Lombador exploration facility.

A systematic Quality Assurance / Quality Control (QA/QC) system is used to monitor the accuracy and precision of assaying. The sample preparation, security, analyses and data verification procedures for samples sent to both the Neves-Corvo and ALS laboratories have been conducted in accordance with acceptable industry standards and the assay results generated following these procedures are suitable for use in Mineral Resource estimation.

### **1.7 Mineral Processing and Metallurgical Testing**

Metallurgical testing of future ore sources was undertaken in 2018 and 2019 at XPS (Canada) and WAI (UK) laboratories, respectively. Expert Process Solutions (XPS) undertook geometallurgical variability testing on seven samples of copper ore and seven samples of zinc ore. The results demonstrated the relationship between mineralogy and process recoveries and were consistent with those obtained from previous testing. The testwork by WAI was undertaken on two primary composite samples and four secondary composite samples which reflect the ore reserves for the Neves-Corvo Mine and confirmed the differences between the copper recoveries that will be achieved with the massive and stockwork ore types.

The metallurgical sample selection for the testwork programmes was undertaken by competent personnel following a detailed geometallurgical review of the various mineralization using procedures that are consistent with industry best practices. The mineralization tested were representative of future ore sources and the testing was contracted to competent and experienced laboratories. The testwork indicated that levels of impurities in the concentrates were similar to those achieved historically by the operation.

### **1.8 Mineral Resource Estimates**

Mineral Resource estimates were prepared using drilling, face sampling and geological mapping data to construct three dimensional wireframes of mineralised domains. Grades were estimated into a geological block model representing each mineralised domain. Grade estimation was carried out by ordinary kriging or inverse distance weighting. Estimated grades were validated globally, locally, and visually prior to tabulation of the Mineral Resources. Reconciliation indicates that the Mineral Resource models compare satisfactorily to plant production data.

The Mineral Resource estimates for the Neves-Corvo deposits (Neves, Corvo, Graça, Zambujal, Lombador and Monte Branco) and the Semblana deposit are classified in accordance with the Canadian Institute of Mining, Metallurgy and Petroleum (CIM) Definition Standards for Mineral Resources and Mineral Reserves (2014). A summary of the Mineral Resource estimates is shown in Table 1.1, Table 1.2 and Table 1.3. The effective date of the Mineral Resource estimates is December 31, 2022.

The stated Mineral Resources are not materially affected by any known environmental, permitting, legal, title, taxation, socio-economic, marketing, political or other relevant issues, to the best knowledge of the authors. There are no known mining, metallurgical, infrastructure, or other factors that materially affect this Mineral Resource estimate, at this time.

<b>Table 1.1: Audited Mineral Resource Statement for Neves-Corvo Copper Zones Wardell Armstrong International (WAI), effective December 31, 2022</b>									
Resource Classification	Tonnage (kt)	Grade				Metal			
		Cu (%)	Zn (%)	Pb (%)	Ag (g/t)	Cu (kt)	Zn (kt)	Pb (kt)	Ag (Koz)
Measured	8,222	3.5	0.8	0.3	43	288	66	24	11,440
Indicated	47,811	2.0	0.8	0.3	44	971	386	165	67,383
<b>Measured + Indicated</b>	<b>56,033</b>	<b>2.2</b>	<b>0.8</b>	<b>0.3</b>	<b>44</b>	<b>1,259</b>	<b>452</b>	<b>189</b>	<b>78,824</b>
Inferred	14,185	1.8	0.6	0.2	29	255	90	34	13,259

Notes:  
 1. Mineral Resources are reported at a cut-off grade of 1.0% Cu  
 2. Mineral Resources are not reserves until they have demonstrated economic viability based on a feasibility study or pre-feasibility study;  
 3. Mineral Resources are reported inclusive of any Mineral Reserves;  
 4. Grade represents estimated contained metal in the ground and has not been adjusted for metallurgical recovery; and  
 5. Numbers may not add due to rounding.

<b>Table 1.2: Audited Mineral Resource Statement for Neves-Corvo Zinc Zones Wardell Armstrong International (WAI), effective December 31, 2022</b>									
Resource Classification	Tonnage (kt)	Grade				Metal			
		Cu (%)	Zn (%)	Pb (%)	Ag (g/t)	Cu (kt)	Zn (kt)	Pb (kt)	Ag (Koz)
Measured	9,615	0.3	7.7	1.7	66	32	745	165	20,412
Indicated	55,486	0.3	6.7	1.4	60	186	3,693	751	106,895
<b>Measured + Indicated</b>	<b>65,101</b>	<b>0.3</b>	<b>6.8</b>	<b>1.4</b>	<b>61</b>	<b>219</b>	<b>4,437</b>	<b>917</b>	<b>127,306</b>
Inferred	3,897	0.3	5.7	1.6	64	13	223	62	8,028

Notes:  
 1. Mineral Resources are reported at a cut-off grade of 4.5% Zn  
 2. Mineral Resources are not reserves until they have demonstrated economic viability based on a feasibility study or pre-feasibility study;  
 3. Mineral Resources are reported inclusive of any Mineral Reserves;  
 4. Grade represents estimated contained metal in the ground and has not been adjusted for metallurgical recovery; and  
 5. Numbers may not add due to rounding.



**Table 1.3: Audited Mineral Resource Statement for Semblana Copper Zones  
 Wardell Armstrong International (WAI), effective December 31, 2022**

Resource Classification	Tonnage (kt)	Grade				Metal			
		Cu (%)	Zn (%)	Pb (%)	Ag (g/t)	Cu (kt)	Zn (kt)	Pb (kt)	Ag (Koz)
Inferred	7,807	2.9	-	-	25	223	-	-	6,299

Notes:  
 1. Mineral Resources are reported at a cut-off grade of 1.0% Cu  
 2. Mineral Resources are not reserves until they have demonstrated economic viability based on a feasibility study or pre-feasibility study;  
 3. Mineral Resources are reported inclusive of any Mineral Reserves;  
 4. Grade represents estimated contained metal in the ground and has not been adjusted for metallurgical recovery; and  
 5. Numbers may not add due to rounding.

## 1.9 Mineral Reserve Estimates

The Mineral Reserve estimate for Neves-Corvo includes the Neves, Corvo, Graça, Zambujal and Lombador deposits.

The Semblana and Monte Branco deposits currently comprise only *Inferred* Mineral Resources and as such are not considered within the Mineral Reserve estimate.

Due to the polymetallic nature of orebodies, a Net Smelter Return (NSR) calculation is used to determine the value of each individual stope or stope block. The Mineral Reserves are then calculated based on a recovered payable basis considering copper, lead, zinc and silver grades, metallurgical recoveries, prices and realisation costs. Average cut-off values (COVs) range from €44-60/t depending upon ore type, orebody and mining method. Mining dilution is applied to excavations on the basis of development profile and stope dimensions. Total stope dilution includes a range of diluting sources including backfill, Inferred material and material below COV.

Mine design and scheduling works follow a defined process which conforms to industry best practice for the estimation of Mineral Reserves. Stope locations are identified using a mineable stope optimiser (MSO), with final stope designs augmented by manual checks and verifications. Development headings are designed manually according to mining method and location. All stope areas are designed based upon average block NSR values, with NSR calculations provided by LMC's corporate department and incorporated into the Mineral Resource block models prior to commencement of the mine design stage. The optimised life of mine schedule was prepared by applying maximum stope, panel and level production rates to the designed stopes and development headings.

The Mineral Reserve estimate for Neves-Corvo is classified in accordance with the CIM Definition Standards for Mineral Resources and Mineral Reserves (2014). Mineral Reserves are derived from Measured or Indicated Mineral Resources after applying economic parameters to calculate that portion of the Measured and Indicated Mineral Resources that can be mined economically. Mineral Reserves are classified using the following criteria:

- Proven Mineral Reserves are the Measured Mineral Resources where development work for mining and information on processing/metallurgy and other relevant factors demonstrate that economic extraction is achievable.

- Probable Mineral Reserves are those Measured and Indicated Mineral Resources where development work for mining and information on processing/metallurgy and other relevant factors demonstrate that economic extraction is achievable.

The audited Mineral Reserve statement for Neves-Corvo is shown in Table 1.4. The effective date of the Mineral Reserve estimate is December 31, 2022.

The stated Mineral Reserves are not materially affected by any known environmental, permitting, legal, title, taxation, socio-economic, marketing, political or other relevant issues, to the best knowledge of the authors. There are no known mining, metallurgical, infrastructure, or other factors that materially affect this Mineral Reserve estimate, at this time.

<b>Table 1.4: Audited Mineral Reserve Statement for Neves-Corvo Wardell Armstrong International (WAI), effective December 31, 2022</b>									
<b>Copper Zones</b>									
<b>Reserve Classification</b>	<b>Tonnage (kt)</b>	<b>Grade</b>				<b>Contained Metal</b>			
		<b>Cu (%)</b>	<b>Zn (%)</b>	<b>Pb (%)</b>	<b>Ag (g/t)</b>	<b>Cu (kt)</b>	<b>Zn (kt)</b>	<b>Pb (kt)</b>	<b>Ag (Koz)</b>
Proven	3,095	3.2	0.6	0.2	33	99	19	5	3,254
Probable	18,112	1.9	0.6	0.2	33	339	117	42	19,390
<b>Proven + Probable</b>	<b>21,207</b>	<b>2.1</b>	<b>0.6</b>	<b>0.2</b>	<b>33</b>	<b>438</b>	<b>135</b>	<b>47</b>	<b>22,644</b>
<b>Zinc Zones</b>									
<b>Reserve Classification</b>	<b>Tonnage (kt)</b>	<b>Grade</b>				<b>Contained Metal</b>			
		<b>Cu (%)</b>	<b>Zn (%)</b>	<b>Pb (%)</b>	<b>Ag (g/t)</b>	<b>Cu (kt)</b>	<b>Zn (kt)</b>	<b>Pb (kt)</b>	<b>Ag (Koz)</b>
Proven	3,369	0.3	8.1	2.1	69	11	274	72	7,518
Probable	18,930	0.3	7.4	1.6	62	62	1,393	311	37,603
<b>Proven + Probable</b>	<b>22,299</b>	<b>0.3</b>	<b>7.5</b>	<b>1.7</b>	<b>63</b>	<b>73</b>	<b>1,667</b>	<b>383</b>	<b>45,121</b>
Notes:									
1. Mineral Reserves are reported using a cut-off based on a NSR breakeven price which averages from €44-60/t depending on mining areas and stoping methods;									
2. Metal prices used in the NSR evaluation are US\$3.35/lb for copper, US\$1.15/lb for zinc, US\$0.90/lb for lead. A silver price of US\$4.40/oz is used in the calculation of NSR to reflect the contract to Wheaton Precious Metals Corp;									
3. Mining, processing and administrative costs were estimated based on actual costs; and									
4. Numbers may not add due to rounding.									

## 1.10 Mining Methods

Underground mining at the Neves-Corvo Mine has been continuous since 1988, with the production plan for 2023 budgeted at 2.7Mt of copper ore with an average grade of 1.8% Cu and 2.2Mt of zinc ore with an average grade of 7.2% Zn. From 2024, zinc production is projected to increase to 2.5Mtpa. The final year of full production is 2029. Total hoisted rock (ore and waste) ranges from 5.4Mtpa to 5.8Mtpa.

Mining methods include: Drift & Fill, Bench & Fill, Optimised Bench & Fill, Mini Bench & Fill, Uphole Bench & Fill and Sill Pillar Recovery. The mining methods are well understood and have been developed and upgraded as understanding of the orebodies has increased with time.

An expansion of the shaft capacity to 5.6Mtpa is now largely complete, with the shaft currently operating at some 5.2Mtpa to 5.4Mtpa. Additional measures required to achieve the nameplate capacity of 5.6Mtpa are being implemented. In addition, an extended upgrade to the capacity of the shaft to 6Mtpa is also planned to be completed by 2024 to achieve the LOM plan. Further optimisation of the mining infrastructure at LP2 is also planned for the 260 Level crusher hopper, conveyor transfer towers and conveyors.

### **1.11 Recovery Methods**

The mineral processing plants consist of a Copper Plant and a Zinc Plant which produce copper, zinc and lead concentrates using crushing (Copper Plant), grinding and flotation. The two plants are well established and the ore types that are treated have been extensively researched and their processing characteristics are well understood. The workforce is experienced and possesses a high degree of operational knowledge.

The Copper Plant has a capacity of 2.8Mtpa of ore through two separate grinding lines with a common flotation circuit. Recoveries have reduced marginally in recent years due to lower copper head grades and higher proportion of MH ore (massive copper ore with elevated levels of penalty elements including As, Sb and Hg) in the plant feed. In 2021, the Copper Plant treated 2,564kt of ore at an average grade of 1.86% Cu and produced 167kt of copper concentrate.

The Zinc Plant was constructed in 2006 with a capacity of 0.5Mtpa and was expanded in 2010 to 1.15Mtpa with a further expansion to 2.5Mtpa in 2018 to 2022, as part of the ZEP. In 2021, the Zinc Plant treated 1,060kt of ore at average grades of 7.78% Zn and 1.80% Pb and produced 134kt of zinc concentrate and 22kt of lead concentrate. Production from the Zinc Plant during 2021 was less than capacity due to ramp up of the ZEP.

The flotation performance of the Zinc Plant has been affected by poor quality process water which has recently deteriorated due to the higher proportion of Zinc ore being treated as the ZEP ramp up continues. As such, SOMINCOR plans to increase the capacity of the Water Treatment Plant to improve metallurgical performance.

### **1.12 Project Infrastructure**

The Neves-Corvo Mine is connected to the national grid by a single 150kV, 50MVA rated, overhead power line that is approximately 22.5km in length.

The operation has an efficient water management system which maximises recycling of water and transfer between the mining and mineral processing operations and TSF. Where necessary, fresh water is supplied to the mine via a 400mm diameter pipeline from the Santa Clara reservoir, approximately 40km west of the mine. Process water is stored on the TSF. In addition, the mine has a water storage dam (Cerro da Mina) with a capacity of 1.4Mm<sup>3</sup>.

In 2022, the southern expansion of the footprint of the Cerro do Lobo TSF was commenced to accommodate the ZEP. The TSF storage capacity was expanded from 33.3Mm<sup>3</sup> to 50Mm<sup>3</sup> for extractive waste storage (tailings and waste rock). The expansion will involve a 18.5Ha footprint extension to the south and a vertical expansion from 266.3m in Tier 5 to 283.5m in Tier 13. The TSF design has fill approvals to accommodate the current approved LOM.

All infrastructure required by the operation is in place and no significant additional infrastructure is planned.

### **1.13 Market Studies and Contracts**

Copper and zinc concentrates are sold under long term contracts directly to European smelters. The commercial terms under the contracts are negotiated on an annual basis based on the prevailing market conditions.

Lead concentrate of commercial quality has been produced at the Neves-Corvo Mine since 2012. Contracts have been negotiated on an annual basis for 100% of the annual production.

All silver contained in the concentrates from Area A belongs to Wheaton Precious Metals Corp. under a silver streaming agreement signed with Silverstone Resources (since acquired by Wheaton Precious Metals Corp.) in 2007 and is invoiced separately when the silver content reaches payable levels.

### **1.14 Environmental Studies, Permitting and Social or Community Impact**

In February 2022, the Direção-Geral de Energia e Geologia (DGEG) approved the updated plan for expansion of the TSF and SOMINCOR is currently working on the renewal of the Unified Environmental Permit. In April 2022, DGEG approved the Industrial Permit after completion of the ZEP. The Unified Environmental Permit (TUA) was updated in 2021 after the issuance of Decision of Environmental Compliance of the Execution Project 2 (DECAPE 2) and will be updated again prior to the operation of the TSF expansion. In 2021, the abstraction licence for the supply of water from the Santa Clara reservoir was successfully renewed and a new license for discharge of treated industrial wastewater to the Oeiras River was obtained. An updated Mine Closure Plan (MCP) was submitted to DGEG in December 2022. To inform the MCP, soil, groundwater, and bottom sediments studies have been completed alongside with a two-stage closure-related socioeconomic impact study that was undertaken to identify expectations from key stakeholders to inform the social transition planning process.

Environmental aspects of the Neves-Corvo Mine are managed well and held to a high standard. The requirements of LMC's Responsible Mining Management System (RMMS) are followed with close monitoring of environmental impacts relating to air quality, surface and ground water, noise, aquatic ecology, and heavy metal concentrations in birds' blood and feather. Results of air and water quality control demonstrate general compliance with the permitted thresholds. However, noise emissions resulting from the operation of evaporators require additional mitigation measures.

Recorded environmental incidents at the mine site comprise ruptures in the tailings pipeline. Appropriate measures were taken to mitigate any effects associated with the incidents. Subsequent upgrades ensued to protect the environment and included tailings pipeline replacements and improvements to spill containment structures.

Social Performance has been guided by SOMINCOR's Strategic Social Implementation Plan from 2019. One aspect of the social performance management is community investment, which was reported at US\$295k in 2021 (excluding strategic social investment for entrepreneurship in schools). Three social-specific management plans were approved in 2020 and included: Stakeholder Management Plan, Grievance Management Plan and Communications Plan. Engagement activity is updated and tracked on the Simple Stakeholder platform. Grievances are also monitored and reported; approximately 4 to 5 grievances are registered per year, mostly concerning noise, dust and vibration complaints. Currently all grievances are registered as closed. Social Perception of the Neves-Corvo Mine is positive. In 2018 the Social Perception Study found that 85% of the community approved of the operation and 15% were neutral towards it. This positive result was maintained during the 2021 Social Licence to Operate Survey where the Neves-Corvo Mine scored 3.4/5 in the category measuring trust and 3.6/5 in the acceptance of the continued operations of the mine.

As of December 31, 2022, the Neves-Corvo Mine suffered 26 recordable cases, 16 with SOMINCOR employees and 10 with contractors, including 2 fatalities. In conjunction with the LMC Health & Safety Team, SOMINCOR has been participating in the development of a new injury and fatality prevention process called Fatal Risk Management, which will be the focus of the Health and Safety Team for the next one to three years until it is embedded across the business. The Occupational Health and Safety (OHS) department is involved in supply chain management and has guidelines for contractors.

### **1.15 Capital and Operating Costs**

Capital and operating costs are defined in the LOM schedule and are based on the production plan and operational experience. Total capital costs are estimated at €591.7M over the LOM. Closure costs are estimated at €52.0M based on the LOM cash flow model dated November 14, 2022. Total operating costs over the LOM are estimated at €2,762M which equates to €60.6/t of ore milled.

### **1.16 Economic Analysis**

LMC has opted to exclude the information required under Item 22 of Form 43-101F1 for this Technical Report on a property currently in production unless the Technical Report includes a material expansion of current production.

The cash flow model for the LOM was reviewed by the authors and showed the Mineral Reserves to be economic based on the assumptions used and metal prices of: US\$1.15/lb for zinc, US\$0.90/lb for lead, US\$3.35/lb for copper and US\$4.40/oz for silver (the silver price used reflects the streaming agreement with Wheaton Precious Metals Corp.).

## **1.17 Conclusions and Recommendations**

The authors have reviewed the licensing, geology, exploration, Mineral Resource and Mineral Reserve estimation methods, mining, mineral processing, infrastructure requirements, environmental, permitting, social considerations and financial information and consider the Mineral Resources and Mineral Reserves estimates for the Neves-Corvo Mine, with an effective date of December 31, 2022, are reported in accordance with CIM Definition Standards for Mineral Resources and Mineral Reserves (2014).

The authors make the following recommendations:

### **1.17.1 Geology and Mineral Resource Estimates**

- Continue exploration drilling at Lombador North, Zambujal East and Semblana East and North. A total of US\$7.36M is budgeted for exploration drilling in 2023;
- Recommence density measurements for underground drilling;
- Optimise underground development to provide increased drill access for pre-production drilling;
- Consider using strings or wireframe boundaries to define Mineral Resource classification in the block model;
- Consider the use of a NSR cut-off value for reporting Mineral Resources.

### **1.17.2 Mining Methods & Mineral Reserve Estimate**

Complete all remaining optimisation projects for ZEP to achieve its name plate capacity. The costs for this work have been included in the capital cost estimate with €12.2M in 2023 and €9.6M in 2024.

### **1.17.3 Mineral Processing**

- Prepare an up-to-date Process Design Criteria for the ZEP;
- Upgrade the Water Treatment Plant to 1,200m<sup>3</sup>/h at an estimated cost of €8.1M;
- Undertake lead rougher flotation at pH 9 and zinc rougher flotation at pH 10-11, using the improved water quality;
- Switch the method of lead rougher concentrate regrinding from conventional ball milling to either Isamill or Stirred Media Detritors (SMD). This work is underway, with eventual completion within the Full-Lead project scope.

### **1.17.4 Environmental Studies, Permitting and Social or Community Impact**

- Continue proactive management of pipeline integrity from risk identification to mitigation;
- Continue to monitor and review noise levels from evaporators. Investigate further noise abatement measures and closely monitor any grievances related to noise levels;
- Timely update and submission to the authorities of required operational management plans;

- Monitor and review any incidents of non-conformance, including health and safety (H&S) incidents. Determine any causation and implement risk management measures including continuing to advance the implementation of the Fatal Risk Management program;
- Include an evaluation of H&S performance after suppliers and contractors have completed their work, including H&S monitoring as part of the quality control process of contract closure;
- Make sure to communicate the results of the H&S Committee on a bi-weekly, or at least monthly basis with all SOMINCOR employees, suppliers and contractors. Consider inviting contractors and suppliers as observers during the H&S Committee meetings so they are immediately aware of H&S priorities;
- Implement the proposed gender diversity strategy to encourage female workers to work at Neves-Corvo, plan regional events and scholarships encouraging girls and young women from the region to consider studying mining industry-related subjects.

Costs relating to the authors recommendations for environmental, permitting and social or community impact are included as part of on-going operations.

## 2 INTRODUCTION

This Technical Report has been prepared by Wardell Armstrong International Limited (WAI) in accordance with the disclosure requirements of NI 43-101 to disclose recent information about the Neves-Corvo Mine, Portugal. This information includes updated Mineral Resource and Mineral Reserve estimates.

LMC is a metal mining company that primarily produces copper, nickel, zinc and gold with projects and operations in Portugal (Neves-Corvo Mine), Chile (Candelaria Mining Complex), United States of America (Eagle Mine), Sweden (Zinkgruvan Mine), Brazil (Chapada Mine) and Argentina (Josemaria Project). LMC is a Canadian public company and its common shares are listed on the Toronto Stock Exchange (LUN) and the NASDAQ Stockholm (LUMI).

The Neves-Corvo Mine is an underground polymetallic mine located in the western part of the Iberian Pyrite Belt and is operated by SOMINCOR a wholly owned subsidiary of LMC. The deposit type is a VMS which occurs as lenses of polymetallic (Cu, Zn, Sn, Pb) massive sulphides and stockworks. Seven deposits are present and include: Neves, Corvo, Graça, Zambujal, Lombador, Monte Branco and Semblana. Mine production to date has come from Neves, Corvo, Graça, Zambujal and Lombador. No production has come from Monte Branco or Semblana.

The Neves-Corvo Mine has been in production since 1989. The access for materials and people to the mine is via a ramp from surface while ore hoisting is via a 5m diameter shaft. Mining methods include D&F and B&F; with the fill comprising mainly paste backfill. The Mine processes copper and zinc rich ores in the Copper and Zinc Plants located on the surface. The processing plants use crushing, grinding and flotation methods to produce copper, zinc and lead concentrates.

The Copper Plant has a throughput capacity of 2.8Mtpa. In Q1 2022, the ZEP was substantially completed and expanded the capacity of the Zinc Plant from 1.15Mtpa to 2.5Mtpa. The ZEP included:

- An expansion of zinc production from all existing zinc producing areas of the Neves-Corvo Mine;
- A new materials handling system including:
  - A new primary underground crusher station;
  - 2.9km of new ramp conveyor system to connect the deeper Lombador Phase 2 (LP2) area of the mine with the hoisting shaft;
  - Upgrade of hoisting shaft capacity from 4.9Mtpa to 5.6Mtpa;
- Expansion of the Zinc Plant including a new building for grinding (SAG Mill) and flotation; and
- Expansion of associated project infrastructure

Commissioning of the material handling system and processing plant upgrade occurred in Q1 2022. Following ramp-up, full production of zinc concentrates from the ZEP is planned for Q1 2024.



Tailings from the mine are stored as thickened tailings at the Cerro do Lobo TSF located 3km southeast of the mine. Following completion of ramp-up of the ZEP, the annual production of tailings will be approximately 4.7Mtpa with 46% used as mine backfill and 54% stored in the TSF.

Copper and zinc concentrates are transported by rail to the port of Setúbal and are sold under long term contracts directly to European smelters. The lead concentrates are transported by truck to intermodal terminals at Sines, Setúbal or Lisbon. Contracts for lead concentrate are negotiated on an annual basis for 100% of the annual production.

The effective date of the Mineral Resource and Mineral Reserve estimates is December 31, 2022. This report updates the previous Technical Report prepared by WAI, titled “NI 43-101 Technical Report for the Neves-Corvo Mine, Portugal” and dated June 23, 2017 (effective date of June 30, 2016).

The Mineral Resource and Mineral Reserve estimates are reported in accordance with *CIM Definition Standards For Mineral Resource and Mineral Reserves 2014*, as referenced in NI 43-101. This Technical Report has been prepared in accordance with the requirements of Form 43-101F1.

## 2.1 Terms of Reference

The scope of work included a review of the technical information used to derive the Mineral Resources and Mineral Reserves estimates for the Neves-Corvo Mine with an effective date of December 31, 2022, and preparation of a Technical Report in accordance with the requirements of NI 43-101 to support the public disclosure of the Mineral Resources and Mineral Reserves estimates.

## 2.2 Qualified Persons

Qualified Persons (QPs) from WAI who have reviewed the Mineral Resource and Mineral Reserve estimates and supervised the production of this report are as follows:

- Richard Ellis, BSc, MSc, MCSM, FGS, CGeol, EurGeol, Principal Resource Geologist.
- Philip King, BSc, ARSM, CEng, FIMMM, Technical Director (Mineral Processing).
- Stuart Richardson, BEng, MSc, CEng, MIMMM, Associate Director (Mining Engineering).
- Alison Allen, BSc, MSc, CEnv, FIMMM, MIEMA, MIEEM, Regional Director (Environmental and Social).

In addition, Dr. Phil Newall, a QP from WAI, approved the Mineral Resource and Mineral Reserve estimates.

These consultants by virtue of their education, experience, and professional association, are considered to be independent QPs according to the definitions given in NI 43-101 and are members in good standing of appropriate professional institutions. The responsibilities of the QPs in the preparation of this Technical Report are shown in Table 2.1.

**Table 2.1: Qualified Persons Responsibilities**

No.	Report Section	Report Sub-Sections	Qualified Person
1	Summary	1 (Introduction), 1.1, 1.2, 1.3, 1.4, 1.5, 1.6, 1.8, 1.17 (Introduction), 1.17.1	Richard Ellis
		1.7, 1.11, 1.12, 1.13, 1.15 (Processing Capital and Operating Costs), 1.17.3	Philip King
		1.9, 1.10, 1.15 (Mining Capital and Operating Costs), 1.16, 1.17.2, 1.14, 1.15 (Closure Costs), 1.17.4	Stuart Richardson
			Alison Allen
2	Introduction		Richard Ellis
3	Reliance on other Experts		Richard Ellis
4	Property Description and Location		Richard Ellis
5	Accessibility, Climate, Local Resources, Infrastructure and Physiography		Richard Ellis
6	History		Richard Ellis
7	Geological Setting and Mineralisation		Richard Ellis
8	Deposit Type		Richard Ellis
9	Exploration		Richard Ellis
10	Drilling		Richard Ellis
11	Sample Preparation, Analysis and Security		Richard Ellis
12	Data Verification		Richard Ellis
13	Mineral Processing and Metallurgical Testwork		Philip King
14	Mineral Resource Estimates		Richard Ellis
15	Mineral Reserve Estimates		Stuart Richardson
16	Mining Methods		Stuart Richardson
17	Recovery Methods		Philip King
18	Infrastructure		Philip King
19	Market Studies and Contracts		Philip King
20	Environmental Studies, Permitting and Social or Community Impact		Alison Allen
21	Capital and Operating Costs	21.1 (Processing Capital Costs), 21.2 (Processing Operating Costs)	Philip King
		21.1 (Mining Capital Costs), 21.2 (Mining Operating Costs)	Stuart Richardson
		21.1 (Closure Costs)	Alison Allen
22	Economic Analysis		Stuart Richardson
23	Adjacent Properties		Richard Ellis
24	Other Relevant Data and Information		Richard Ellis
25	Interpretation and Conclusions	25 (Introduction), 25.1, 25.8 (Mineral Resources)	Richard Ellis
		25.2, 25.6 (Mining Capital and Operating Costs), 25.7, 25.8 (Mineral Reserves and Projected Production)	Stuart Richardson
		25.3, 25.4, 25.6 (Processing Capital and Operating Costs)	Philip King
		25.5, 25.6 (Closure Costs)	Alison Allen
26	Recommendations	26 (Introduction), 26.1	Richard Ellis
		26.2	Stuart Richardson
		26.3	Philip King
		26.4	Alison Allen
27	References		Richard Ellis

### 2.3 Personal Inspections

A site visit to the Neves-Corvo Mine was undertaken by Richard Ellis, Philip King and Stuart Richardson on November 2 to November 3, 2022.

### 2.4 WAI Declaration

WAI has provided the mineral industry with specialised geological, mining and mineral processing expertise since 1987, initially as an independent company, but from 1999 as part of the Wardell

Armstrong Group (WA). WAI's experience is worldwide and has been developed in the coal and metalliferous mining sector.

WAI's parent company, WA, is a mining engineering/environmental consultancy that services the industrial minerals sector from nine regional offices in the UK and international office in Almaty, Kazakhstan. Total worldwide staff compliment is in excess of 400.

WAI, its directors, employees and associates neither has nor holds:

- Any rights to subscribe for shares in LMC or SOMINCOR either now or in the future;
- Any vested interests in any mining or exploration concessions (licences) held by LMC or SOMINCOR;
- Any rights to subscribe to any interests in any of the licences held by LMC or SOMINCOR either now or in the future;
- Any vested interests in either any licences held by LMC or SOMINCOR or any adjacent licences; or
- Any right to subscribe to any interests or licences adjacent to those held by LMC or SOMINCOR, either now or in the future.

WAI's only financial interest is the right to charge professional fees at normal commercial rates, plus normal overhead costs, for work carried out in connection with the investigations reported here. Payment of professional fees is not dependent either on project success or project financing.

## **2.5 Units and Currency**

All units of measurement used in this report are metric unless otherwise stated. Tonnages are reported as metric tonnes (t), precious metal grades in grams per tonne (g/t) or parts per million (ppm) and base metal grades in percentage (%).

Unless otherwise stated, all references to currency or "USD" are to United States Dollars (US\$).

## **2.6 Forward-Looking Information**

This Technical Report contains "forward-looking information" and "forward-looking statements" within the meaning of applicable Canadian and the United States securities legislation which involve a number of risks and uncertainties. Forward-looking information and forward-looking statements include, but are not limited to, statements with respect to the future prices of copper, zinc, lead and silver, the estimation of mineral resources and reserves, the realization of mineral estimates, the timing and amount of estimated future production, costs of production, capital expenditures, costs (including capital costs, operating costs and other costs) and timing of the LOM, rates of production, annual revenues, requirements for additional capital, government regulation of mining operations, environmental risks, unanticipated reclamation expenses, title disputes or claims and limitations on insurance coverage.

Often, but not always, forward-looking statements can be identified by the use of words such as “plans”, “expects”, or “does not expect”, “is expected”, “budget”, “scheduled”, “estimates”, “forecasts”, “intends”, “anticipates”, or “does not anticipate”, or “believes”, or variations of such words and phrases or state that certain actions, events or results “may”, “could”, “would”, “might” or “will” be taken, occur or be achieved.

Forward-looking statements are based on the opinions, estimates and assumptions of contributors to this Technical Report. Certain key assumptions are discussed in more detail. Forward looking statements involve known and unknown risks, uncertainties and other factors which may cause the actual results, performance or achievements of LMC to be materially different from any other future results, performance or achievements expressed or implied by the forward-looking statements.

Such factors include, among others: the actual results of current development activities; conclusions of economic evaluations; changes in project parameters as plans continue to be refined; future prices of copper, zinc, lead, silver and other metals; possible variations in ore grade or recovery rates; failure of plant, equipment or processes to operate as anticipated; accidents, labour disputes and other risks of the mining industry delays in obtaining governmental approvals or financing or in the completion of development or construction activities; shortages of labour and materials, the impact on the supply chain and other complications associated with pandemics, including the COVID-19 (coronavirus) pandemic; as well as those risk factors discussed or referred to in this report and in LMC’s documents filed from time to time with the securities regulatory authorities in Canada.

There may be other factors than those identified that could cause actual actions, events or results to differ materially from those described in forward-looking statements, there may be other factors that cause actions, events or results not to be anticipated, estimated or intended. There can be no assurance that forward-looking statements will prove to be accurate, as actual results and future events could differ materially from those anticipated in such statements. Accordingly, readers are cautioned not to place undue reliance on forward-looking statements. Unless required by securities laws, the authors undertake no obligation to update the forward-looking statements if circumstances or opinions should change.

### **3 RELIANCE ON OTHER EXPERTS**

The authors have relied on information provided by LMC as of February 8, 2023, regarding the legal status of the rights pertaining to the Neves-Corvo Mine and have not independently verified the legality of surface land ownership, mineral tenure, legal status or ownership of the properties or any agreements that pertain to the licence areas. The extent of this reliance applies solely to the legal status of the rights detailed in Section 4.

The authors did not verify the legality of any underlying agreement(s) that may exist concerning the permits or other agreement(s) between third parties but have relied on information provided by LMC and SOMINCOR as of February 8, 2023, for land title issues.

#### 4 PROPERTY DESCRIPTION AND LOCATION

The Neves-Corvo Mine is located within the western part of the Iberian Pyrite Belt of southern Spain and Portugal. The mine is situated in the Alentejo province of southern Portugal, approximately 15km southeast of the town of Castro Verde. The cities of Faro and Lisbon are located approximately 80km to the south and 200km to the northwest, respectively. The operation includes: the Neves-Corvo underground mine, mineral processing facilities and associated facilities at the mine site; private harbour and loading facility at Setúbal; sand extraction facilities at Alcácer do Sal and a Lisbon office.

The geographic coordinates of the Neves-Corvo Mine are latitude 37°34'25"N and longitude 07°58'20"W (UTM Zone 29S; UTM coordinates 590757E, 4159004N). The location of the Neves-Corvo Mine is shown in Figure 4.1.



Figure 4.1: Location of Neves-Corvo Mine

#### 4.1 Mineral Tenure

The Neves-Corvo Mine comprises the following concessions:

- A Neves-Corvo Mining Concession. The Mining Concession Agreement between the Portuguese State and SOMINCOR was signed on November 24, 1994, based on several mining permits granted in 1981 and 1985, and as of July 1, 2014, covered an integrated area of 28.9km<sup>2</sup>. The Mining Concession provides the rights to exploit the Neves-Corvo (Area A) and Semblana (Area B) deposits for copper, zinc, lead, silver, gold, tin and cobalt for an initial period of fifty years (until November 23, 2044) with the option to obtain two further extensions of twenty years each. The integrated Neves-Corvo Mining Concession comprises the following areas:
  - The Neves-Corvo area (Mining Concession A) covers an area of 13.5km<sup>2</sup>; and
  - The Semblana area (Mining Concession B) that covers an area of 15.4km<sup>2</sup>.
- An Exploration Concession was granted to SOMINCOR on June 28, 2018, that surrounds the combined Neves-Corvo Mining Concession. The initial Exploration Concession covered an area of 141km<sup>2</sup>, including the integrated Mining Concession area. The Exploration Concession was granted for an initial period of three years with an optional extension of two years subject to a 25% reduction of the initial area. The Exploration Concession is currently in its second year of the extension period and following a reduction of 25% of the initial Exploration Concession area, covers an area of 105km<sup>2</sup>, excluding the integrated Mining Concession. The Exploration Concession is valid until June 28, 2023.

The extents of the concessions in the European Terrestrial Reference System, 1989 (PT-TM06/ETRS89) are shown in Figure 4.2.

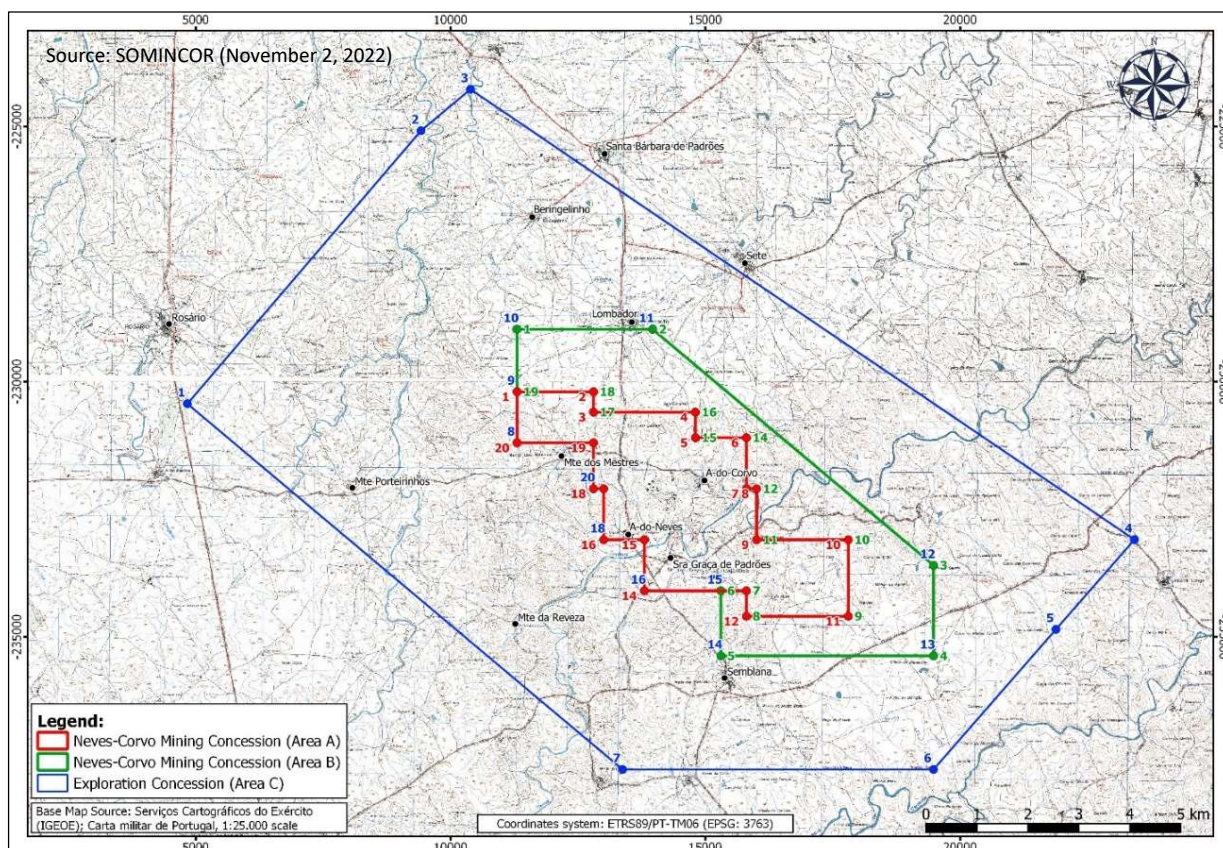

Figure 4.2: Location of Concessions

#### 4.1.1 Mining Concessions

Neves-Corvo mining operations are mandated in the Mining Concession Agreement between the Portuguese State and SOMINCOR. The integrated Neves-Corvo Mining Concessions are located in the parishes of Santa Bárbara de Padrões and Senhora da Graça de Padrões, in the counties of Castro Verde and Almodôvar, of the district of Beja. Under the Mining Concession agreement, SOMINCOR is obliged to:

- Advise the Portuguese government of any changes contemplated in the share ownership of SOMINCOR as the State has certain rights under some change of control circumstances;
- Submit annual operating plans to the State’s technical advisor for approval;
- Undertake the investigations and reconnaissance necessary to complete the evaluation of the Mineral Resources occurring in the concession and to proceed to their exploitation, subject to a technical, economic and financial Feasibility Study;
- Use Portuguese metallurgical refineries/smelters, if such should come into existence in the country and provided they offer competitive international terms;
- Pay either a profit-related royalty of 10% or a revenue-based royalty of 1.0% (at the State’s discretion) on the Neves-Corvo area (Area A). SOMINCOR has paid the 10% profit related royalty for several years; and



- Pay a 4% revenue-based royalty for copper and associated payable metals and a 3.5% revenue-based royalty for zinc and associated payable metals on the Semblana area (Area B).

The royalty payments may be reduced to between 2% to 6% of the profit royalty or of the revenue royalty provided that the corresponding amount of such percentage is spent on (a) mineralogical or metallurgical research projects, (b) projects of a social nature, granting of scholarships, (c) projects of an environmental nature with the purpose to maximize the use and valorisation of mineral contents, the social responsibility and the environmental awareness as well as the industrial mining archaeology, and (d) local projects proposed by municipalities or parishes covered by the concession area, respectively, provided those projects are approved by the Portuguese State. Those deductions are only eligible if they correspond to a maximum of 50%, in case of projects under (a) above, 66% in case of (b) and (c) and 90% in case of (d) of SOMINCOR's contribution for each supported project.

Under a partnership agreement entered into between SOMINCOR and EDM (the Portuguese State mining company) on January 14, 2005, EDM was granted the preferential rights to participate (*partnership right*) in future investments related to exploration of mineral deposits (*mining projects*), located in Portugal, in which SOMINCOR is a party effective at the date of the agreement. On December 31, 2014, EDM formally exercised its definitive option right to invest 15% in the Semblana Project. On December 15, 2021, SOMINCOR completed the buyout of EDM's 15% interest, under an agreement signed by both parties.

#### 4.1.1.1 *Neves-Corvo Mining Area*

The Neves-Corvo Mining Area (Area A) covers 13.5km<sup>2</sup>. A summary of the concession coordinates in the European Terrestrial Reference System (1989) (PT-TM06/ETRS89) is shown in Table 4.1.

Coordinate Point	Easting (m) (ETRS89)	Northing (m) (ETRS89)
1	11,304.078	-230,198.642
2	12,804.069	-230,198.615
3	12,804.077	-230,598.613
4	14,804.064	-230,598.613
5	14,804.073	-231,098.574
6	15,804.067	-231,098.556
7	15,804.085	-232,098.549
8	16,004.084	-232,098.546
9	16,004.102	-233,098.540
10	17,804.910	-233,098.507
11	17,804.118	-234,598.498
12	15,804.130	-234,598.534
13	15,804.121	-234,098.537
14	13,804.133	-234,098.573
15	13,804.115	-233,098.579
16	13,004.120	-233,098.594
17	13,004.102	-232,098.600
18	12,804.104	-232,098.604
19	12,804.087	-231,198.609
20	11,304.097	-231,198.636

#### 4.1.1.2 *Semblana Mining Area*

The Semblana Mining Area (Area B) covers 15.4km<sup>2</sup>. A summary of the concession coordinates in the European Terrestrial Reference System (1989) (PT-TM06/ETRS89) is shown in Table 4.2.

Coordinate Point	Easting (m) (ETRS89)	Northing (m) (ETRS89)
1	11,304.057	-228,973.700
2	13,964.140	-228,973.652
3	19,477.190	-233,599.474
4	19,477.221	-235,373.463
5	15,304.147	-235,373.539
6	15,304.124	-234,098.546
7	15,804.121	-234,098.537
8	15,804.130	-234,598.534
9	17,804.118	-234,598.498
10	17,804.091	-233,098.507
11	16,004.102	-233,098.540
12	16,004.084	-232,098.546
13	15,804.085	-232,098.549
14	15,804.067	-231,098.556
15	14,804.073	-231,098.574
16	14,804.064	-230,598.577
17	12,804.077	-230,598.613
18	12,804.069	-230,198.615
19	11,304.078	-230,198.642

#### 4.1.2 Exploration Concession

The Exploration Concession currently covers an area of 105km<sup>2</sup>, excluding the integrated Mining Concession area. A summary of the concession coordinates in the European Terrestrial Reference System (1989) (PT-TM 06/ETRS) is shown in Table 4.3.

Coordinate Point	Easting (m) (ETRS89)	Northing (m) (ETRS89)
1	4,834.244	-230,433.599
2	9,417.809	-225,083.176
3	10,389.127	-224,271.086
4	23,419.205	-233,095.746
5	21,879.287	-234,853.262
6	19,477.262	-237,599.450
7	13,374.628	-237,599.560
8	11,304.097	-231,198.636
9	11,304.078	-230,198.642
10	11,304.057	-228,973.700
11	13,964.140	-228,973.652
12	19,477.190	-233,599.474
13	19,477.221	-235,373.463
14	15,304.147	-235,373.539
15	15,304.124	-234,098.546
16	13,804.133	-234,098.573
17	13,804.115	-233,098.579
18	13,004.120	-233,098.594
19	13,004.102	-232,098.600
20	12,804.104	-232,098.604
21	12,804.087	-231,198.609

Prior to January 13, 2020, EDM had the option to purchase up to 15% participation upon conversion of areas of the Exploration Concession to a mining concession. However, the right to purchase participation has now expired.

#### 4.2 Access Rights and Surface Land Ownership

The SOMINCOR operations in Portugal consist of the following facilities:

- The Neves-Corvo underground mine and associated facilities, mineral processing facilities and central administration offices at the mine site;
- Private warehouses, harbour and loading facility at Setúbal;
- Sand extraction facilities at Alcácer do Sal; and
- Lisbon office.

SOMINCOR owns and has access rights to all the land relating to its facilities except for the Lisbon office which is a leased property.

Sand extraction facilities at Alcácer do Sal cover an area of 201.60 ha and has a dedicated valid concession.

The warehouse facilities at the port of Setúbal are owned by SOMINCOR while the private harbour and loading facility at Setúbal are under a concession agreement for 30 years which commenced on January 1, 1996.

#### **4.3 Royalties**

Royalty payments to the Portuguese State are detailed in Section 4.1.1.

All silver contained in the concentrates from Area A belongs to Wheaton Precious Metals Corp. under a silver streaming agreement signed with Silverstone Resources (since acquired by Wheaton Precious Metals Corp.) in 2007 and is invoiced separately when the silver content reaches payable levels.

#### **4.4 Taxes**

The corporate taxation rate in Portugal is 21%.

#### **4.5 Environmental Aspects**

A summary of the valid environmental permits obtained by SOMICOR and related obligations are detailed in Section 20.

Some of the industrial area of Neves-Corvo falls within the National Ecological Reserve (REN) and approval for activities within this area need to be applied for.

An updated Mine Closure Plan was submitted to DGEG in December 2022.

The authors are not aware of any environmental liabilities relating to the Neves-Corvo Mine.

#### **4.6 Other Permits**

As a result of the ZEP, an Industrial License update was completed on April 20, 2022. Other relevant permits are detailed in Section 20.

The authors are not aware of any other significant factors and risks that may affect access, title, or the right or ability to perform work on the Neves-Corvo Mine.

## **5 ACCESSIBILITY, CLIMATE, LOCAL RESOURCES, INFRASTRUCTURE AND PHYSIOGRAPHY**

### **5.1 Accessibility**

The Neves-Corvo Mine is connected to the national road network and is approximately a one-hour drive from Faro to the south or one and a half hours from Lisbon to the northwest. The A2 highway is located within 25km of the mine site and is accessed by a paved road. In addition, the mine has a dedicated railhead to the Portuguese rail network and the port of Setúbal where the mine has a private harbour facility for concentrate shipments. International airports are located at Faro (approximately 80km to the south) and Lisbon (approximately 200km to the northwest). There are no major centres of population close to the mine, although several small villages including Neves da Graça, Senhora da Graça de Padrões and A-do-Corvo with populations of up to 100 are found within the Neves-Corvo Mining Concession. The nearest larger towns are Castro Verde and Almodôvar (both with populations of around 7,000) located 18km to the northwest and 11km to the southwest, respectively.

### **5.2 Climate**

The climate of the region is Mediterranean with an average annual temperature of 17°C. The average temperature in July is 25°C while the average temperature in January is 10°C. Temperatures below freezing are rare. Rainfall occurs predominantly from October through April. Average annual rainfall is typically 240mm, however this is highly variable year on year. Most rainfall occurs from October through February with little or no rainfall occurring during the summer months.

### **5.3 Local Resources**

There is an extensive network of paved highways, rail service, excellent telecommunications facilities, national grid electricity, an ample supply of water and a highly educated work force. The area supports low intensity agriculture confined to stock rearing and the production of cork and olives.

### **5.4 Infrastructure**

Infrastructure associated with the Neves-Corvo Mine includes:

- Underground mine;
- Mine portal and decline;
- Winder house, headframe and hoisting shaft;
- Two mineral processing plants (Copper Plant and Zinc Plant);
- Paste and hydraulic backfill plants;
- Ore stockpiles;
- Waste dump;
- Cerro do Lobo Tailings Storage Facility;
- Cerro da Mina Water Storage Facility (lined) (storage of surplus water from the mine);
- Catch ponds (surface run-off);

- Water treatment plant and reverse osmosis plant;
- Process plant water storage tanks;
- Laboratory;
- Truckstop and truck wash;
- Workshops and mine store;
- Mine office and change house;
- Cafeteria;
- Medical services facility;
- Electrical substation;
- Weighbridge;
- Security gatehouse;
- Administration offices;
- Lombador exploration facility; and
- Railway and terminals for concentrate shipment.

Other infrastructure associated with the operation includes the private harbour facility at the port of Setúbal for concentrate shipments, sand extraction facilities at Alcácer do Sal and an office in Lisbon.

#### **5.4.1 Power**

The mine is connected to the national grid by a single 150kV, 50MVA rated, overhead power line that is approximately 22.5km in length.

#### **5.4.2 Water**

The operation has an efficient water management system which maximises recycling of water and transfer between the mining and mineral processing operations and TSF. Where necessary, fresh water is supplied to the mine via a 400mm diameter pipeline from the Santa Clara reservoir, approximately 40km west of the mine. Supply capacity is 600m<sup>3</sup>/hr whilst storage facilities close to the mine hold 30 days' requirements. The average current total freshwater requirement for the site operations is approximately 100m<sup>3</sup>/hr. In 2022, around 92% of the water used by the industrial process was recycled water.

### **5.5 Physiography**

The topography around the mine is relatively subdued, comprising low hills with minimal rock outcrop. The mine shaft collar is 210m above sea level (masl). Vegetation in the project area includes scrubland and holm oak with some areas used for low intensity agriculture including stock rearing, arable crops, cork, olives and fruit trees (where irrigation is available). Areas of meadow and pastures are also present.

The authors are of the opinion that there is sufficient land, water, and power for the planned mining and processing operations.

## 6 HISTORY

### 6.1 Ownership and Development History

Mineralisation at Neves-Corvo was discovered in 1977 following an exploration joint venture between Sociedade Mineira de Santiago (legally succeeded by EMMA – subsequently renamed EDM), Societe d'Etudes de Recherches et d'Exploitations Minières (SEREM) and Société Minière et Metallurgique de Peñarroya, S.A. (SMMP), through which exploration drilling was undertaken to test a number of favourable gravity anomalies. Following discovery, SOMINCOR was formed to exploit the deposits. The shareholders were EDM 51%, SMMP 24.5% and Coframines 24.5%.

Rio Tinto became involved in the project in 1985 effectively forming a 49:51% joint venture with the Portuguese government (EDM). This change in shareholding led to a reappraisal of the project with eventual first production commencing from the Upper Corvo and Graça orebodies on January 1, 1989, achieving 1.0Mt of throughput in that year. Total capital cost for the mine was approximately US\$350M.

During the development of the mine, significant tonnages of high-grade tin ores were discovered, associated with the copper mineralisation, which led to the rapid construction of a Tin Plant at a cost of approximately US\$70M. The plant was commissioned in 1990 and in that year some 270,000t of tin-bearing ore was treated.

The railway link through to Setúbal was constructed between 1990-1992 to allow shipment of concentrates and the back-haul of sand for fill. This was followed between 1992-1994 by a major mine deepening exercise, at a cost of US\$33M, to access the Lower Corvo orebody through the installation of an inclined conveyor ramp linking the 700m and 550m levels. Access to the orebody of North Neves was also completed in 1994 and significant production tonnage has since come from this area.

On June 18, 2004, EuroZinc acquired a 100% interest in SOMINCOR. The consideration paid was €128,041,000.

In 2006, zinc production commenced at Neves-Corvo with processing through the modified Tin Plant.

On October 31, 2006, EuroZinc was acquired by LMC, and subsequently amalgamated with LMC effective November 30, 2006.

In June 2007, Silverstone Resources Corporation (subsequently acquired by Wheaton Precious Metals Corp.) agreed to acquire 100% of the life of mine payable silver production from Neves-Corvo (Area A). The mine is expected to produce between 0.7 and 1.2 Moz of payable silver annually in the copper concentrate.

In November 2008, zinc production was suspended due to the low prevailing zinc price. In mid-2009, a copper tailings retreatment circuit was commissioned to recover both copper and zinc, and in late 2010, tailings disposal changed from subaqueous to paste methods at the Cerro do Lobo TSF.

In September 2009, the decision was made to expand the Zinc Plant at an estimated cost of €43M, to a nominal design capacity of 1.0 Mtpa of zinc ore. The plant was commissioned in the second half of 2011. Lead concentrate production commenced in 2013 when improvements in lead processing were implemented enabling a saleable lead concentrate to be produced.

In 2015, and amended in 2017, a Feasibility Study on the ZEP was completed by LMC to expand zinc mining and processing capacity from 1.1 to 2.5Mtpa. Expansion of zinc production was planned for all existing zinc producing areas of the mine and particularly: Corvo, Graca, Neves and Lombador Phase 1 (LP1) (to a depth of approximately 1,000m below surface). Lombador Phase 2 (LP2) is situated down-dip of LP1 at depths of approximately 1,000m to 1,200m below surface and required a new materials handling system to connect this area of the mine with the hoisting shaft and this was included as part of the ZEP. The overall scope of the ZEP infrastructure consisted of the following:

- A new primary crusher station on the 280 level including jaw crusher, rock breaker, vibrating grizzly feeder, shuttling silo distribution conveyor, magnetic separator and ancillary equipment;
- 2.9km of new ramp conveyor systems in three legs to connect LP2 with the existing 700 level crusher station and hoisting shaft;
- Upgrade to services at the existing crusher station and hoisting shaft area on the 700 level;
- Upgrade to the hoisting shaft and skip loading system to increase its capacity from 4.9Mtpa to 5.6Mtpa;
- Ventilations system including a new surface shaft and mobile cooling units due to higher rock temperatures at increased depths;
- Expansion of associated mine services (electrical, water, pumping and communications);
- Expansion of the Zinc Plant capacity from 1.15 to 2.5Mtpa, including a new building for grinding (SAG Mill) and flotation and upgrades to flotation in the existing Zinc Plant;
- Expansion and upgrades to lead concentrate dewatering facilities;
- Expansion and upgrades to existing surface infrastructure facilities;
- Expansion of the Cerro do Lobo TSF.

ZEP infrastructure was substantially completed by Q1 2022 by the commissioning of the material handling system and processing plant upgrade. Some of the remaining projects under the ZEP scope after the main system commissioning are paste fill expansion and CPV23 raise. Following ramp-up, full production of zinc concentrates from the ZEP is planned for Q1 2024.



## 6.2 Exploration History

From 1973 to 1984 the joint venture between the Portuguese government (EDM) (51%), SMMP (24.5%) and Conframines (24.5%) completed a total of 258 drillholes for 120,039m during the discovery stage of the project.

From 1985 to 2003, during the joint venture between Rio Tinto and EDM, a total of 3,259 drillholes for 412,165m were completed during the feasibility and mine expansion phase of the project.

On June 18, 2004, EuroZinc acquired a 100% interest in SOMINCOR. During this phase a total of 566 drillholes for a total of 62,255m were completed.

On October 31, 2006, LMC acquired EuroZinc. A total of 6,748 drillholes (surface and underground) for a total of 1,109,838m have been drilled by LMC up to June 30, 2022. Underground drilling is continuously ongoing at the mine and focusses on near-mine resources while surface drilling campaigns are used to identify extensions of mineralisation in the vicinity of the known deposits and test regional exploration for new deposit clusters.

In October 2010, surface exploration drilling on a prospective area close to the Neves-Corvo mine discovered the Semblana deposit, comprising mainly copper stockwork, located 1.3km to the northeast of Zambujal. A maiden Mineral Resource estimate for Semblana was published by LMC in December 2011 and this was updated (with additional drilling) in September 2012.

On July 25, 2012, LMC issued a press release on the discovery of the Monte Branco deposit, located 1.2km south of Semblana and to the west of the Cerro do Lobo TSF. Monte Branco represented a new centre of concentrated sulphide mineralisation, covering approximately 250m by 200m in area, including both massive and stockwork type sulphides which were intercepted at approximate depths of 540m to 700m below surface. Resource definition surface drilling at Monte Branco was undertaken until approximately the end of Q1 2014.

In May 2017, following a hiatus in surface exploration drilling at Neves-Corvo during 2015-2016, surface drilling was resumed, firstly focusing on near-mine targets that could be developed in 2-3 years. After granting of the Exploration Concession in June 2018, surface drilling has continued with further testing of near-mine targets for extensions of mineralisation adjacent to the known deposits and also testing of regional geological and geophysical targets in the exploration concession to explore for new deposit clusters. Further information on exploration by LMC is detailed in Section 9.

A summary of the historical exploration drilling (surface and underground) is shown in Table 6.1. The reported numbers do not include geotechnical drilling.

**Table 6.1: History of Exploration Drilling**

EDM, SMMPP, Conframines			EDM, Rio Tinto			Eurozinc			LMC		
Year	No. Drillholes	Meters (m)	Year	No. Drillholes	Meters (m)	Year	No. Drillholes	Meters (m)	Year	No. Drillholes	Meters (m)
1973	2	747	1985	52	13,238	2004	164	13,485	2007	219	44,702
1977	6	2,669	1986	186	23,485	2005	169	19,240	2008	265	57,237
1978	26	12,820	1987	199	23,140	2006	233	29,530	2009	244	62,800
1979	25	14,129	1988	127	17,346	<b>Total</b>	<b>566</b>	<b>62,255</b>	2010	304	77,123
1980	31	17,543	1989	189	20,504				2011	384	117,656
1981	31	17,850	1990	136	14,040				2012	390	132,915
1982	37	20,542	1991	166	24,244				2013	336	97,581
1983	35	16,356	1992	176	29,485				2014	199	41,261
1984	65	17,383	1993	225	32,404				2015	412	50,887
<b>Total</b>	<b>258</b>	<b>120,039</b>	1994	93	14,837				2016	363	23,010
			1995	188	28,063				2017	590	58,271
			1996	236	33,052				2018	530	72,619
			1997	165	22,998				2019	521	91,178
			1998	179	22,603				2020	416	39,800
			1999	182	20,690				2021	727	57,213
			2000	196	20,989				2022	848	85,585
			2001	203	17,902				<b>Total</b>	<b>6,748</b>	<b>1,109,838</b>
			2002	162	15,871						
			2003	199	17,274						
			<b>Total</b>	<b>3,259</b>	<b>412,165</b>						

## 6.1 Production History

Commercial production has been continuous at the Neves-Corvo Mine since 1989. A summary of the ore processed by the copper and Zinc Plants is shown in Table 6.2.

**Table 6.2: Neves-Corvo Mine Copper and Zinc Production**

Year	Copper Ore Processed (kt)	Head Grade (Cu %)	Zinc Ore Processed (kt)	Head Grade (Zn %)
1989	1,003	11.2	-	-
1990	1,590	10.6	-	-
1991	1,648	10.1	-	-
1992	1,524	10.3	-	-
1993	1,610	9.8	-	-
1994	1,587	8.8	-	-
1995	1,790	7.9	-	-
1996	1,838	6.4	-	-
1997	1,812	6.4	-	-
1998	2,181	5.8	-	-
1999	2,128	5.2	-	-
2000	1,614	5.3	-	-
2001	1,942	4.9	-	-
2002	1,739	5.1	-	-
2003	1,679	5.4	-	-
2004	1,882	5.7	-	-
2005	2,041	5.0	-	-
2006	1,947	4.6	148	8.4
2007	2,181	4.8	397	7.8
2008	2,410	4.3	399	7.3
2009	2,570	3.9	-	-
2010	2,475	3.4	100	5.7
2011	3,198	2.7	63	6.4
2012	2,512	2.6	543	7.3
2013	2,525	2.6	974	7.1
2014	2,503	2.5	1,102	8.0
2015	2,542	2.7	1,014	8.0
2016	2,386	2.5	1,039	8.2
2017	2,121	2.1	1,000	9.7
2018	2,692	2.2	1,125	7.8
2019	2,679	2.0	1,137	7.9
2020	2,427	1.7	1,106	8.1
2021	2,564	1.9	1,060	7.8
H1 2022	1,296	1.8	719	6.9

## 7 GEOLOGICAL SETTING AND MINERALISATION

### 7.1 Regional Geology

The Neves-Corvo Mine is located in the western part of the Iberian Pyrite Belt (IPB) which has historically hosted numerous major stratiform VMS deposits including Rio Tinto, Aguas Teñidas, Las Cruces, Tharsis, La Zarza, Los Frailes and Aljustrel.

The IPB formed within a basin located on the passive margin of the South Portuguese Zone (SPZ) that underwent northward oblique subduction and later obduction with the autochthonous Iberian Terrane (Ossa-Morena Zone) in the Upper Devonian. The oblique nature of the collision under a compressive sinistral transtensional regime promoted the development of pull-apart basins leading to the formation of a major volcanic belt, the IPB, within a highly compartmentalised sedimentary basin located on the outermost margin of the SPZ. To the north, the IPB is in contact with the Pulo do Lobo accretionary prism and ophiolites, while to the south the IPB is thrust over the Baixo Alentejo Flysch Group (also termed the Culm Group). The complex geological configuration of the IPB has been generated by intense folding, thrusting and faulting during the Variscan orogeny. The following descriptions are based on Leistel et al. (1998).

The location of the Neves-Corvo Mine and the regional geology is shown in Figure 7.1.

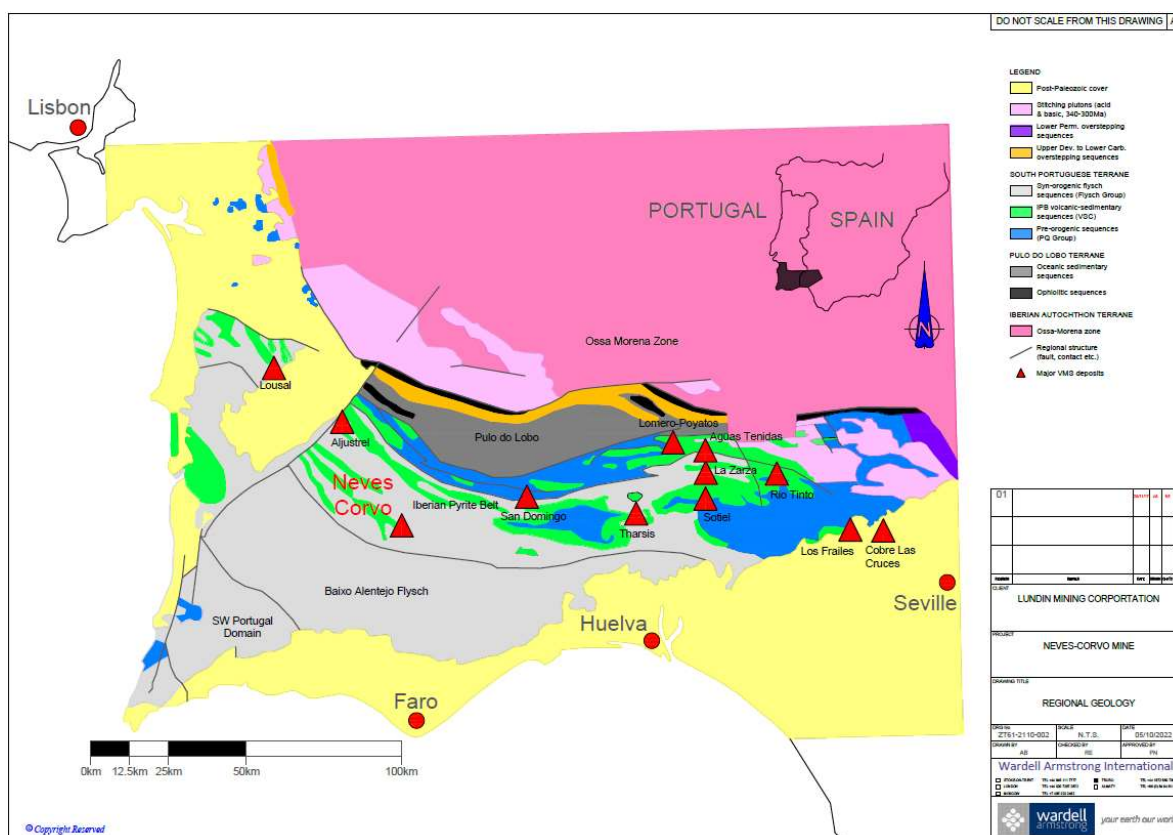

Figure 7.1: Location of Neves-Corvo Mine, Regional Geology and Principal Deposits

### **7.1.1 Stratigraphy**

The type stratigraphic column of the IPB includes Palaeozoic (Upper Devonian-Carboniferous) rocks which reflect the evolution of the basin during the pre-orogenic and synorogenic stages of the Variscan orogeny. Three main lithostratigraphic groups are present: the Phyllite-Quartzite (PQ) Group, the Volcanic-Sedimentary Complex (VSC) and the Baixo Alentejo Flysch Group.

#### *7.1.1.1 PQ Group*

At the base, the IPB consists of a pre-orogenic sequence of shales and arenites (phyllites and quartzites) known as the PQ Group that developed by marine deposition on a stable shallow epicontinental shelf. The extent at depth of the group remains unknown, although estimates of the thickness indicate several thousand metres. Limestone lenses near the top of the succession have provided conodonts and other fossils of Upper Devonian age. The top of the PQ Group is marked by a major sedimentary break resulting from a rupture of the platform leading to an increase in clastic content and the development of a very heterogeneous facies, including shallow to sub-aerial reef limestones, delta-related deposits and mass flow deposits. Rocks of the PQ Group were affected by pervasive regional hydrothermal alteration.

#### *7.1.1.2 VSC*

The PQ Group is conformably overlain by a volcanic-sedimentary succession, the VSC, of Late Devonian-Early Carboniferous age, 360-342Ma (Relvas et al., 2006). The VSC comprises a heterogeneous group of rocks that display rapid lateral and vertical facies changes. Rock sequences consist of both felsic and mafic (bimodal) volcanics interfingering with an envelope of detrital and chemical sediments. Volcanic rocks are mainly felsic pyroclastic rocks and mafic flows. Subvolcanic rocks, both felsic and mafic, are ubiquitous, comprising in some places the bulk of the stratigraphic column. Sedimentary rocks comprise three main types: volcanic-derived epiclastites whose grain sizes range from conglomerates to silts; black shales; and chemical sedimentary rocks including massive sulphides and manganese cherts and jaspers. The entire VSC sequence was also affected by pervasive regional hydrothermal alteration.

Mineralisation is interbedded within the VSC and occurs as lenses of polymetallic massive sulphides derived from metal enriched fluids associated with submarine volcanics. Focused hydrothermal alteration is subsequently evident in footwall rocks. Massive sulphide deposition is generally coincident with an anoxic environment and as such massive sulphides can be hosted directly in black shale (e.g. at Tharsis and Sotiel). In some instances, massive sulphides overlie felsic volcanic facies (e.g. at Rio Tinto and La Zarza), albeit commonly separated from the felsic volcanics by a thin pelitic layer.

#### *7.1.1.3 Baixo Alentejo Flysch Group*

Conformably overlying the VSC are the Baixo Alentejo Flysch Group rocks characterised by a thick Upper Carboniferous succession of turbidites of argillite, siltstone and greywackes. The estimated

thickness of this group exceeds several thousand metres. The Baixo Alentejo Flysch Group represents the infill of a rapidly subsiding basin, mostly by sediments derived from the VSC and the Ossa-Morena Zone.

### **7.1.2 Structural Geology**

The structural evolution of the IPB comprises a northeastward Variscan subduction under the Ossa-Morena Zone, beginning in the Lower Devonian, followed by continental collision with the SPZ (from the Famennian to middle Westphalian). The Pulo do Lobo antiform represents an accretionary prism delineating a geotectonic suture resulting from oblique Lower Devonian to Lower Carboniferous subduction followed by continental collision. The Ossa-Morena Zone and the previously accreted Pulo de Lobo Zone were obducted together southwards onto the newly accreted SPZ during the collisional stage.

The IPB is located on the outermost margin of the SPZ and was subjected to a compressive transtensional regime during the initial phase of oblique collision. Extension resulted in the formation of pull-apart basins and grabens creating crustal thinning and mantle upwelling. Within this highly compartmentalised basin, deposition of the volcanic-sediments and associated massive sulphide mineralisation of the VSC occurred. The IPB was accreted with the Pulo de Lobo and Ossa-Morena Zones during the Upper Devonian to late Viséan when subduction of the oceanic basin was completed.

The complex geological configuration of the IPB has been generated by intense folding, thrusting and faulting during the Variscan orogeny. Anticlinal folds trend northwest and verge to the southwest while thrust faults appear to have removed the associated synclines. The massive sulphide orebodies exhibit features of intense deformation and are located on deep fractures that acted as feeders for the hydrothermal fluids. The fractures were reactivated during the collisional stage and formed thrust planes. Thrusting has resulted in instances where stacking of the massive sulphides results in repetition and thickening of the mineralised zones.

Late Variscan north-northwest to northeast trending faults offset the folded and thrust stratigraphy sometimes with offsets of hundreds of metres, although displacements are usually much smaller. Very low to low grade regional metamorphism was associated with the Variscan orogeny. A cross section showing the geological structure of the SPZ is shown in Figure 7.2.

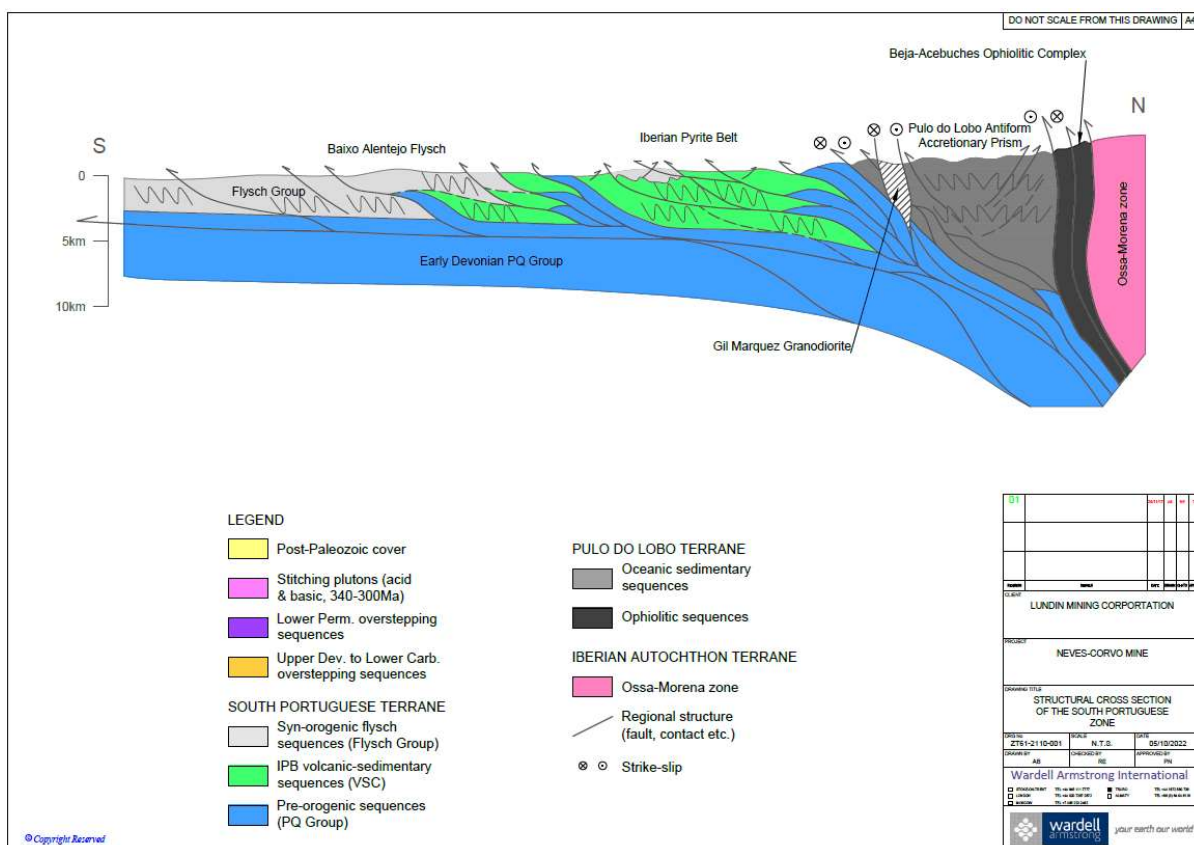

Figure 7.2: Structural Cross Section of the South Portuguese Zone

### 7.1.3 Mineralisation

The basic process of formation of massive sulphide deposits, as syngenetic accumulations on or near the seafloor, is the primary control over mineralisation. Sulphide or sulphate minerals are deposited from hydrothermal fluids generally associated (although not always) with volcanic centres in settings analogous to current active seafloor vent systems.

The main mineralisation types are massive sulphides and stockworks. The massive sulphides are stratiform and, by definition, contain zones or lenses of massive sulphide minerals, many with sulphide mineral contents exceeding 90% by volume. Most deposits also contain extensive zones of semi-massive sulphide (25% to 50% by volume). Disseminated sulphide mineralisation can be extensively developed in footwall alteration zones; sulphide mineral abundances decrease with depth below the massive sulphide zone horizon. Lateral development of disseminated pyrite can be continuous for large distances at and immediately below the stratigraphic horizon of the massive sulphide lens.

In deposits that have not been tectonically disrupted, stockwork mineralisation is confined almost exclusively to the stratigraphic footwall of the massive sulphides representing probable feeder zones for the hydrothermal fluids. Stockwork zones typically contain 5% to 20% sulphide minerals by volume, hosted in quartz veins and disseminated in chloritic wall rocks. Stockwork zones exhibit intense hydrothermal alteration including silicification, sericitisation and chloritisation.

Metal zoning is well developed in massive sulphide deposits. Copper abundances are elevated in footwall and stockwork zones and zinc contents increase upwards and outward from the core of the hydrothermal upwelling zones. In felsic-associated deposits, lead, arsenic and antimony abundances are enriched upward and outward from the zinc rich zones. Barite and silica can also be enriched towards the stratigraphic tops and most distal zones.

The mineralisation types can be further subdivided into: pyritic (barren pyrite), polymetallic and copper-pyritic. All three types can occur within the massive sulphide or stockwork mineralisation, however of these, copper-pyritic is more common in stockworks, whereas polymetallic is prevalent in massive sulphides. Within the massive sulphides the relationship between the polymetallic and pyritic ore types can be complex. In many cases the boundaries between ore grade mineralisation and barren pyrite can be abrupt and parallel to the stratigraphic contacts of the sulphide lens.

Mineralisation related to oxidation and/or re-mobilisation of primary massive sulphides and stockworks can occur where the weathering profile is preserved and includes supergene enriched zones and gossans which are often enriched in gold and silver (this type of enriched mineralisation is found at the Las Cruces mine).

The most common mineral associations are formed by pyrite, chalcopyrite, sphalerite and galena as major minerals in different proportions, and by arsenopyrite, tetrahedrite, enargite, barite, magnetite, pyrrhotite, hematite, cassiterite, stannite, bournonite, jamesonite, gold, and bismuth, as the second most common minerals. Covellite, chalcocite, goethite, lepidocrocite, jarosite, scorodite, and bornite are minerals formed by supergene enrichment. They exist in the outer surface layer of ore bodies or in the magnetite cap. Bismuth-bearing minerals (wittichenite, bismuthinite, aikinite and kobellite), antimony-bearing minerals (gudmundite, boulangerite, meneghinite), and sulfoarsenides (cobaltite) are rarely found.

## **7.2 Local and Property Geology**

The Neves-Corvo stratigraphic sequence includes the PQ Group, the Volcano-Sedimentary Complex (VSC) and the Baixo Alentejo Flysch Group. The massive sulphides are located near the top of a dominantly volcanic sequence of the VSC, which consists of two chemically distinct intervals of felsic volcanics separated by shale units. A discontinuous black shale horizon is present immediately below the massive sulphide lenses.

The stratigraphy is affected by a complex structural setting resulting from a change in tectonic regime (extensional to compressive) during the Variscan orogeny. The whole geological assemblage has been folded into a gentle anticline, termed the Ro ario-Neves-Corvo anticline, and is orientated northwest-southeast and plunges to the southeast. Neves-Corvo is located at the southeastern termination of this anticline and the mineralised zones are distributed on both limbs of the fold. All stratigraphic units have been affected by northwest trending and southwest verging folds with associated cleavage and low angle thrusting. The direction of tectonic transport of the thrusts is to the southwest and disrupts the stratigraphy, producing nappe package repetitions and thickening of the massive sulphides. Of



these, the Neves-Corvo Main Thrust is the most significant and divides the VSC into an allochthonous upper sequence and an autochthonous lower sequence.

All geological units and Variscan structures, including thrusts, are affected by near-vertical, extensional, oblique strike-slip faults. The faults trend northeast to north-northwest and reflect a change from compressive to extensional tectonic regime associated with the late Variscan.

The geology of the Neves-Corvo area is shown in Figure 7.3.

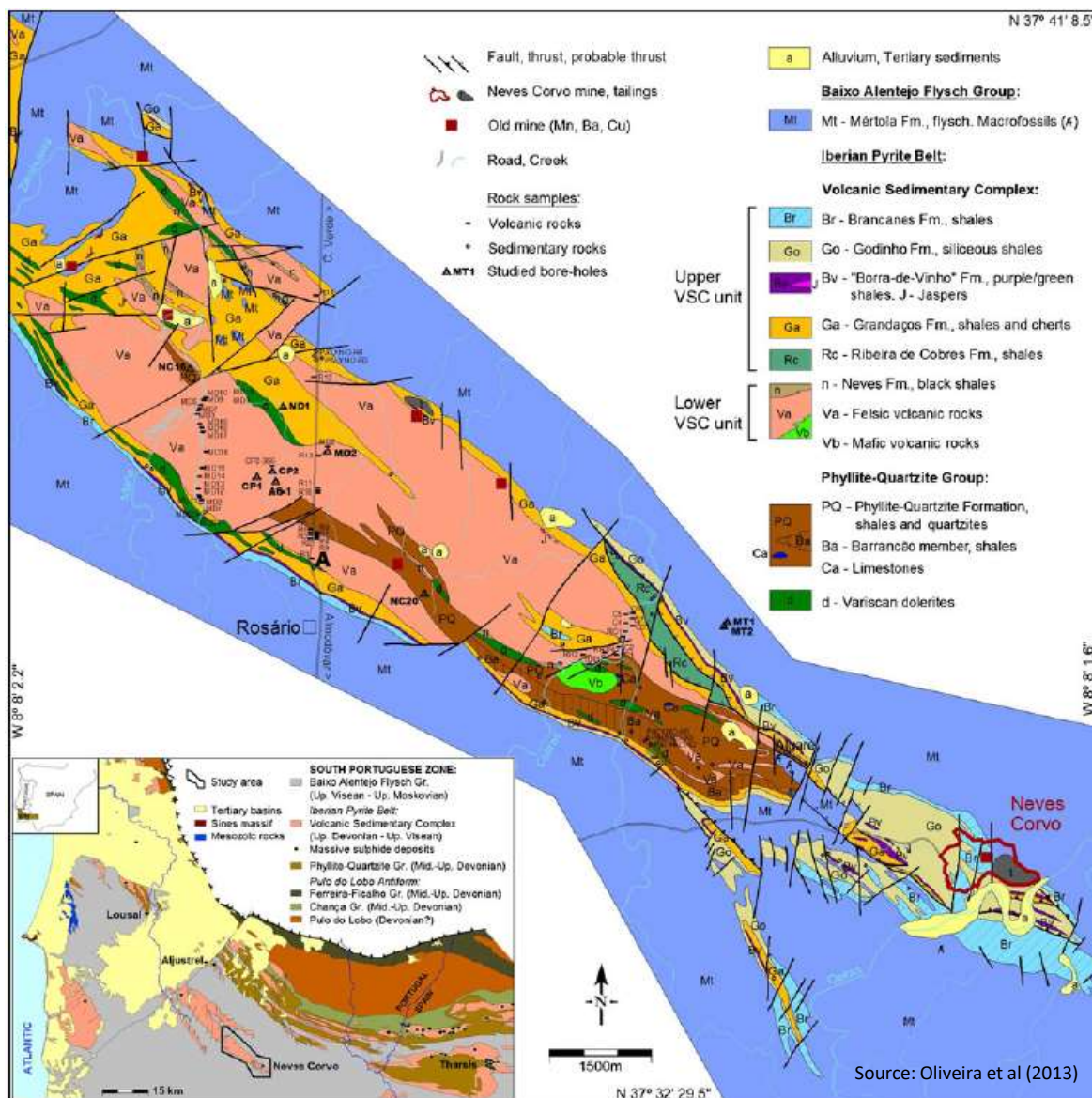

Figure 7.3: Geology of the Neves-Corvo Area

### 7.2.1 Stratigraphy

The PQ Group is the lowermost unit in the mine area and is represented by dark shales with siliceous lenses and nodules of the Barrancão member which are in turn overlain by shales, siltstones, and

quartz-sandstones of the PQ Formation. The unit's thickness is in excess of 100m (base not known) with the top of the unit being of late Famennian age. The top of the PQ formation marks the transition to the lower VSC, here limestone lenses several metres thick occur, which are interbedded in shale.

The VSC is divided into a lower (autochthonous) sequence and an upper (allochthonous) sequence, separated by the Neves-Corvo Main Thrust.

The lower VSC sequence, of late Famennian to late Strunian, consists of rhyolites, rhyodacites, volcaniclastic sedimentary rocks, basalts, dolerite sills, dark shales (Neves Formation) and intercalations of black shales, carbonate nodules and volcanogenic sediments (Corvo Formation), hosting VMS deposits on top with an upper layer of jaspers and carbonates which represent the immediate hangingwall of the massive sulphides. The thickness of the lower VSC sequence varies depending on the distribution of the volcanic facies and may reach up to 500m. Within the mine area the lower VSC sequence is unconformably overlain by turbidites (greywackes and shales) of the Mertola Formation (Mt2) of late Visean age with thickness varying from a few metres to several tens of metres. The time gap between the Mertola Formation (Mt2) and the underlying lower VSC sequence has been related to submarine erosion that removed all Tournaisian age sediments. Given its proximity to the massive sulphides of the lower VSC sequence, the unconformable Mertola Formation (Mt2) is used as a tectonic marker for mineral exploration.

Overlying the unconformable Mertola Formation (Mt2) is the upper VSC sequence which has been transported over the Mertola Formation (Mt2) by the Neves-Corvo Main Thrust. The upper VSC sequence consists of several shale-based formations including: the Grandaços Formation (dark shales with phosphate nodules, cherts and fine volcanogenic sedimentary rocks), the Borra de Vinho Formation (purple shales), Graça Formation (grey siliceous and black shales rich in phosphate nodules), Godinho Formation (shales, siliceous shales and felsic volcaniclastic rocks) and Brancanes Formation (dark shales and thin-bedded greywackes). The upper VSC sequence has an overall thickness of greater than 300m and is early to late Visean age.

The upper VSC sequence is conformably overlain by massive greywacke beds, and dark grey/black shales (turbidites) of the Mertola Formation (Mt1, Mt2, and Mt3) which is the lower unit of the Baixo Alentejo Flysch Group and of late Visean age.

An example of the stratigraphic sequence at Neves-Corvo is shown in Figure 7.4.

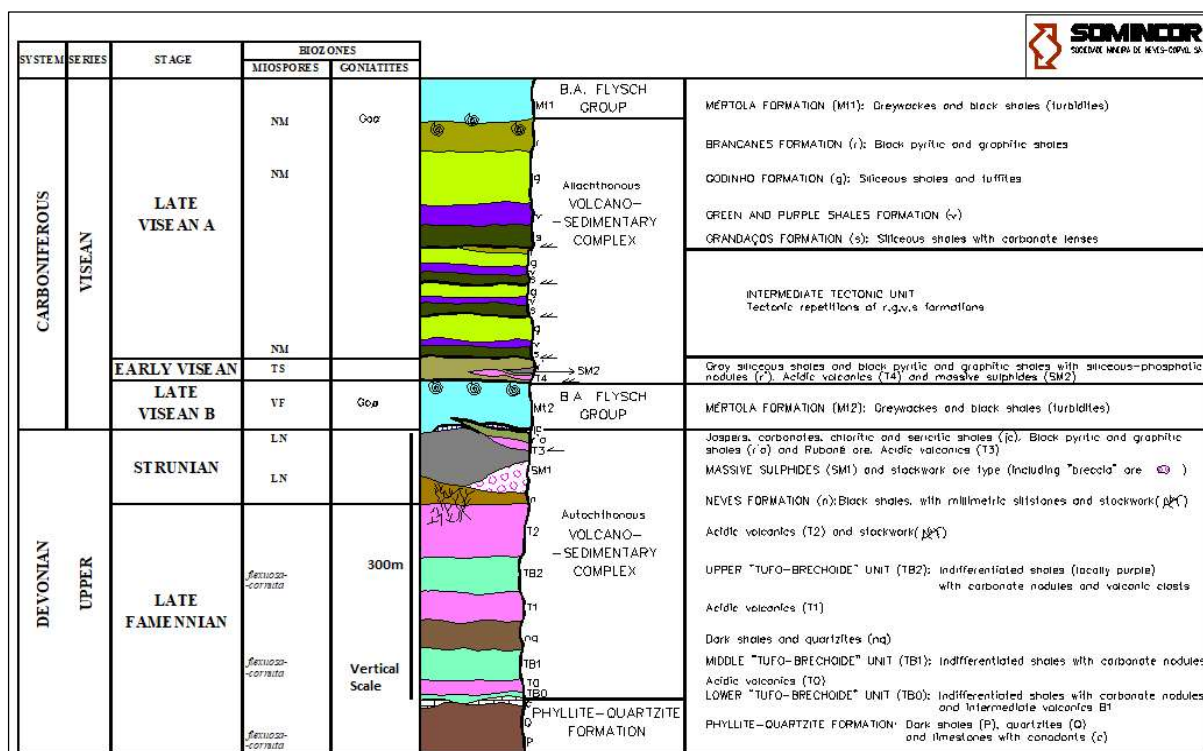
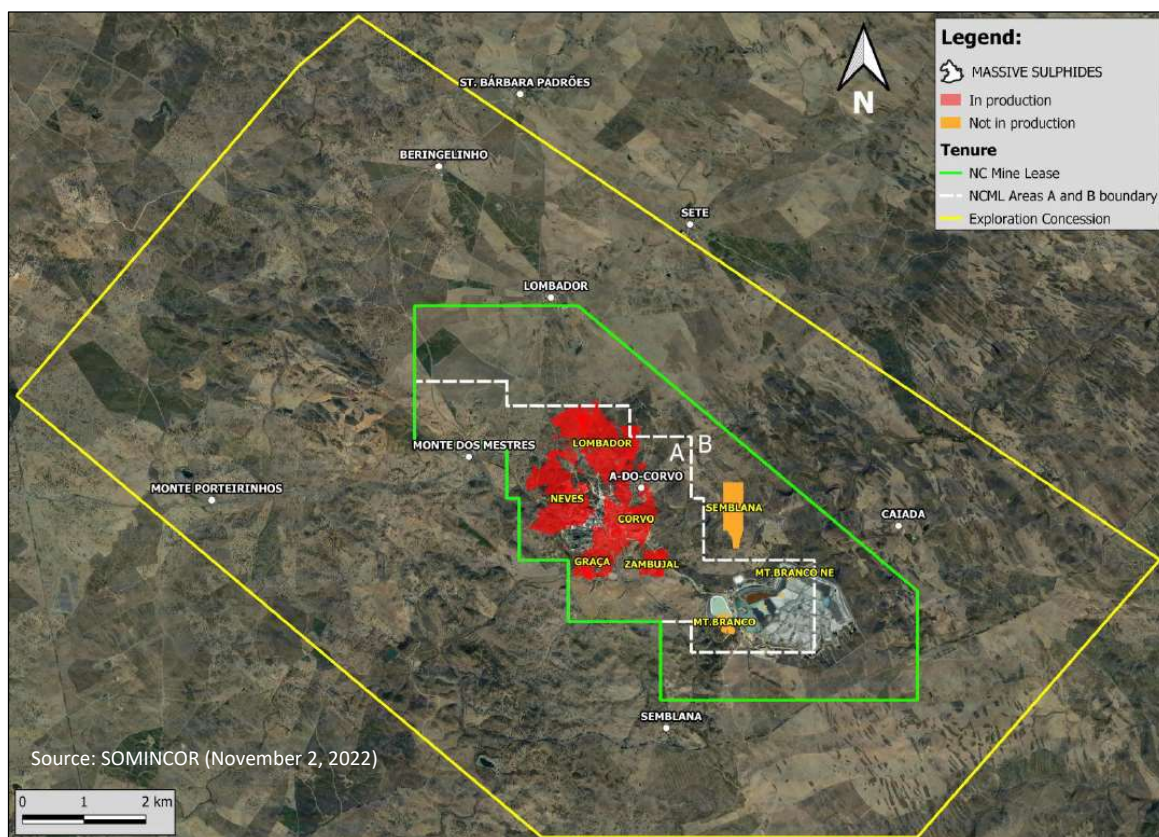

Figure 7.4: Stratigraphic Sequence of Neves-Corvo

### 7.3 Mineralised Zones

Seven massive sulphide deposits are present and include: Neves, Corvo, Graça, Zambujal, Lombador, Monte Branco and Semblana.

The deposits lie on both flanks of the Roário-Neves-Corvo anticline. Neves, Corvo, Graça, Zambujal and Lombador sulphide lenses are conformable with the stratigraphy and are connected by stockwork 'bridge zones' mostly over the crest of the fold. This has resulted in an almost continuous complex volume of mineralised rock showing a large range in both styles of mineralisation and geological structure. Drilling has demonstrated that no significant continuous mineralised 'bridge' exists from Zambujal to Semblana or Monte Branco. The mineralised zones are located at depths of 230m to 1,400m below surface. The locations of the zones are shown in Figure 7.5.



**Figure 7.5: Location of Mineralised Zones at Neves-Corvo Mine**

The deposits occur as concentrations of high-grade copper and/or zinc mineralisation in massive sulphide pyritic lenses, and copper mineralisation within stockwork zones that typically underlie the massive sulphides. Base metal grade distributions within the massive copper/zinc sulphide lenses typically show good internal continuity, but laterally can terminate abruptly in barren pyrite. The massive sulphide deposits are generally very large, regular and continuous. However, the geometry of the high-grade zinc and copper zones within the deposits can be very complex. In many cases, boundaries between economic mineralisation and barren pyrite may be almost parallel to the stratigraphic contacts of the sulphide lens.

Three styles of mineralisation are present:

- Rubané mineralisation - characterised by thin banded alternations of shales, breccias and massive sulphide or tin Mineralisation (found mainly in Corvo but now predominantly mined out);
- Massive sulphide mineralisation; and
- Stockwork (fissural) sulphide mineralisation.

The classifications used to determine the mineralisation types are shown in Table 7.1 and includes three barren or low-grade classes.

<b>Mineralisation Type</b>	<b>Description</b>	<b>Major Ore Mineral</b>
MC	Massive Copper	Chalcopyrite
MT	Massive Tin	Cassiterite
MZ	Massive Zinc	Sphalerite
MP	Massive Lead	Galena
FC	Stockwork Copper	Chalcopyrite
FT	Stockwork Tin	Cassiterite
FZ	Stockwork Zinc	Sphalerite
5C (MCZ)	Massive Copper and Zinc	Chalcopyrite/Tennantite - Tetrahedrite/Sphalerite
5Z (MZP)	Massive Zinc and Lead	Sphalerite and Galena
RT	Ruban� Tin	Cassiterite
RZ	Ruban� Zinc	Sphalerite
ME	Massive Pyrite	Barren/Low Grade
FE	Stockwork Pyrite	Barren/Low Grade
RE	Ruban� Pyrite	Barren/Low Grade

Due to the structural complexity of the orebodies, different mineralisation types are often juxtaposed, even over short distances both vertically and laterally. Zonation in the massive sulphide lenses is typically either copper or zinc, although they do occur together in some areas. Zinc-rich zones are typically found near the stratigraphic top of the massive sulphides while copper-rich zones tend to be found at the base. This zoning is interpreted to be a result of primary metal re-zoning caused by temperature, pressure and chemical gradients soon after deposition. In a general sense, grade continuity is better within the massive sulphide lenses than it is within adjacent stockwork and “bridge” zones. The geometry of the copper mineralisation tends to be more complex than that of the zinc mineralisation.

Massive, cassiterite rich, tin mineralisation is associated with the rich copper mineralisation and in the copper rich ruban . The tin mineralisation (now largely depleted by mining) was mainly found in the Corvo orebody, associated with north-south faults along a north-south oriented corridor. The underlying stockwork also contained tin mineralisation.

The following mineralogical and morphological descriptions relate to the orebodies in their original state, prior to mining.

#### **7.4 Corvo**

The Corvo orebody lies between 230m-800m below surface, dips to the northeast at 10-40° and has a strike of approximately 600m. The orebody attains a maximum thickness of 95m and consists of a basal layer of copper ore up to 30m thick, overlain by barren pyrite containing intermittent lenses of copper mineralisation.

The main massive sulphide orebody is overlain by a complex mineralised sequence known as Ruban  which comprises an assemblage of chloritic shales, siltstones and chert-carbonate breccias that are all mineralised with cross-cutting and bedding-parallel sulphide veinlets and occasional thin lenses of

massive sulphides. The Rubané mineralisation which historically contributed over 15% of the total copper content of Corvo, is now predominantly mined out. Rubané mineralisation is interpreted as a stockwork emplaced in the hanging wall of the massive sulphide by low angle thrust faults.

Cupriferous sulphide stockwork zones (fissural mineralisation), consisting of veinlet sulphides cutting footwall shales, quartzites and acid volcanics, underlie the massive sulphide lens over part of its area.

Tin-rich ore is spatially associated with the copper ore, principally in the massive sulphide material and Rubané. Massive sulphide tin ore, also containing high copper values, is distributed throughout the copper mineralisation at Corvo defining a north-south trend. At the north end, near the edge of the massive sulphides, the Rubané contained high grades of tin and the underlying stockwork also contained some tin ore.

Zinc mineralisation develops laterally to the southeast of the copper and tin ore within the massive sulphides.

A geological section through Corvo and Graça is shown in Figure 7.6.

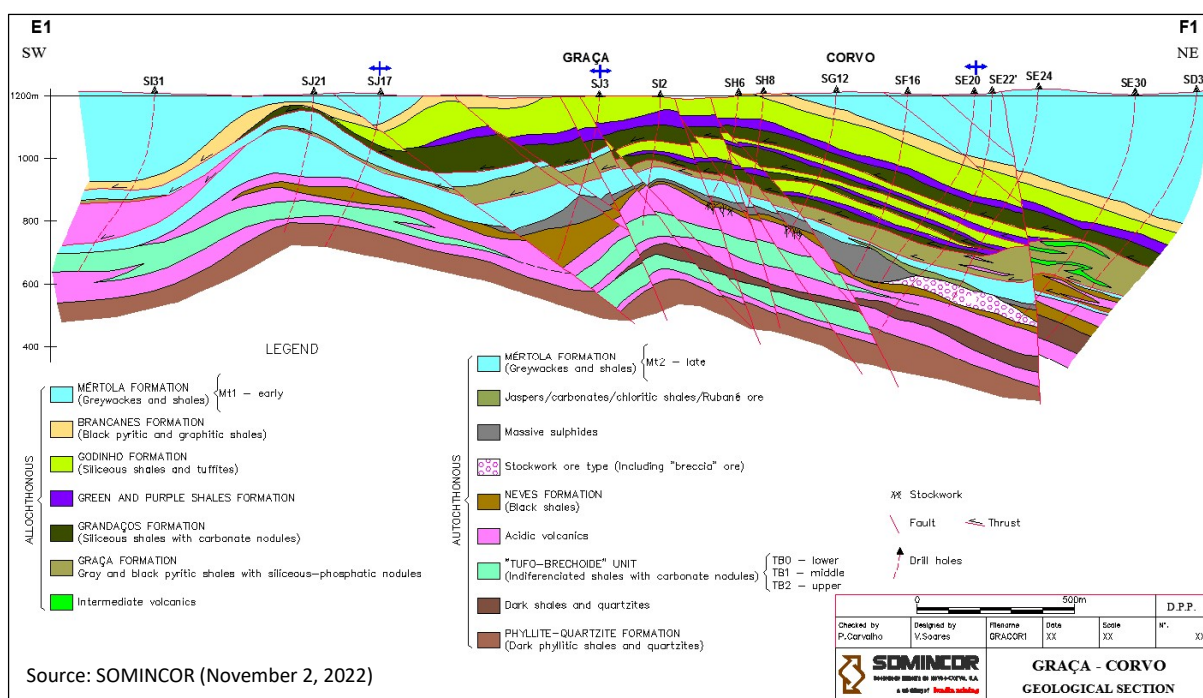

Figure 7.6: Geological Section of Corvo and Graça

## 7.5 Graça

The Graça orebody is up to 80m thick, extends for 700m along strike, 500m down dip and ranges in depth below surface from 230-450m. The orebody is linked to Corvo by a bridge of thin continuous sulphide mineralisation. As with Corvo, much of the copper ore occurs as a basal layer overlain by barren pyrite in which there are also intercalations of copper ore. Most of the copper mineralisation

within the Graça orebody has been mined out with the exception of a small extension to the southeast that lies on the southern flank of the anticline and dips to the south at 10-70°.

A significant massive zinc zone has been exploited in Graça SW.

Massive sulphide tin ore occurs as a trend through the copper ore from northeast to southwest, similar to Corvo. There is no significant development of Rubané, although stockwork copper ore is being exploited in the southeast section of the orebody and extensions to this mineralisation are being investigated. In the massive sulphide there are strong lateral metal zoning patterns and zinc occurs preferentially in the southwest limit of Graça.

## **7.6 Neves**

The Neves orebody consists of two lenses of mineralisation which dip north at 0-35° and are joined by a thin bridge. The maximum true thickness is 55m with a strike length of 1,200m extending 700m down dip. The southern lens, Neves South, contains mostly zinc mineralisation with significant lead, silver and copper grades and minor barren pyrite underlain by copper ore which is locally tin-bearing. Zinc mineralisation tends to be very fine grained (<25microns) and does contain deleterious elements such as As, Sb and Hg.

In contrast, Neves North is copper-rich and occurs mainly as a basal massive sulphide and as stockwork in the underlying shale and volcanic rocks. The stockwork is well developed and extends well beyond the limits of the massive sulphide lens.

A geological section through Neves into Lombador is shown in Figure 7.7.

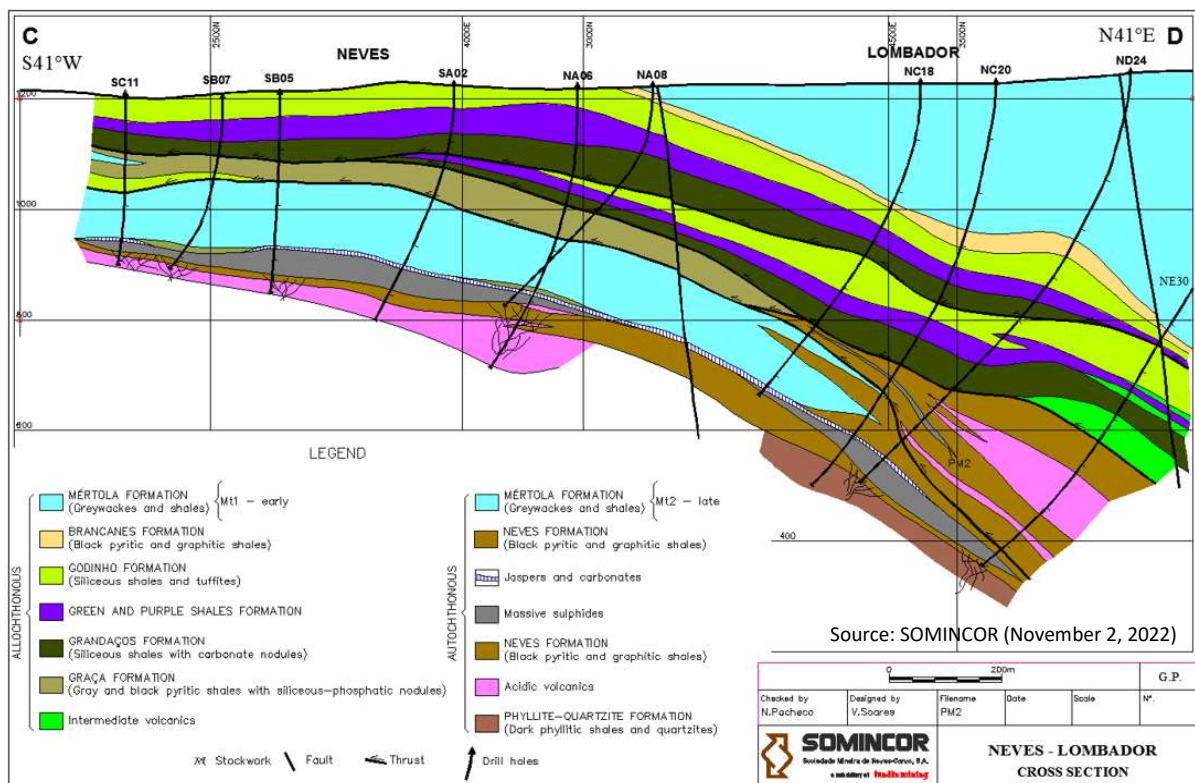

**Figure 7.7: Geological Cross-Section of Neves and Lombador**

## 7.7 Zambujal

The Zambujal orebody is located to the south of the Corvo orebody and is connected to Lower Corvo by a bridge of mineralisation. The upper part of the orebody is found at 380m below surface, has an average thickness of 55m and includes massive zinc and copper zones and a significant underlying copper stockwork. The mineralisation is found on two limbs of the anticline and are considered as Zambujal SW and Zambujal NE (based on the fold limbs). Zambujal SW limb dips at 15° to the southwest and extends for 250m down dip. Zambujal NE limb dips at 20-30° to the northeast. The massive sulphides extend for up to 290m down dip while the underlying stockwork extends further (up to 360m down dip) into Zambujal East with isolated zones identified beyond this. Areas of Zambujal are known to contain elevated levels of deleterious elements such as As, Sb and Hg which require blending with other ores prior to processing.

A geological section through Zambujal is shown in Figure 7.8.



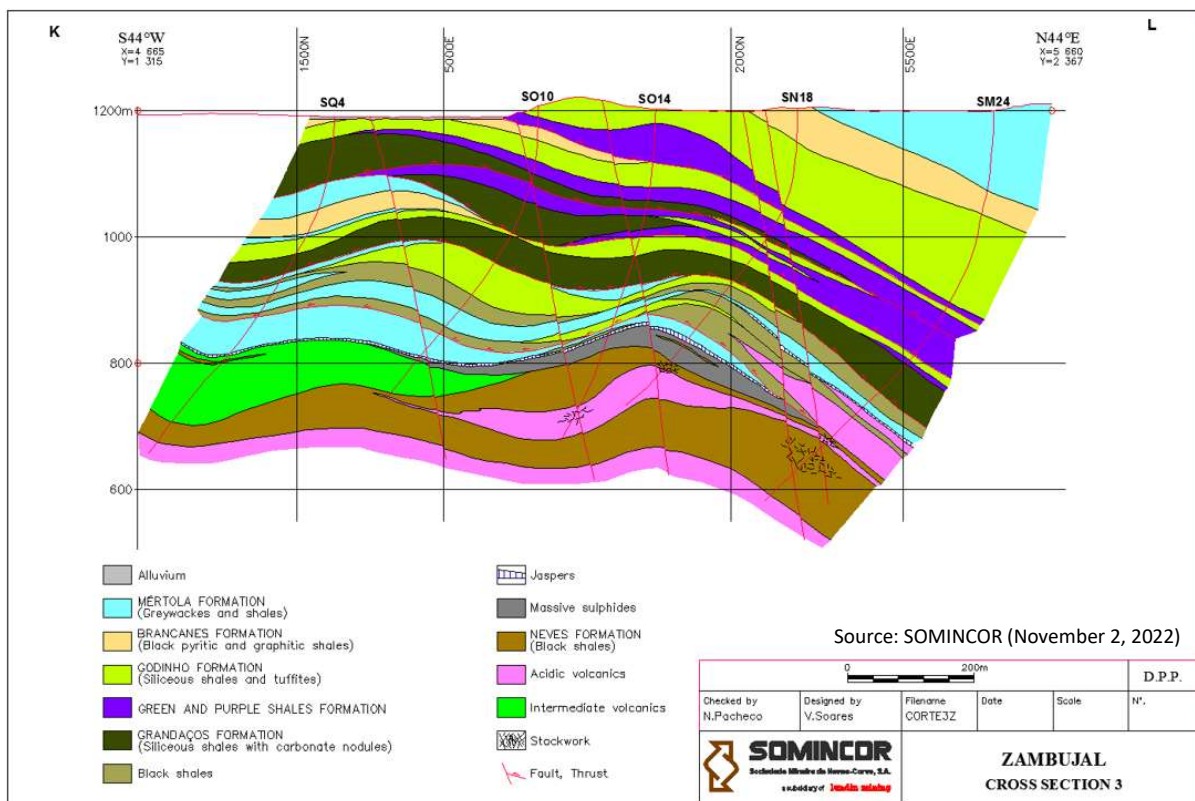

**Figure 7.8: Geological Section of Zambujal**

## 7.8 Lombador

The Lombador orebody is the largest of the five massive sulphide zones at Neves-Corvo and is situated on the north-eastern flank of the anticline, to the north of Neves and Corvo orbodies. It is located at a depth of 400m at its western end and extends down to depths of 1,200m below surface. It dips to the northeast at approximately 35° but steepens at depth and has a shallow plunge to the northwest. The sulphide lens has dimensions of up to 70m in thickness and extends for approximately 1,400m down dip and at least 1,600m along strike and is open to the north. Lombador is connected by a bridge of mineralisation to the massive sulphide lenses of Corvo and Neves.

The Lombador orebody is affected by at least three tectonic events that deformed the Neves-Corvo region resulting in the following:

- A system of north-south orientated sub-vertical faults;
- Low angle thrust shears that resulted in duplications of the stratigraphy; and
- Normal left-lateral sub-vertical faults oriented N30°W and N30°E, which dislocate all the sequences, including the massive sulphides.

The north-south and the sub-vertical faults displace the massive sulphide lenses in places by up to tens of metres. A significant north-south fault separates the massive sulphide of Lombador South from Lombador East.

The massive sulphide lenses are bounded on both the footwall and the hanging-wall by thrusts, and additional thrusts occur further into the hanging-wall lithologies. In places, the thrusts within the mineralisation have resulted in duplications that have further increased the thickness of the sulphide mineralisation. However, the thrusting can result in geotechnical problems when thick zones of broken rock occur in the hanging-wall of stopes or development drives.

Mineralisation includes massive sulphides containing zinc rich mineralisation (MZ and 5Z) and copper-rich (MC). A broad continuous zone of copper-rich stringer/stockwork ores (FC type) extends for some 400m at the bottom of the MC mineralisation. Within the massive sulphide lens are several zones of higher-grade zinc, copper and copper plus zinc mineralisation. These have been sub-divided into Lombador East and Lombador South zinc zones (with associated copper-rich stockwork zones) and the Lombador North area. Lombador South and East include two high-grade zinc and/or copper zones, both of which are enclosed within the much larger massive sulphide lenses. The two deposits are separated by approximately 150m of barren pyrite. A copper-rich stockwork zone in the footwall to the massive sulphide lens trends across this barren zone to connect the two deposits. This copper zone extends outside of the zinc mineralisation laterally, into the area between Lombador East and South. The Lombador massive sulphides are overlain by predominantly felsic volcanic rocks.

Recent exploration drilling to the north of Lombador has identified a significant copper stockwork at a depth of 1,360m below surface and along strike of the existing massive zinc mineralisation.

A geological section through Neves and Lombador deposits is shown in Figure 7.9.

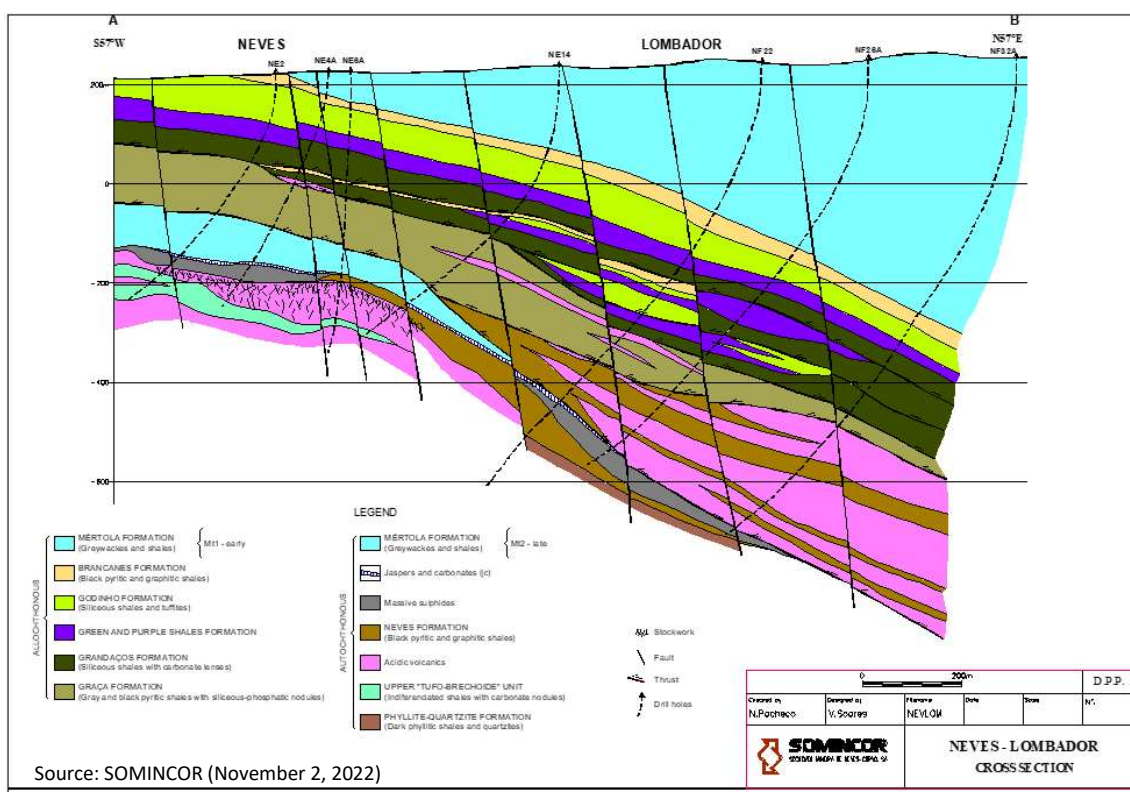

Figure 7.9: Geological Cross-Section of Neves and Lombador

## 7.9 Monte Branco

The Monte Branco orebody was discovered in 2011 from surface exploration drilling. The deposit is located approximately 1.2km south of Semblana and to the west of the Cerro do Lobo tailings storage facility. The deposit consists of six discontinuous lenses that have been strongly affected by tectonic shearing. Monte Branco covers approximately 250m by 200m in area and is found at depths of between 540m and 700m below surface. The deposit contains copper sulphide mineralisation and includes both massive and stockwork types.

## 7.10 Semblana

The Semblana orebody is almost flat and has a gentle dip (15-20°) to the north and is located at a depth of 790m below surface. Drilling from surface has intersected mainly copper stockwork (FC), although several small zones of massive copper (MC) in lenses have also been identified. The hangingwall stratigraphy is identical to that at Corvo and Zambujal, but rhyolites are seen exclusively in the footwall at Semblana, with widths varying from a few metres to tens of metres. Mineralisation in the rhyolites is occasionally observed but is not considered economic. Tin is sometimes present both in the stockwork and the massive mineralisation but is confined to the northern part of the orebody. Discrete pods of zinc mineralisation have been identified in the south. No continuous bridge of significant mineralisation connecting Zambujal and Semblana has been identified from recent exploration drilling, although some stockwork mineralisation does extend to the northeast from Zambujal. A geological section through Zambujal and Semblana is shown in Figure 7.10.

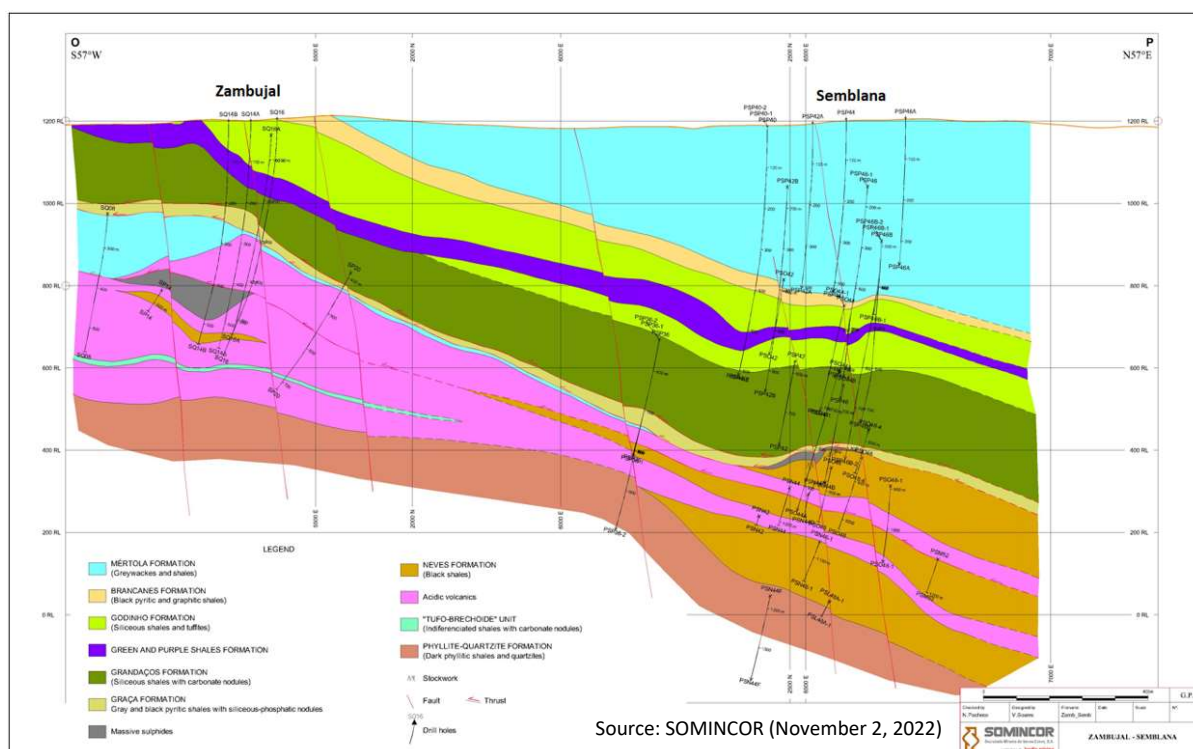
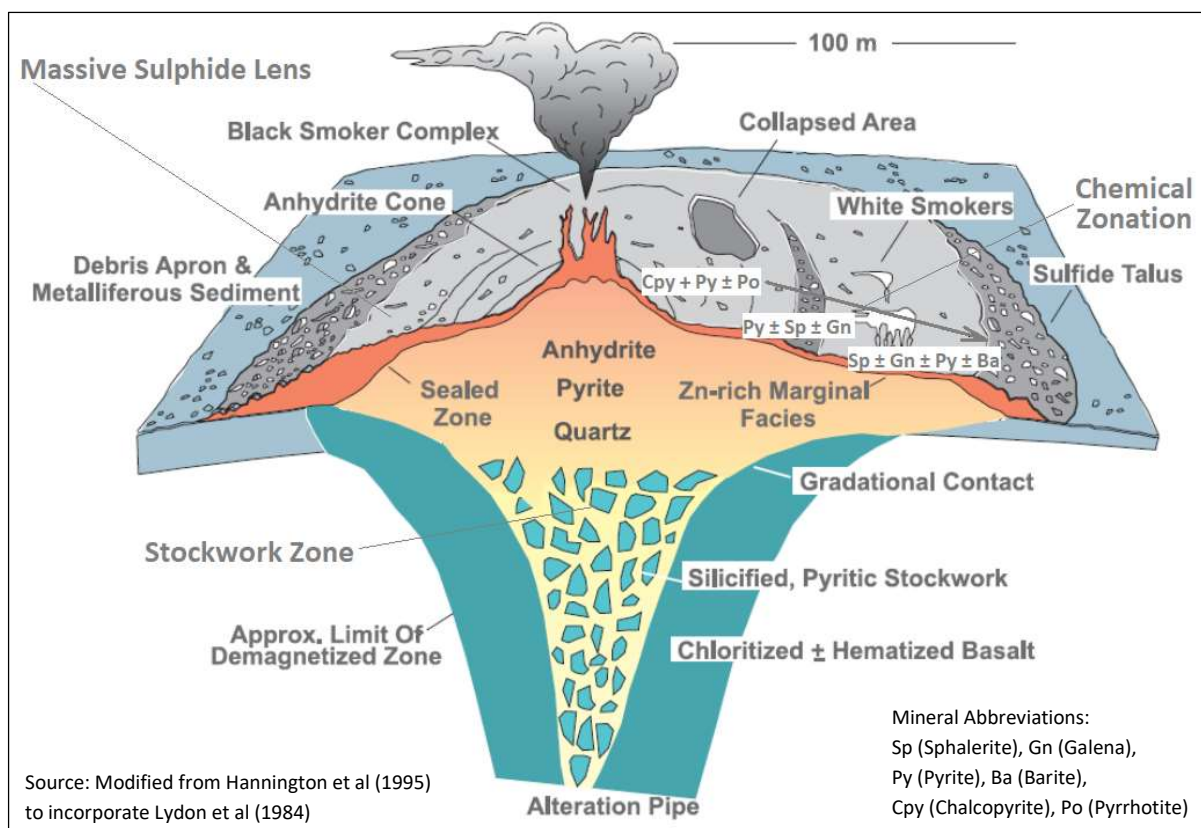

Figure 7.10: Geological Section of Zambujal and Semblana

## 8 DEPOSIT TYPES

The deposits of the Neves-Corvo Mine are classified as volcanogenic massive sulphides (VMS). They are also known as volcanic-associated, volcanic-hosted, and volcano-sedimentary-hosted massive sulphide deposits. The deposits typically occur as lenses of polymetallic massive sulphides that formed at or near the seafloor in submarine volcanic environments, and are classified according to base metal content, gold content or host-rock lithology.

VMS deposits are found in submarine volcanic terranes that range in age from 3.4Ga to actively forming deposits in modern seafloor environments. They formed from accumulations of focussed discharges of hot metal-enriched fluids associated with seafloor hydrothermal convection, typically in extensional tectonic settings of active submarine volcanism, including rift spreading centres and island arc subduction zones. The massive sulphide lenses are commonly underlain by sulphide-silicate stockwork vein systems, although the stockwork systems may also extend into the hanging-wall strata above the massive sulphide lenses. The immediate host rocks can be either volcanic or sedimentary. The deposits are overlain by a repetition of volcanic-sedimentary and flysch units. A genetic model of ore formation for VMS deposits is shown in Figure 8.1.



**Figure 8.1: Idealised VMS Deposit**

Some of the world's most economically important VMS deposits are hosted by bimodal felsic dominated siliciclastic districts and primitive bimodal mafic volcanic dominated districts. Most, but not all, VMS districts occur within large volcanic edifices, calderas and crustal structures. Large

deposits, more than 50 or 100 million tonnes, are uncommon. Some large deposits are associated with a major long-lived crustal structure (Kidd Creek) or with thick successions of volcanoclastic rocks (Bathurst) or occur in more stable rifted continental margin settings (IPB). The large deposits tend to be associated with large, diffuse low temperature alteration systems (Gibson et al., 2007).

Deposits associated with mafic dominated terranes tend to be copper and copper-zinc endowed. Large deposits such as Kidd Creek, Flin Flon and Horne have exceptional endowments of copper, gold and/or value-added metals (e.g. indium and tin at Kidd Creek). Continental margin deposits with felsic volcanoclastic-sedimentary host rocks have a higher lead-zinc endowment (e.g. Zinkgruvan, Bergslagen) or lead-gold-silver concentrations (e.g. Roseberry, Tasmania; Petiknas, Sweden; Eskay Creek, Canada; Greens Creek, Alaska). Neves-Corvo is exceptional due its large copper-tin endowment. Strongly metamorphosed deposits commonly found in Archean or Proterozoic terranes tend to have coarser grained sulphides and consequently metal recovery is commonly better than for finely crystalline sulphides in some of the less metamorphosed districts. Recrystallisation can also complicate recoveries with metal intergrowth and substitution of deleterious metals, e.g. selenium and thallium, but can also thermally and mechanically “purify” deposits by reducing the contents of metals as mercury, arsenic and antimony (Gibson et al., 2007).

The long history of exploration within the IPB means that almost all outcropping and near surface massive sulphide deposits have been found and exploited. Current exploration within the IPB therefore focusses on the search for deeply buried massive sulphide deposits. Geophysical techniques including airborne magnetics, residual ground gravity survey, airborne gravity survey, ground electromagnetic (EM) survey, borehole electromagnetic survey and 2D or 3D seismic survey have been successful in discovering new massive sulphide deposits (e.g Semblana at Neves-Corvo, Magdalena at Aguas Teñidas and Elvira at Sotiel). The discovery of massive sulphides within complex tectonic situations (Neves-Corvo, Migollas, Concepción) highlights the importance of good structural analyses combined with good lithostratigraphic interpretations of the host rock facies. Geophysical anomalies in areas underlain by PQ Group cannot be eliminated from further exploration. Similarly, exploration beyond traditional zones of outcropping VSC has shown that areas underlain by the Flysch Group (Masa Valverde) or Tertiary cover (Los Frailes, Lagoa Salgada, Las Cruces) need also be considered for exploration. Leistel et al. (1998) identify further geological criteria for incorporation in exploration models:

- Determination of “fertile” regional volcano-sedimentary sequences for which no evident metal-potential data are available;
- Characterisation of hydrothermal alteration zones related to the massive sulphides, revealed through geochemical exploration (they extend for several kilometres, are marked by geochemical anomalies and the presence of alteration minerals, and show enrichment in major and trace metal elements (Pb, Zn, Cu, Co, Sb, As, Sn, Bi, Ag, Se, Tl, Ba, strong leaching of Na, Ca and immobile elements depletion; the most abundant alteration minerals are chlorite and sericite);

- Selection of “fertile” paleostructures, at least within the IPB (aided by searching for regional alignments of sulphide occurrences and by noting syn-depositional faults reactivated during the Variscan orogeny);
- Discrimination of doubtful mineralised occurrences, geochemical soil anomalies or gossans through lead isotopic analysis (the massive sulphide deposits and their feeder stockworks reveal a very homogenous lead isotopic signature throughout the IPB, which clearly distinguishes them from later vein mineralisation);
- Recognition of “fertile” gossans developed from massive sulphide deposits (distinguished from other types of barren ferruginous concretion by their characteristic Cu-Pb-Ag-Sb-Bi-Au-Sn-Ba geochemical signature);
- Identification of sulphide veinlets discovered in the field or intersected by drilling (aided by the fact that bismuth and cobalt minerals are specific to the stringer zones and interaction zones underlying the massive sulphide orebodies in the IPB);
- Evaluation of the proximity to underlying cupriferous enrichment in massive sulphide orebodies;
- Recognition of two types of gold-enriched facies both at regional and orebody scales (early and proximal Au-Co, and late and/or distal Au-Zn-Ag).

## 9 EXPLORATION

Exploration surrounding the Neves-Corvo Mine has focused on the search for further blind-type massive sulphide deposits and extensions of existing deposits.

The discovery of the Semblana deposit in 2010 was an important milestone in the history of exploration at Neves-Corvo and marked the first discovery of a new deposit since 1988. The discovery (located at a depth of 790m below surface) resulted from the combination of geophysical anomalies and geological interpretation beyond the northeast limbs of the Zambujal and Corvo orebodies. Surface drillhole PSO48 confirmed the presence of mineralisation by intersecting massive sulphides. Borehole electromagnetic (BHEM) surveying was performed in the drillhole, resulting in the identification of a strong off-hole conductor, thereby confirming the source of the geophysical anomaly as concentrated sulphide mineralisation. Follow up drilling from 2010-2013 resulted in a current Mineral Resource estimate for the Semblana deposit.

Following the discovery of Semblana, the Monte Branco deposit was discovered in 2011 when discovery drillhole SCA26 intercepted a 32.5m thick section of strong stockwork type copper sulphides grading 2.2% Cu and including a higher grade interval of 11.0m grading at 3.9% Cu (LMC press release dated December 15, 2011). The deposit is located approximately 1.2km to the south of Semblana and just west of the Cerro do Lobo TSF. The deposit is located at depths of between 540m and 700m below surface.

The discoveries of Semblana and Monte Branco provide clear evidence that the immediate area surrounding Neves-Corvo remains underexplored and that the potential for new discoveries remains high. In addition, the discoveries highlighted the importance of integrating multiple exploration techniques including: airborne magnetics, residual ground gravity, airborne gravity, ground and downhole electromagnetic (EM), and 3D seismic to guide exploration drilling, coupled with a high level of understanding of the structural geology.

In 2011, a high-resolution 3D seismic survey was conducted by HiSeis Pty Ltd over a 21km<sup>2</sup> area surrounding the Neves-Corvo mine. The survey was highly effective in identifying the existing massive sulphide deposits of Lombador and Semblana, again, highlighting the importance of this exploration technique.

In 2017, a mineral inventory range analysis (MIRA) study was undertaken by LMC (and was updated in 2020). The aim of the MIRA was to provide a framework from which exploration targets could be identified and prioritised. Based on this, a significant increase in near mine and regional exploration was initiated by LMC as part of a five-year strategy (2017 – 2021) with the following objectives:

- Step 1: Re-assess the Semblana area and in particular the gap zone between Semblana and Zambujal/Corvo;
- Step 2: Near mine exploration focussing on areas that could be developed within 3 years; and
- Step 3: Exploration within the exploration concession area to identify new deposits.

The exploration areas are shown in Figure 9.1 and the targets and exploration techniques are shown in Figure 9.2.

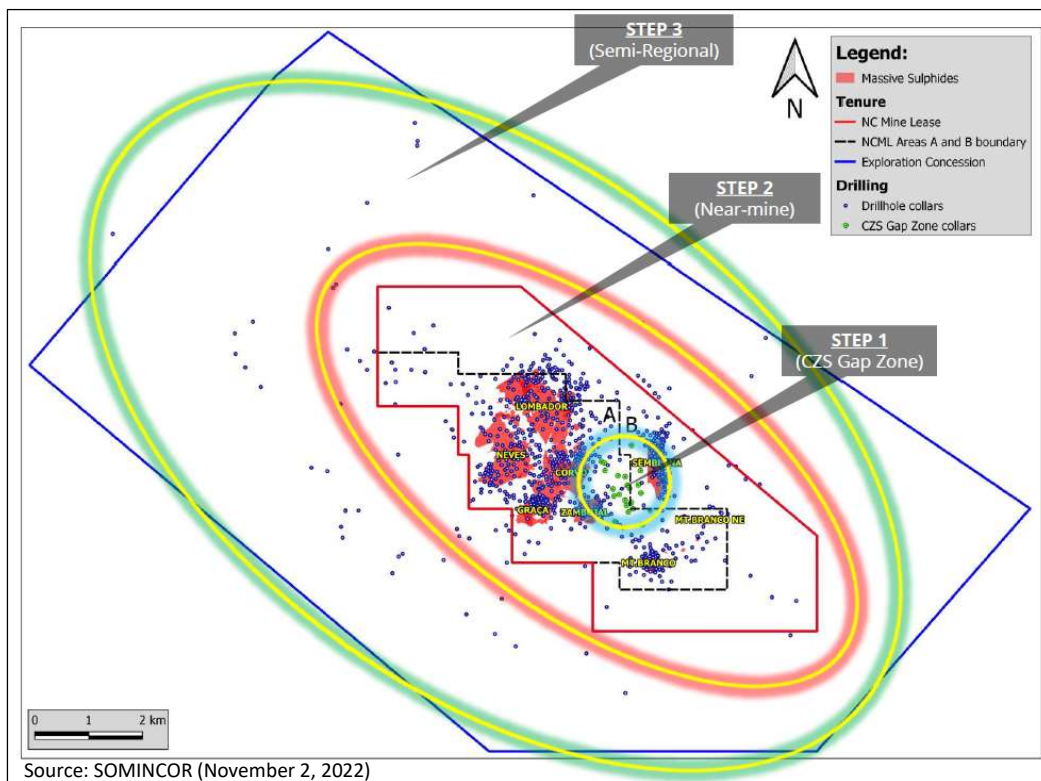

Figure 9.1: Exploration Areas in the 2017 Five-Year Strategy

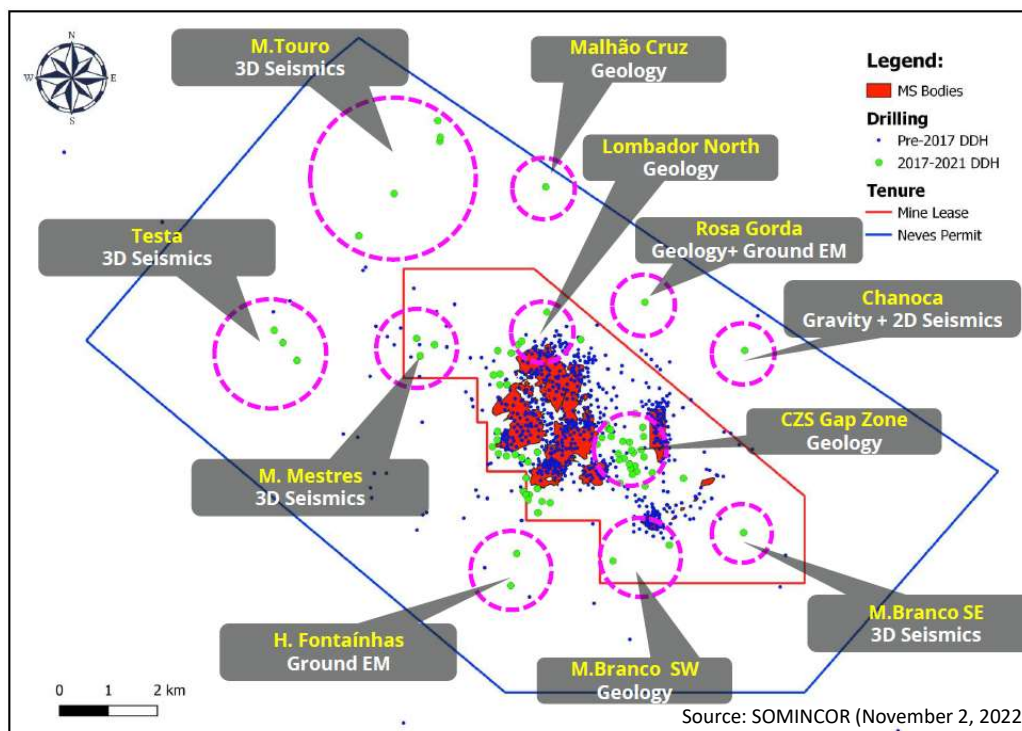

Figure 9.2: Exploration Areas in the 2017 Five-Year Strategy



A summary of the number of drillholes, meterage and budget completed in 2017 - 2021 is shown in Table 9.1.

<b>Table 9.1: Summary of Exploration Drilling in 2017 - 2021</b>			
<b>Year</b>	<b>Number of Drillholes</b>	<b>Meterage (m)</b>	<b>Budget (M USD)</b>
2017	22	18,853	3.88
2018	17	18,268	5.36
2019	24	26,855	7.08
2020	2	3,735	1.83
2021	34	17,247	3.56
Total	99	84,958	21.71

The most significant results from the 2017 -2021 exploration activities are detailed below:

- Zambujal/Semblana Gap Zone** - Drilling to the east of Zambujal identified additional copper stockwork zones extending up to 500m east of the Zambujal orebody, inside Area A of the Neves-Corvo Mining Concession. By the end of 2019, results indicated encouraging growth potential extending into Area B, towards and possibly connecting to Semblana. However, recent drilling conducted in 2022, suggests these zones do not appear to connect extensively or extend further towards Semblana. This indicates that no continuous bridge of mineralisation exists between Zambujal and Semblana;
- Semblana East (2022)** – Step out surface drilling east of Semblana intersected a stockwork zone within an area of low drill density. This area is considered to have potential to further expand the Mineral Resources of Semblana;
- Lombador North Stockwork** – Surface drilling to the north of Lombador (approximately 350m from the existing orebody) identified a deep but significant copper stockwork zone in drillhole NP14A-1 at a depth of 1,360m from surface and was confirmed by follow up drilling including hole NP28 in 2022. This indicates that the hydrothermal system in this area extends beyond the existing Lombador massive zinc orebody. The positive indication from BHEM surveying suggests that this zone of hydrothermal mineralisation could be expanded in this area. The locations of the drilling in Lombador North Stockwork are shown in Figure 9.3.

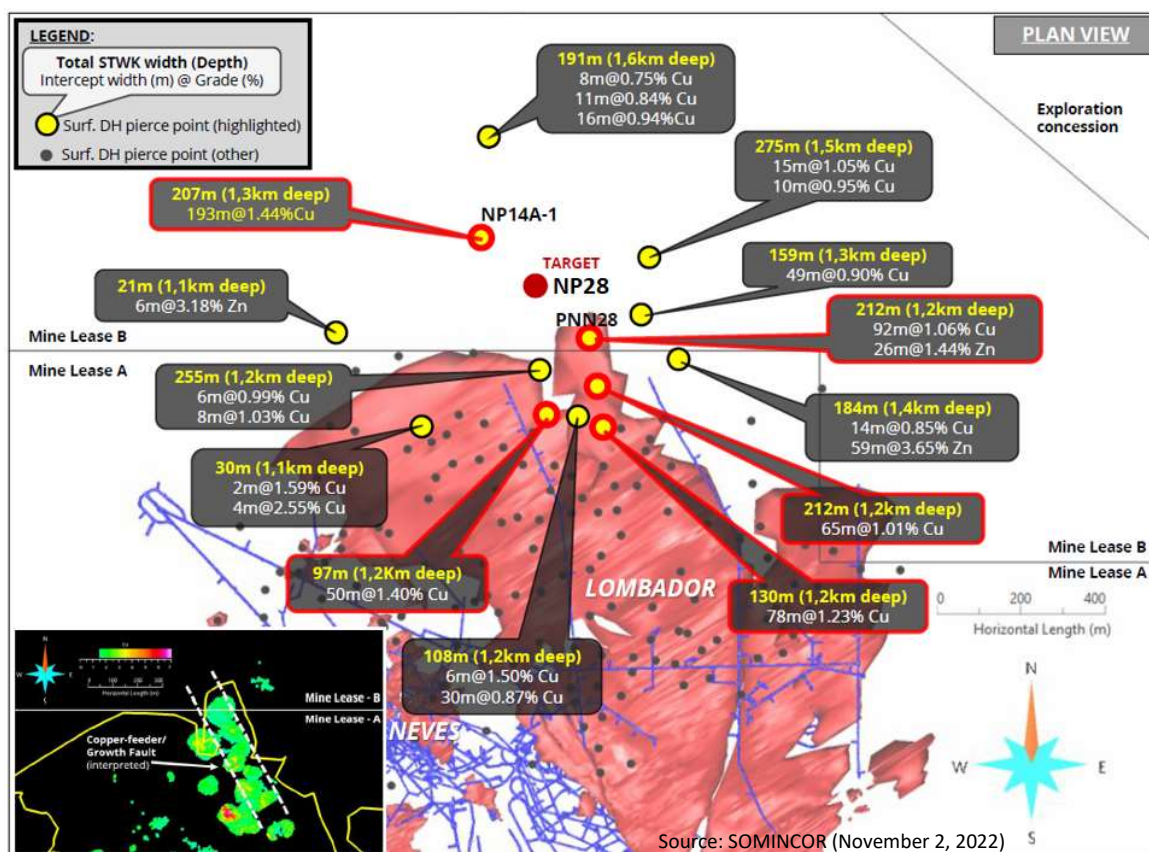

**Figure 9.3: Exploration Drilling in Lombador North Stockwork**

In 2022, a further five-year strategy for exploration (2022 - 2026) was implemented by SOMINCOR. The key targets for drilling in 2022 were as follows:

- Zambujal East Stockwork;
- Re-assessment of Monte Branco (including condemnation drilling to support positioning of a potential ramp design);
- Semblana East and North;
- Lombador North Stockwork;
- Cotovio and Guedelhinha areas (regional).

A summary of the number of drillholes, meterage and budget for 2022 is shown in Table 9.2.

Target	Number of Drillholes	Meterage (m)	Budget (M USD)
Zambujal East	8	8,800	1.92
Monte Branco	5	6,000	1.31
Semblana	8	9,600	2.10
Lombador North	3	5,100	1.12
Regional	2	3,100	0.68
<b>Total</b>	<b>26</b>	<b>32,600</b>	<b>7.14</b>

The locations of the drill targets are shown in Figure 9.4. Exploration was ongoing at the time of the site visit.

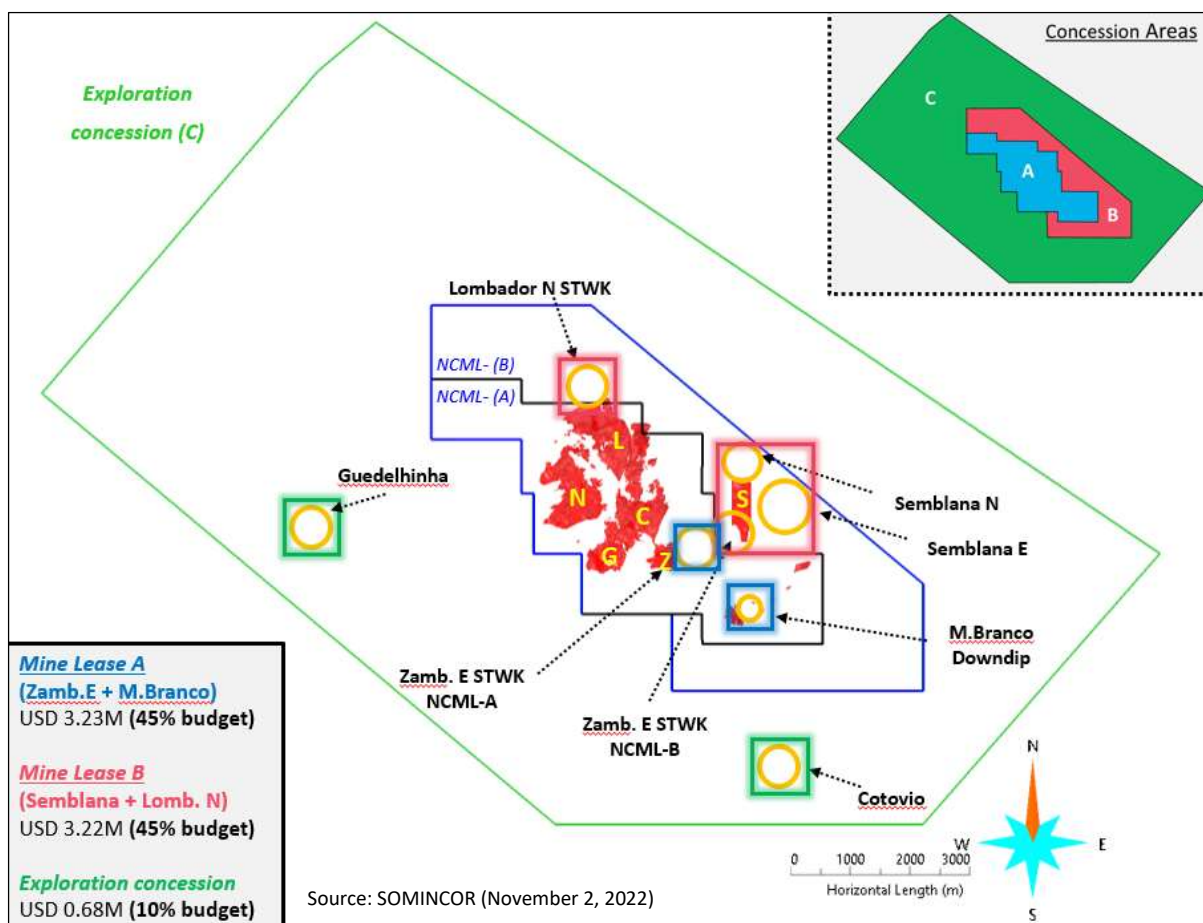

Figure 9.4: Locations of 2022 Drill Targets

## 10 DRILLING

Diamond core drilling is used at Neves-Corvo and includes surface and underground drilling methods. Underground drilling is a continuous activity and is used for exploration, upgrading of Mineral Resources, and defining mineralised contacts ahead of production. Surface drilling campaigns have been important over the years in stepping out beyond the limits of underground development to explore extensions to mineralisation. Underground drilling is used for infill and pre-production drilling and is typically undertaken on 35m or 17.5m spacing, whereas surface drilling is typically undertaken on 70m to 100m spacing or greater. Infill drill sections are orientated along profiles at 57° and are orientated perpendicular to the general strike of the deposits. Pre-production drilling is orientated to intersect the mineralisation as close to perpendicular to the deposit strike as can be achieved based on the underground development and is used to improve geological information for short term production plans.

### 10.1 Drilling History

From 1973 to 1984, as part of the joint venture between the Portuguese government (EDM) (51%), SMMPP (24.5%) and Conframines (24.5%), a total of 217 surface drillholes for 114,847m and 41 underground drillholes for 5,192m were completed during the discovery stage of the project. Surface drillholes were mainly located at Neves, Corvo and Graça and underground drilling was undertaken at Graça.

Rio Tinto became involved in the project in 1985 effectively forming a 49:51% joint venture with the Portuguese government (EDM). A total of 268 surface drillholes for 156,143m and 2,991 underground drillholes for 256,022m were completed during the feasibility and mine expansion phase. Surface drilling continued at Neves, Corvo and Graça and included expansion into Zambujal and Lombador. Underground drilling mainly focussed on Neves, Corvo and Graça. First production from the mine came from Upper Corvo and Graça on January 1, 1989.

On June 18, 2004, EuroZinc acquired a 100% interest in the project. During this phase a total of 40 surface drillholes for a total of 19,629m were completed and a total of 526 underground drillholes for a total of 42,626m were completed.

On October 31, 2006, LMC acquired EuroZinc. A total of 683 surface drillholes for a total of 521,156m and 6,065 underground drillholes for a total of 588,682m have been drilled by LMC up to June 30, 2022. Drilling by LMC also included the discovery of the Semblana and Monte Branco deposits and subsequent maiden Mineral Resource estimates on these in 2011 and 2013, respectively. Since 2016, LMC has significantly increased the amount of drilling at Neves-Corvo Mine with between 39,418m to 64,323m of underground drilling per year and 17,247m to 26,855m of surface exploration drilling per year during this period (excluding 2020).

A summary of the surface and underground drilling completed within the concessions is shown in Table 10.1 and Table 10.2, respectively. All drilling was by diamond core drilling.

**Table 10.1: Summary of Surface Drilling at Neves-Corvo Mine**

Company	Year	Neves		Corvo		Graça		Zambujal		Lombador		Monte Branco		Semblana		Regional		Total		
		Drill holes	Length (m)	Drill holes	Length (m)	Drill holes	Length (m)	Drill holes	Length (m)	Drill holes	Length (m)	Drill holes	Length (m)	Drill holes	Length (m)	Drill holes	Length (m)	Drill holes	Length (m)	
EDM, SMMPP and Conframines	1973 to 1984	48	21,104	82	49,358	48	20,486	13	7,712	2	1,775	7	4,069	-	-	17	10,345	217	114,847	
EDM and Rio Tinto	1985 to 2003	55	23,915	31	14,931	38	16,092	31	17,529	65	42,537	2	1,377	-	-	46	39,764	268	156,143	
EuroZinc	2004 to 2006	20	7,224	2	705	6	2,610	-	-	11	8,276	-	-	-	-	1	814	40	19,629	
LMC	2007	-	-	3	1,341	-	-	3	1,514	38	25,862	-	-	-	-	4	1,648	48	30,365	
	2008	15	6,250	3	3,410	-	-	1	477	42	27,265	-	-	-	-	2	2,285	63	39,688	
	2009	10	5,249	3	2,869	-	-	-	-	64	34,476	-	-	-	-	8	3,967	85	46,561	
	2010	12	6,572	4	3,673	-	-	-	-	36	28,012	-	-	26	19,599	3	1,720	81	59,575	
	2011	-	-	-	-	-	-	-	-	9	6,636	11	9,809	73	62,105	4	2,467	97	81,017	
	2012	-	-	1	1,387	-	-	-	-	-	-	54	46,608	53	46,436	7	2,044	115	96,476	
	2013	-	-	4	3,858	-	-	1	966	-	-	43	37,330	9	6,879	2	592	59	49,625	
	2014	-	-	-	-	-	-	-	-	-	-	9	5,939	-	-	1	1,515	10	7,453	
	2015	-	-	-	-	-	-	-	-	-	-	-	-	-	-	-	-	-	-	
	2016	-	-	-	-	-	-	-	-	-	-	-	-	-	-	-	-	-	-	
	2017	-	-	-	-	-	-	-	9	9,523	4	1,757	-	-	5	4,438	4	3,136	22	18,853
	2018	-	-	-	-	-	2	1,449	-	-	7	6,230	3	4,488	-	-	5	6,101	17	18,268
	2019	-	-	-	-	-	-	-	10	10,176	-	-	-	-	3	2,317	11	14,362	24	26,855
2020	-	-	-	-	-	-	-	-	-	-	-	-	-	-	-	2	3,735	2	3,735	
2021	16	7,301	4	3,097	14	6,849	-	-	-	-	-	-	-	-	-	-	-	34	17,247	
2022	-	-	-	-	-	-	-	1	920	-	-	9	7,111	11	11,712	5	5,695	26	25,438	
<b>Total</b>		<b>176</b>	<b>77,614</b>	<b>137</b>	<b>84,630</b>	<b>108</b>	<b>47,486</b>	<b>69</b>	<b>48,817</b>	<b>278</b>	<b>182,826</b>	<b>138</b>	<b>116,729</b>	<b>180</b>	<b>153,486</b>	<b>122</b>	<b>100,190</b>	<b>1,208</b>	<b>811,776</b>	

Note: Reported numbers do not include geotechnical drilling

**Table 10.2: Summary of Underground Drilling at Neves-Corvo Mine**

Company	Year	Neves		Corvo		Graça		Zambujal		Lombador		Monte Branco		Semblana		Regional		Total	
		Drill holes	Length (m)	Drill holes	Length (m)	Drill holes	Length (m)	Drill holes	Length (m)	Drill holes	Length (m)	Drill holes	Length (m)	Drill holes	Length (m)	Drill holes	Length (m)	Drill holes	Length (m)
EDM, SMMPP and Conframines	1982 to 1984	-	-	41	5,192	-	-	-	-	-	-	-	-	-	-	-	-	41	5,192
EDM and Rio Tinto	1985 to 2003	1,124	95,914	1,419	120,120	420	35,552	28	4,435	-	-	-	-	-	-	-	-	2,991	256,022
EuroZinc	2004 to 2006	114	5,635	219	11,006	27	2,552	81	13,213	85	10,221	-	-	-	-	-	-	526	42,626
LMC	2007	57	4,896	56	2,524	20	2,470	24	2,401	14	2,046	-	-	-	-	-	-	171	14,337
	2008	101	9,285	24	365	6	211	51	4,612	20	3,076	-	-	-	-	-	-	202	17,549
	2009	61	5,085	12	244	-	-	31	3,359	55	7,552	-	-	-	-	-	-	159	16,239
	2010	144	3,913	19	1,080	-	-	17	1,702	43	10,852	-	-	-	-	-	-	223	17,548
	2011	148	9,911	25	2,071	-	-	56	5,010	58	19,646	-	-	-	-	-	-	287	36,639
	2012	96	8,297	38	2,558	-	-	16	1,163	125	24,421	-	-	-	-	-	-	275	36,439
	2013	48	6,927	25	1,600	1	69	9	697	194	38,663	-	-	-	-	-	-	277	47,956
	2014	26	1,199	92	13,729	-	-	8	140	63	18,740	-	-	-	-	-	-	189	33,808
	2015	75	5,791	49	8,161	-	-	209	12,680	79	24,255	-	-	-	-	-	-	412	50,887
	2016	166	12,469	92	4,636	3	150	56	2,902	46	2,854	-	-	-	-	-	-	363	23,010
	2017	276	13,532	68	6,685	-	-	140	10,063	84	9,138	-	-	-	-	-	-	568	39,418
	2018	321	21,477	72	7,545	-	-	34	11,764	86	13,566	-	-	-	-	-	-	513	54,351
	2019	285	30,545	31	1,565	-	-	110	12,959	71	19,255	-	-	-	-	-	-	497	64,323
2020	203	10,362	62	4,196	-	-	86	9,462	63	12,045	-	-	-	-	-	-	414	36,065	
2021	277	10,768	247	10,833	1	105	94	8,508	74	9,753	-	-	-	-	-	-	693	39,966	
2022	231	14,281	198	13,343	14	383	91	12,155	288	19,985	-	-	-	-	-	-	822	60,147	
<b>Total</b>		<b>3,753</b>	<b>270,287</b>	<b>2,789</b>	<b>217,453</b>	<b>492</b>	<b>41,492</b>	<b>1,141</b>	<b>117,222</b>	<b>1,448</b>	<b>246,067</b>	-	-	-	-	-	-	<b>9,623</b>	<b>892,522</b>

Note: Reported numbers do not include geotechnical drilling

## **10.2 Diamond Core Drilling**

Underground drilling is undertaken by Drillcon (a Swedish contractor with a Portuguese subsidiary based in Braga) and Swick (a Western Australian contractor with a local office in Castro Verde). Surface drilling is undertaken by Hy-Tech Drilling (a Canadian contractor from Smithers, BC, with a local office in Castro Verde).

Underground drilling consists of evaluation and pre-production drillholes. Evaluation drillholes are used for exploration and upgrading of Mineral Resource classification and are carried out at a drill spacing of around 17.5m to 35m. Drilling is undertaken by Drillcon using three skid mounted diamond drill rigs; however, some additional evaluation drilling is also provided by Swick when required. Pre-production drilling is carried out to better define mineralised contacts ahead of production. The drill spacing is irregular, however, can be as little as 7.5m within the stockwork zones. The length of pre-production drillholes is typically 15 to 20m but can be up to 100m. The majority (around 70%) of pre-production drilling is conducted in the stockwork zones with less drilling required to define the contacts of the massive mineralisation. Pre-production drilling is undertaken by Swick using nine Atlas Copco jumbo mounted exploration rigs. Jumbo rigs are used to reduce set up time at the drill sites compared to skid mounted rigs.

Surface drilling is undertaken by Hy-Tech Drilling using Tech-5000 compact hydraulic diamond drill rigs capable of drilling depths of up to 2,000m.

## **10.3 Core Diameter**

Underground drill core can be either NQ or BQ depending on the drilling contractor. Surface drilling normally intersects the mineralised zones with NQ size core. Typically, surface holes begin with HQ and reduce to NQ before intersecting mineralisation. This provides the opportunity to reduce rod size and pass problematic zones of poor ground. Occasionally both surface and underground holes are reduced to BQ to pass problematic zones within the sulphides.

## **10.4 Core Recovery**

Sulphide mineralisation at Neves-Corvo is generally competent and core recoveries of greater than 90% are achieved during drilling. No correlation between metal grades and core recovery has been observed. The authors of this report consider there are no material issues resulting from drill core recovery and that the core recoveries attained are acceptable for use in Mineral Resource estimation.

## **10.5 Surveying**

Drillhole collar locations are surveyed by the mine survey team using Leica system equipment. Underground surveying is done using Leica TCR705 or TCR805 instruments. Surface holes are spotted with hand-held GPS units and then surveyed by the mine using Leica TCR1205 instruments.

All drillholes are downhole surveyed on roughly 30m intervals. Prior to 2008, underground drillholes were surveyed using the Kodak Eastman Single Shot tool. Since 2008, underground drillholes have been surveyed with Reflex Ez-Trac equipment. Surface holes are surveyed with the Reflex Easy Shot system, both travelling in and out of the hole. The Devico directional drilling tool was used to guide surface drilled holes to targets and maintain an even grid spacing. For directional drilling, parts of the hole are surveyed independently by the Devico sub-contractors, providing an additional verification on the EZ Shot survey data. Since 2021, a SPT Gyromaster Tool has been used for long underground infill drillholes.

## 10.6 Drilling Extents

To date, drilling has defined the seven mineralised zones of: Neves, Corvo, Graça, Zambujal, Lombador, Monte Branco and Semblana with a combined total strike length of over 5,000m and to depths of up to 1,400m from surface. Neves, Corvo, Graça, Zambujal and Lombador are the most extensively drilled and includes underground and surface drilling. Monte Branco and Semblana are relatively new discoveries and have been drilled only from surface.

The location of the surface and underground drillholes within the concessions are shown in Figure 10.1 and Figure 10.2.

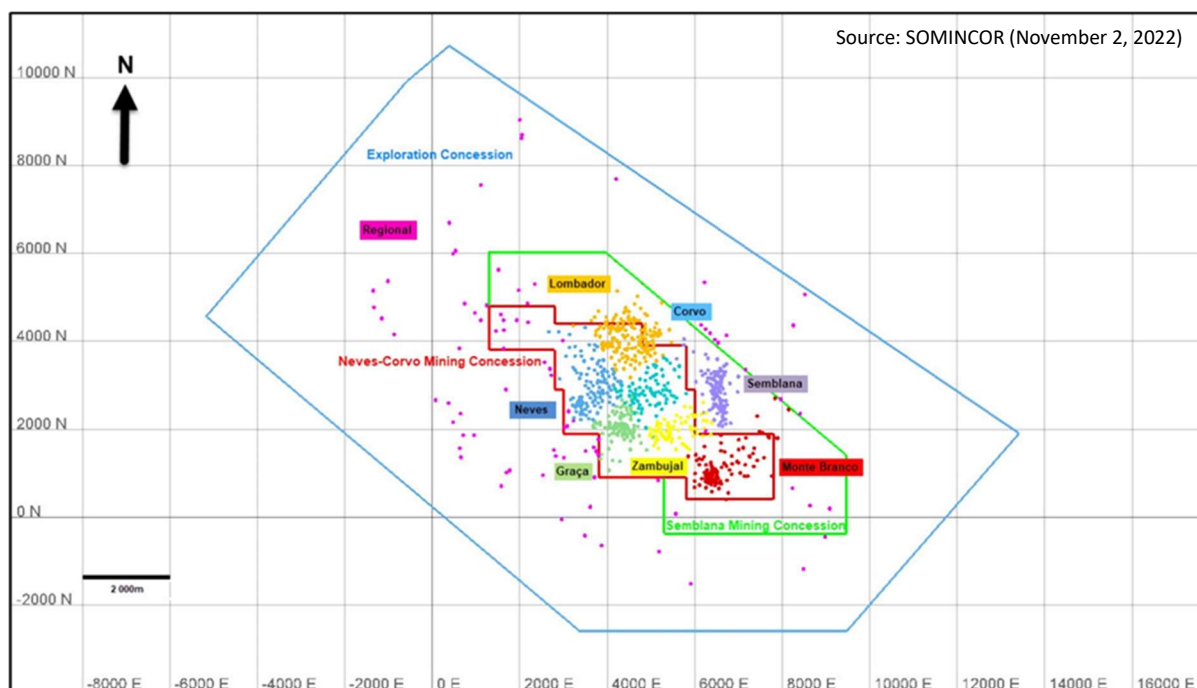
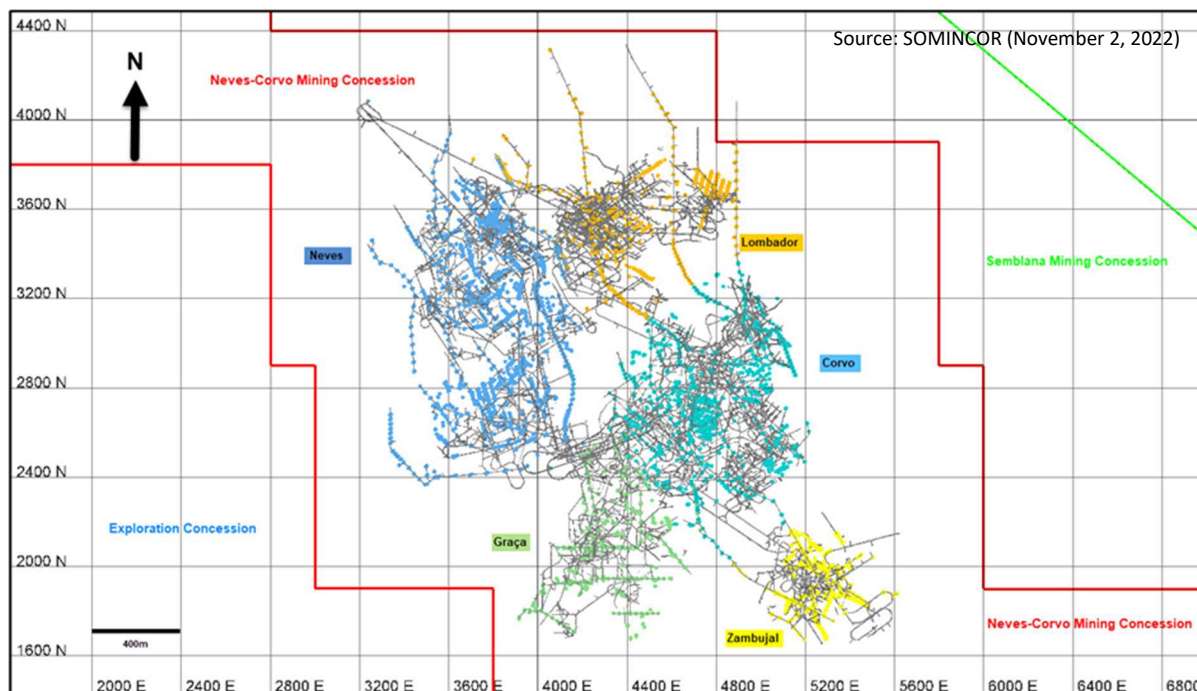

Figure 10.1: Location of Surface Drillhole Collars





**Figure 10.2: Location of Underground Drillhole Collars**

Relevant drill sections showing the geological interpretation of the Neves-Corvo deposits are contained in Section 7.3. A summary and interpretation of relevant results pertaining to recent exploration drilling is contained in Section 9.

### 10.7 Adequacy of Procedures

The authors consider the drilling and core sample collection at the Neves-Corvo Mine are undertaken by competent personnel using procedures that are consistent with industry best practices. The authors conclude that the samples are representative of the mineralisation and there is no evidence that the drilling or sample collection process has resulted in a bias that could materially impact the accuracy and reliability of the results.

## 11 SAMPLE PREPARATION, ANALYSES, AND SECURITY

Samples from face sampling and drill core are collected by SOMINCOR geological staff. Logging and sampling are undertaken at the on-site facility at Neves-Corvo or the exploration facility at Lombador. Sample cutting is undertaken at Lombador and sample preparation and analysis is undertaken at the Neves-Corvo analytical laboratory and is ISO 17025 accredited. Sample preparation of drill core from the Semblana exploration drilling in 2010 to 2013 was undertaken at ALS laboratories, Seville with assaying by ALS, Vancouver. A systematic Quality Assurance / Quality Control (QA/QC) system is used by SOMINCOR to monitor the accuracy and precision of assaying. The procedures used by SOMINCOR in the preparation and analysis of face samples and drill core samples are detailed in the following sections.

### 11.1 Face Sampling

Underground production faces are 5m x 5m in dimension and are sampled by chip sampling every second or third advance (i.e. sampled every 6 to 9m). Prior to 2020, different methods were used for face sampling depending on the style of mineralisation (i.e. massive or stockwork) as follows:

- Radial chip sampling was used in massive mineralisation and the face was divided into a 3 x 3 grid of radial samples, each of 1m diameter; and
- Channel chip sampling was carried out in stockwork mineralisation in which the face was divided into a 2 x 3 (horizontal x vertical) grid of vertically aligned channel samples, each of 1m in length.

Since 2020, only vertical channel chip sampling has been used to sample both the massive and stockwork mineralisation, using a 3 x 3 grid of vertical channel samples, each of 1m in length.

Access to the highest samples is attained using a truck mounted access lift with safety cradle. Samples consist of fragments of chips and mineral dust and are extracted using a chisel and hammer. The typical sample weight is 3kg to 5kg. The sample is deposited into a heavy-duty sample bag and labelled with the face ID and sample number, before being transported to the surface and dispatched to the sample preparation facility. Geological mapping of each face is undertaken using electronic tablets.

### 11.2 Core Sampling

Drill core is removed from the core barrel at the drill site and is placed into core boxes. Sample intervals are recorded on the core box. Core from underground drilling is then transported to the on-site logging facilities at the Neves-Corvo Mine, while core from surface drilling is transported to the exploration facility at Lombador, 4km north of the main mine site.

The drill core is wetted with water, photographed and core recovery and RQD measurements are taken for each sample of core. The drill core is geologically logged for colour, texture, alteration, structures and mineralisation using electronic tablets which are uploaded to an SQL database. A

geologist is responsible for determining and marking the intervals to be sampled, selecting them based on geology, mineralisation, alteration or structure. A summary of the lithology codes used for logging is shown in Table 11.1.

<b>Table 11.1: Logging Codes</b>	
<b>Description</b>	<b>Code</b>
Massive Copper	MC
Massive Tin	MT
Massive Zinc	MZ
Massive Lead	MP
Stockwork Copper	FC
Stockwork Tin	FT
Stockwork Zinc	FZ
Massive Copper and Zinc	5C (MCZ)
Massive Zinc and Lead	5Z (MZP)
Rubané Tin	RT
Rubané Zinc	RZ
Massive Pyrite	ME
Stockwork Pyrite	FE
Rubané Pyrite	RE

Sampling is undertaken from top to bottom of the drillhole. Historically, 1m sample intervals were used within the massive sulphide mineralisation while sample intervals of up to 2m were allowed within the stockwork mineralisation. However, from 2015, 1m sample intervals were adopted for all mineralisation types (to better reflect the variability associated with the stockwork mineralisation).

Drill core from underground pre-production drilling is sampled as whole core. Drill core from underground evaluation drilling and surface exploration drilling is sampled as half core. Splitting of the core is undertaken at the Lombador facility. Core samples selected for analysis by the geologist are split along the axis of the core using a diamond saw in such a way that two equal halves of core are produced. Prior to 1999, quarter core was sampled, and the remaining three quarters of the core were archived, however, this was deemed to be less representative, particularly in stockwork mineralisation. The locations of this drilling now correspond to areas which have since been mined out, therefore, any bias associated with this sampling approach is not considered significant to the current Mineral Resource estimate.

Samples are placed in a heavy-duty plastic sample bags with identifying sample tags and secured with zip ties before being dispatched for sample preparation. The remaining half drill core from evaluation and surface exploration drilling is returned to the core box for archive and storage. Photographs and pulp duplicate samples of pre-production drillholes are retained for archive.

### **11.3 Bulk Density Determination**

Density measurements are undertaken by SOMINCOR geological staff at the Lombador exploration facility. The methodology used is detailed in the following sections.

### **11.3.1 Methodology Prior to April 2017**

Density was measured using the water displacement method. Three density measuring stations consisting of a metal cylinder fixed to a stable base plate were used. At the top of the cylinder there was an opening connected to a plastic hose and a long metal frame was used to insert the cores into the cylinder. The following points detail the density measurement method:

- The core was placed on the scale plate and weighed;
- The metal cylinder was filled with water until it overflowed through the hose. The metal frame was inserted into the tube so that its volume of water was displaced;
- The core was placed on the frame and inserted into the cylinder;
- The displaced water was collected in a plastic container and weighed on the scale;
- The weights of the core and of the water were recorded, and the density of the core was measured using the following formula:

Measured Density (g / cm<sup>3</sup>) = (Weight of the core (kg) / Weight of the water (kg)).

### **11.3.2 Methodology After April 2017**

Density was measured using the hydrostatic weighing method. There is one density measuring station, which consists of a metal basket, a plastic bucket, an elevating metallic platform and one hydrostatic scale. The scale rests on top of the platform and the metal basket is hooked onto its base. The bucket is placed on the bottom of the platform and a system of pulleys is used for lifting and lowering. The following points detail the density measurement method:

- The plastic bucket is filled with water, placed on the bottom of the platform and lifted using the pulleys until the basket is partially immersed;
- The core is placed on scale and weighed;
- The core is placed inside the basket and weighed once again, while completely immersed;
- The weight of the core is recorded both times and its density is measured using the following formula:

Measured Density (g / cm<sup>3</sup>) = (Weight of the core (kg) / (Weight of the core (kg) – Weight of the Immersed core (kg))).

Prior to 2016, density measurements were undertaken on evaluation drill core samples. From 2016 to 2020 this was reduced for established areas such as Neves, Corvo, Graça and Zambujal where a significant database of density measurements already existed. Since 2020, no density measurements have been undertaken on underground drillholes. The authors recommend that density measurements for underground drillholes should now be recommenced.

A strong positive correlation exists between sulphur, iron and density. Using the density and assay databases, the geological department grouped the data by deposit and mineralisation type and

statistical correlation analyses were undertaken. Based on this, linear regression formulae were calculated (shown in Table 11.2) and were used for estimation of density in the Mineral Resource estimate.

<b>Table 11.2: Regression Formulae for Estimation of Density</b>		
<b>Deposit</b>	<b>Mineralisation Type</b>	<b>Regression Formula</b>
Corvo	MC, MT	Density = 0.022*S + 0.019*Fe + 2.783
	MCZ	Density = 0.029*S + 0.003*Fe + 3.116
	ME	Density = 0.019*S + 0.025*Fe + 2.658
	FC	Density = 0.027*S + 0.019*Fe + 2.572
	FT	Density = 0.037*S + 0.010*Fe + 2.785
	FE	Density = 0.024*S + 0.016*Fe + 2.650
	MZ, FZ	Density = 0.030*S + 0.006*Fe + 2.992
	MZP, MP	Density = 0.025*S + 0.007*Fe + 3.362
Graça	MC	Density = 0.024*S + 0.022*Fe + 2.597
	MCZ	Density = 0.037*S + 0.005*Fe + 2.698
	ME	Density = 0.024*S + 0.019*Fe + 2.680
	FC	Density = 0.027*S + 0.016*Fe + 2.596
	FE	Density = 0.022*S + 0.019*Fe + 2.630
	MZ	Density = 0.021*S + 0.011*Fe + 3.252
	MZP, MP	Density = 0.022*S + 0.003*Fe + 3.561
Lombador	MC	Density = 0.024*S + 0.020*Fe + 2.723
	MCZ	Density = 0.024*S + 0.013*Fe + 3.114
	ME	Density = 0.019*S + 0.024*Fe + 2.708
	FC	Density = 0.030*S + 0.014*Fe + 2.621
	FT, FE	Density = 0.024*S + 0.017*Fe + 2.656
	MZ	Density = 0.025*S + 0.019*Fe + 2.801
	MZP, MP	Density = 0.031*S + 0.011*Fe + 2.977
	FZ	Density = 0.029*S + 0.021*Fe + 2.590
Neves	MC	Density = 0.022*S + 0.020*Fe + 2.766
	MCZ	Density = 0.019*S + 0.014*Fe + 3.272
	ME	Density = 0.023*S + 0.024*Fe + 2.549
	FC	Density = 0.028*S + 0.018*Fe + 2.554
	FE	Density = 0.025*S + 0.017*Fe + 2.611
	MZ	Density = 0.023*S + 0.015*Fe + 2.970
	MZP	Density = 0.025*S + 0.009*Fe + 3.239
	MP	Density = 0.032*S + 0.009*Fe + 2.852
	FZ	Density = 0.031*S + 0.016*Fe + 2.592
Zambujal	MC	Density = 0.025*S + 0.016*Fe + 2.843
	MCZ	Density = 0.026*S + 0.003*Fe + 3.373
	ME	Density = 0.021*S + 0.019*Fe + 2.870
	FC	Density = 0.031*S + 0.015*Fe + 2.594
	FE	Density = 0.028*S + 0.014*Fe + 2.648
	MZ, FZ	Density = 0.027*S + 0.019*Fe + 2.697
	MZP, MP	Density = 0.023*S + 0.004*Fe + 3.508
Monte Branco	MC, MCZ, ME	Density = 0.011*S + 0.037*Fe + 2.535
	FC, FT, FE	Density = 0.026*S + 0.016*Fe + 2.610
	MZ, MZP, FZ	Density = 0.021*S + 0.035*Fe + 2.344

Notes:  
 1. Density in t/m<sup>3</sup>; S in %; Fe in %; and  
 2. Semblana density estimated into block model directly from drillhole data.

For Corvo, Graça, Lombador, Neves, Monte Branco and Zambujal, a density of 2.86 t/m<sup>3</sup> was used for all waste lithologies and was based on the average measured density for these rock types.

## **11.4 Sample Preparation**

Following logging and sampling, sample preparation of the face samples and drill core is undertaken at the Neves-Corvo laboratory located at the mine site. Sample preparation of drill core from the Semblana exploration drilling (2010 - 2013) was undertaken at the ALS laboratory in Seville. A description of the sample preparation procedures used by the Neves-Corvo laboratory and ALS (Seville) are given below.

### **11.4.1 Neves-Corvo Laboratory**

The Neves-Corvo sample preparation laboratory includes the following equipment:

- 2 jaw crushers;
- 2 disc mills with high capacity;
- 2 riffle splitter -16 slot; and
- 2 ovens for geology samples.

The sample preparation procedures include the following:

- Samples are received at the sample preparation laboratory located at the back of the mine site analytical laboratory;
- Samples are placed in metal trays and dried at 105°C;
- Jaw crushers are used to reduce the samples to <6.3mm. The crushers are calibrated weekly and are cleaned with compressed air between each sample;
- Crushed material is rolled to homogenize and passed through a 16-slot riffle splitter to produce a 770g sample. The coarse reject material is not retained;
- The sample is pulverized to <150 microns and the disc mills are cleaned with quartz sand and compressed air between each sample.
- Approximately 50g to 100g of the pulverized sample is placed in a cardboard envelope labelled with a bar code and sent for analysis.
- Reject pulp samples (50g to 100g) are stored in vacuum packed plastic sample bags and collected by the geology department for storage.

The laboratory department implemented a bar code system of sample tagging in 2008, which further protects against sample swapping.

### **11.4.2 ALS Seville (Semblana Exploration Samples)**

Half core from the Semblana exploration drilling (2010 - 2013) was sent from the Lombador exploration facility to the ALS laboratory in Seville for sample preparation from which a 150g pulp sample was derived for analysis. The remaining coarse reject was returned to the Lombador exploration facility from which a further duplicate sample was split.

## 11.5 Sample Analysis

Sample analyses is conducted at the Neves-Corvo analytical laboratory located at the mine site. Drill core from the Semblana exploration drilling (2010 - 2013) was sent to ALS, Vancouver for analysis (following sample preparation by ALS, Seville). Descriptions of the sample analysis procedures at the Neves-Corvo laboratory and ALS (Vancouver) are detailed below.

### 11.5.1 Neves-Corvo Laboratory

The Neves-Corvo analytical laboratory is accredited by the Instituto Português de Acreditação (IPAC) certificate 93/L.10-3, renewed every 4 years and submitted annually to quality audits by the same Institute, in addition to internal audits. The laboratory has been accredited for ISO NP EN 45001, updated in 2002 to ISO/IEC 17025. Currently the laboratory is accredited for 35 analytical methods and around 130 determinations. Of these methods, 13 are used for operational and commercial purposes and 22 are used for environmental controls. The laboratory is also responsible for sampling the concentrate leaving the mine by train and at the Setúbal port facility.

Laboratory activity is governed by written contracts with respect to the following:

- Number and frequency of samples to be delivered to the laboratory;
- Analytical methods;
- Period to report the results; and
- Security of data and samples.

Laboratory samples were historically analysed using Atomic Absorption (AA) and X-Ray Fluorescence (XRF) methods. Since April 2011, Inductive Coupled Plasma (ICP) analysis has been undertaken and been validated with AA analysis. Up to 2014, 1 in 20 samples were analysed by both methods.

The following describes the basic analytical procedures:

- All samples are analysed by XRF for Cu, Pb, Zn, S, Fe, As, Sn, Sb, Bi, Se and In;
- Ag and Hg are analysed by ICP (Ag was previously analysed by the AA flame method and Hg by AA vapour);
- Copper XRF results that fall between 0.7% and 10% are re-analysed by ICP (previously by AA) and XRF results of greater than 10% are re-analysed by the electro-gravimetric method; and
- Zinc XRF results between 2% and 20% are re-analysed by ICP (previously by AA). Results greater than 20% are analysed by the volumetric method.

Analytical results are copied to a specific location on the mine server that has access restricted to the Chief, Resource and Database Geologists.

Comparison of the results of XRF analysis with other assay methods shows a slight analytical bias. The values of both copper and zinc are consistently lower (by approximately 4%) when assayed using XRF than by ICP, electro-gravimetric (for samples with Cu assays of greater than 10% Cu by XRF) or volumetric (for samples with Zn assays of greater than 20% Zn by XRF) methods. This bias is known to SOMINCOR and is continually monitored. No correction factor is applied by SOMINCOR to the XRF results. Summary results comparing the XRF analysis by Neves-Corvo laboratory and ICP, electro-gravimetric and volumetric analysis is shown in Figure 11.1 and Figure 11.2.

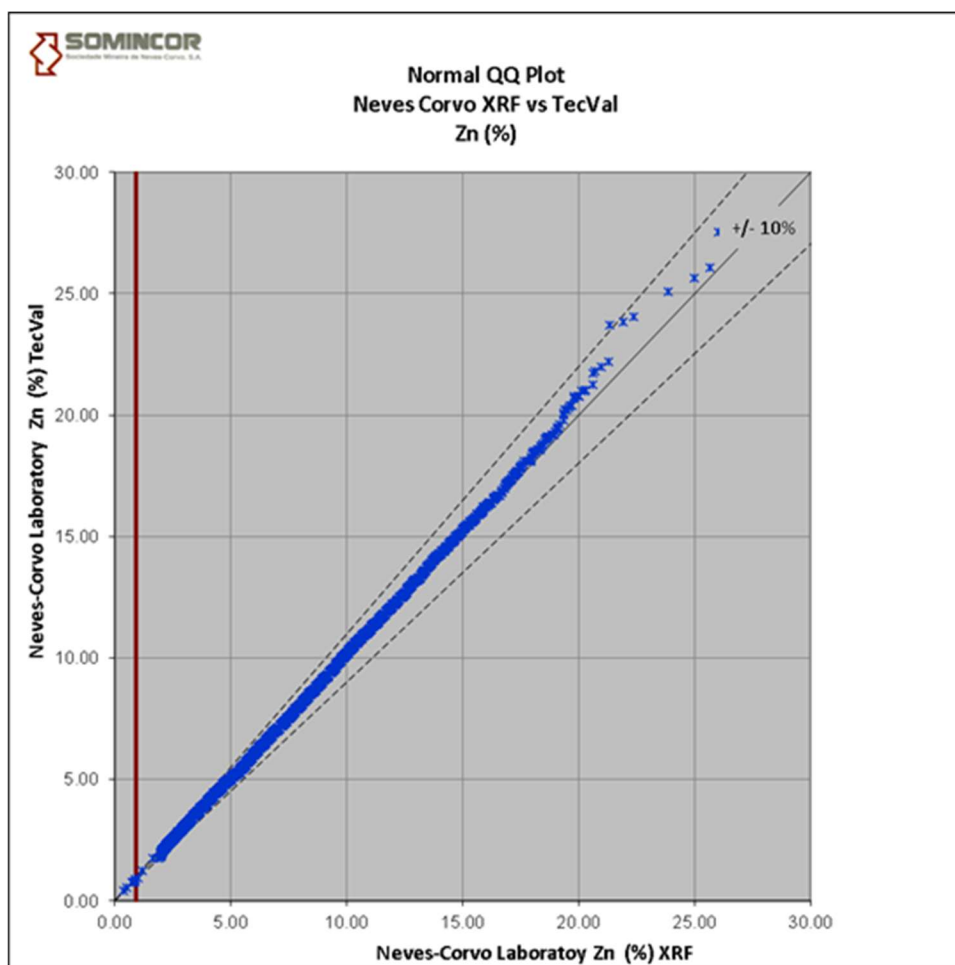
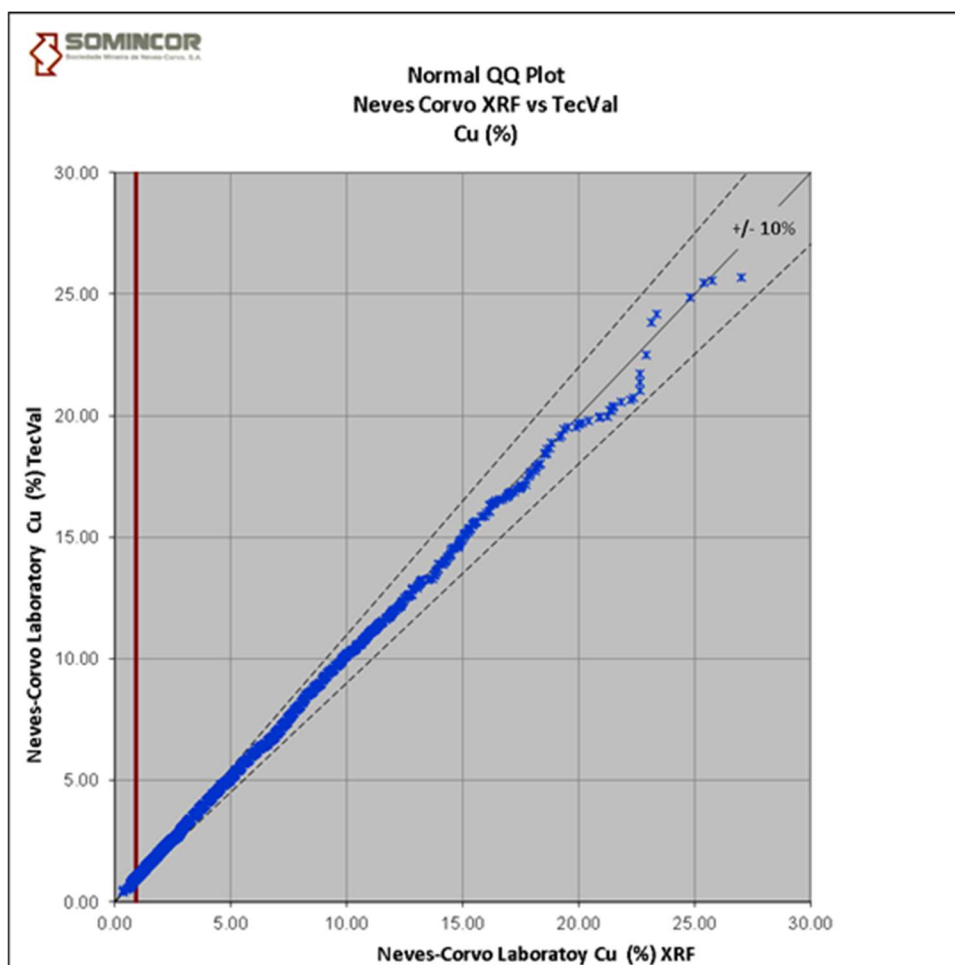

Figure 11.1: Neves-Corvo Laboratory (XRF) and TecVal (ICP and Volumetric) Analysis for Zn (%)





**Figure 11.2: Neves-Corvo Laboratory (XRF) and TecVal (ICP and Electro-Gravimetric) Analysis for Cu (%)**

For the purposes of Mineral Resource estimation for the deposits of Neves, Corvo, Graça, Zambujal, Lombador and Monte Branco, SOMINCOR uses the XRF analysis for Cu, Pb, Zn, S, Fe, As, Sn, Sb, Bi, Se and In, while AA / ICP analysis is used for Ag and Hg. The use of the wet chemical and ICP techniques are being continued to provide verification of the XRF results.

#### **11.5.2 ALS Vancouver (Semblana Exploration Samples)**

Exploration drill core samples from the Semblana exploration drilling (2010 – 2013) were analysed by ICP at ALS, Vancouver. The analysis methods used by ALS included the following:

- ME-ICP61+In;
- Au by AA23I;
- Sn by XRF10; and
- HG-CV42.

Over limit for Ag, Cu, Pb, Zn or As, were analysed by ME-OG46 (ICP).

## 11.6 Sample Security and Chain of Custody

Sample collection and transportation of drill core and face samples is undertaken by SOMINCOR geology department staff. Exploration core boxes are transported to the core logging facilities located at the Neves-Corvo mine site or the Lombador exploration facility. Once logging and sampling have been completed, core for archive storage is transferred to permanent storage facilities located at Neves-Corvo mine site or the Lombador exploration facility. The drill core boxes are covered, and the storage facilities are dry with internal lighting and metal shelving for storage. Pulp duplicate material is stored in the same facilities. To accommodate future drill core an additional storage facility is currently being prepared and is located adjacent to the existing facility at Neves-Corvo mine site. The authors consider the sample security and chain of custody procedures used by SOMINCOR to be of a high standard.

## 11.7 Quality Assurance and Quality Control Programmes

The implementation of a QA/QC programme is industry best practice and involves establishing appropriate procedures and the routine insertion of reference material, blanks and duplicates to monitor the sampling, sample preparation and analytical process. Analysis of QC data is made to assess the reliability of sample assay data and the confidence in the data used for the estimation.

Analysis of exploration samples (except for the Semblana samples from 2010 to 2013) is undertaken at the Neves-Corvo laboratory (ISO17025 accreditation). Sample flow through the laboratory is carefully monitored to ensure sample swapping does not occur. Equipment is calibrated using certified reference materials to ensure accuracy. Internal QA/QC procedures are undertaken by the laboratory. Repeat results are monitored and checks are made when results fall outside of the accepted repeatability ranges.

Primary samples submitted for analysis by the geological department are termed as Type 1. To detect possible changes or sample contamination, the following control samples are inserted with the drillhole samples:

- Type 2 (duplicate samples) - 3 control samples for every 100 samples submitted;
- Type 5 (duplicate samples) - internal control samples submitted by the Neves-Corvo laboratory;
- Type 10 (blank samples) - 4 control samples for every 100 samples submitted;
- Type 11 (copper standard reference material) - 2 control samples for every 100 samples submitted;
- Type 12 (zinc standard reference material) - 2 control samples for every 100 samples submitted; and
- Type 13 (commercially certified reference material) - Submitted for some surface exploration drilling programmes (Semblana).

Blank samples are submitted for analysis by the geological department as a control for the face samples. Face sample grades are further reviewed by SOMINCOR by comparison with close proximity drillhole data as detailed in Section 12.1.

QA/QC performance is continually monitored by both the Neves-Corvo laboratory and the geological department.

Samples assayed at the Neves-Corvo laboratory and samples from the Semblana exploration drilling (2010-2013) assayed at ALS, Vancouver, are considered separately in the following sections.

### 11.7.1 Neves-Corvo Laboratory Samples

A summary of the QA/QC performance of samples analysed at the Neves-Corvo laboratory from September 1, 2019 to June 30, 2021, is provided below.

#### 11.7.1.1 Internal Duplicates (Type 2)

Type 2 duplicates consist of pulp samples submitted by the geological department to monitor analytical precision and any potential bias associated with sample preparation such as improper cutting of core samples, lack of homogeneity or loss of fines during preparation. The samples are submitted to the Neves-Corvo laboratory for analysis by XRF and are compared with the Type 1 assay results (also by XRF). Example plots of the pulp duplicate analysis for zinc, lead and copper are shown in Figure 11.3 to Figure 11.5.

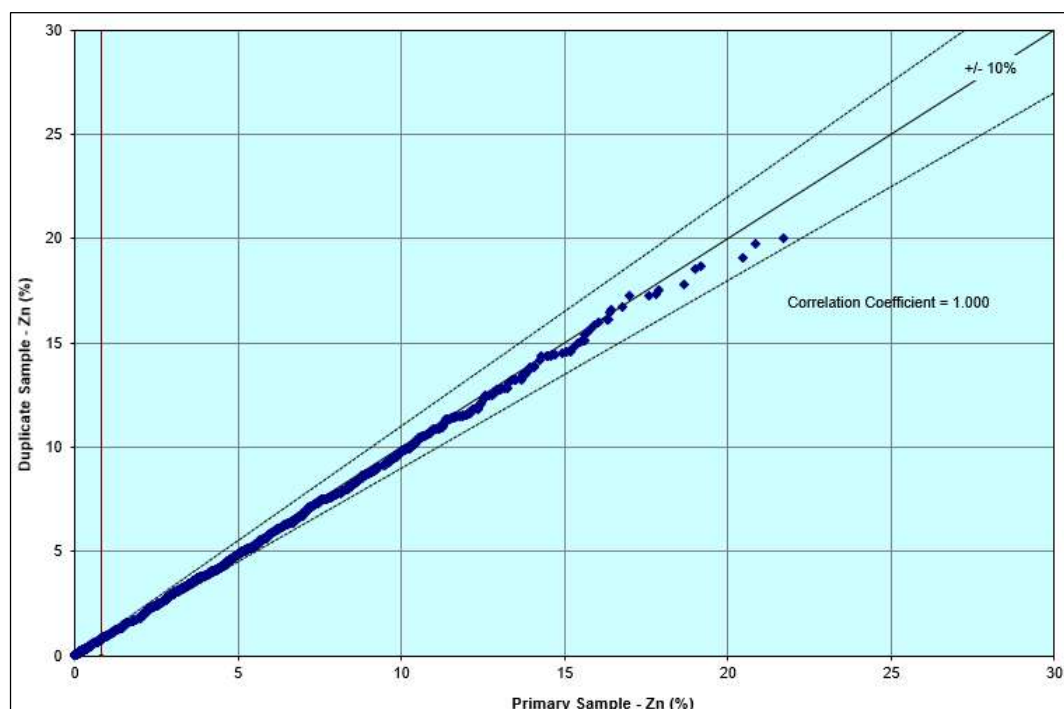

Figure 11.3: Pulp Duplicate Analysis for Zinc

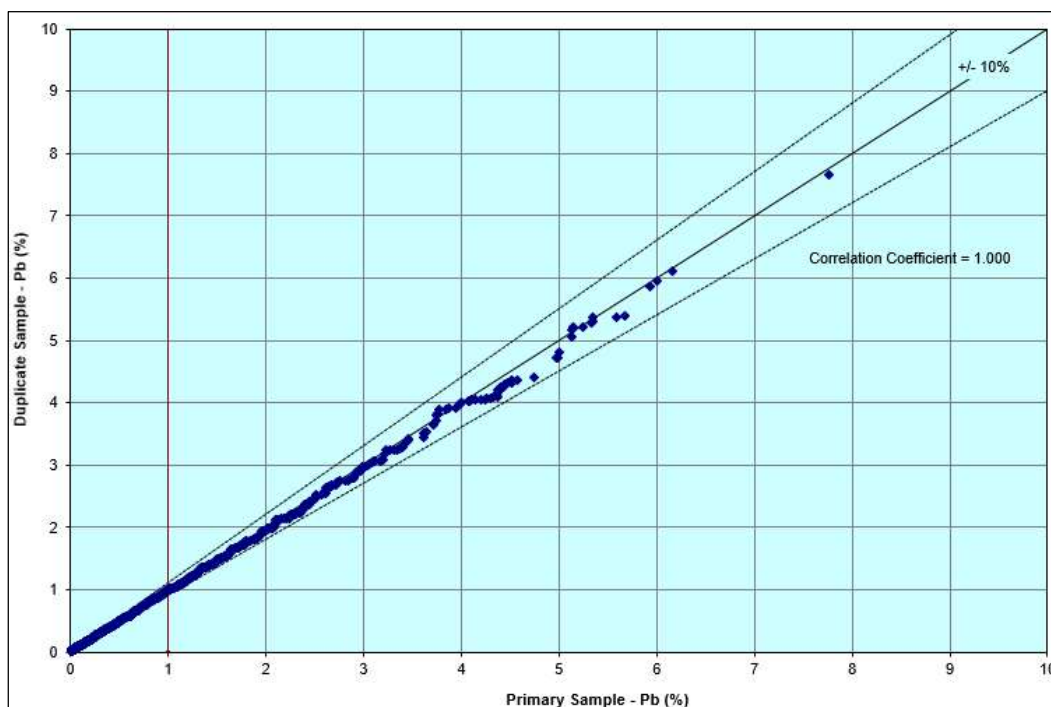

Figure 11.4: Pulp Duplicate Analysis for Lead

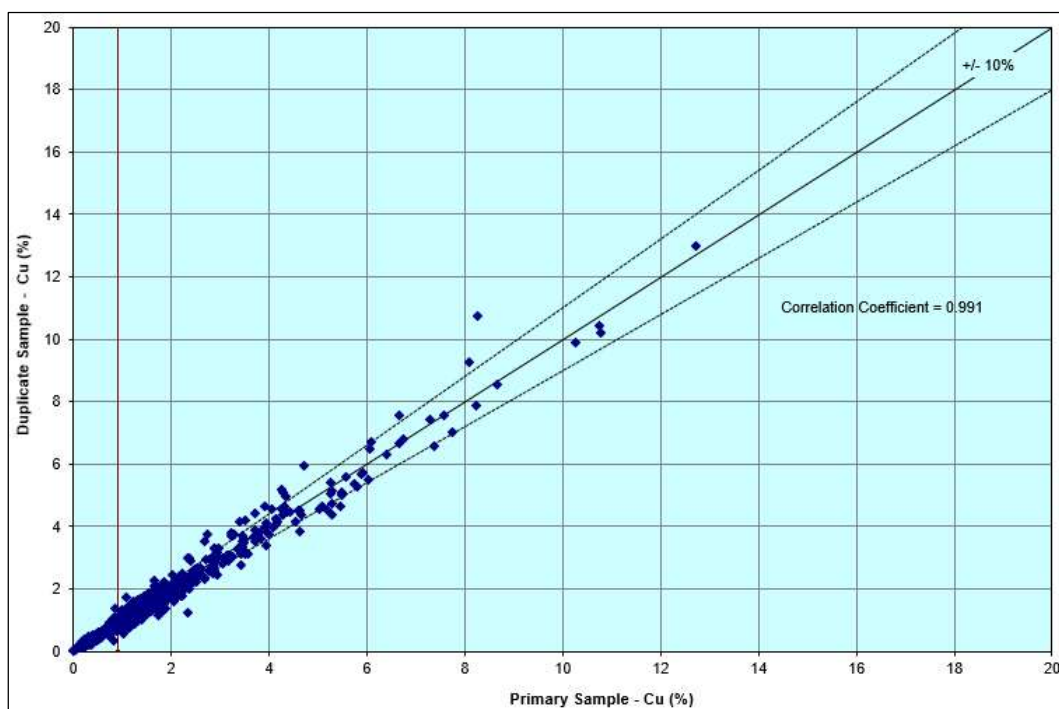

Figure 11.5: Pulp Duplicate Analysis for Copper

#### 11.7.1.2 Internal Duplicates (Type 5)

Type 5 duplicates consist of pulp samples taken by the Neves-Corvo laboratory during the sample preparation stage and are submitted for analysis by XRF as a laboratory control. The analysis results for the Type 5 duplicates are provided to the geological department and are used as an additional

check on the Type 1 results. Statistical analysis comparing the Type 1 and Type 5 duplicates shows a similar trend to the Type 1 and Type 2 duplicates and identified no significant issues.

### 11.7.1.3 Blanks (Type 10)

Blank material consisting of a greywacke rock is taken from non-mineralised core and is used to monitor contamination during sample preparation and analysis. Samples are taken by the geological department and included in the sample stream. Summary plots of the XRF analysis undertaken by the Neves-Corvo laboratory for zinc, lead and copper are shown in Figure 11.6 to Figure 11.8. The results show no evidence of systematic contamination; however, it is likely that the greywacke material is not totally barren.

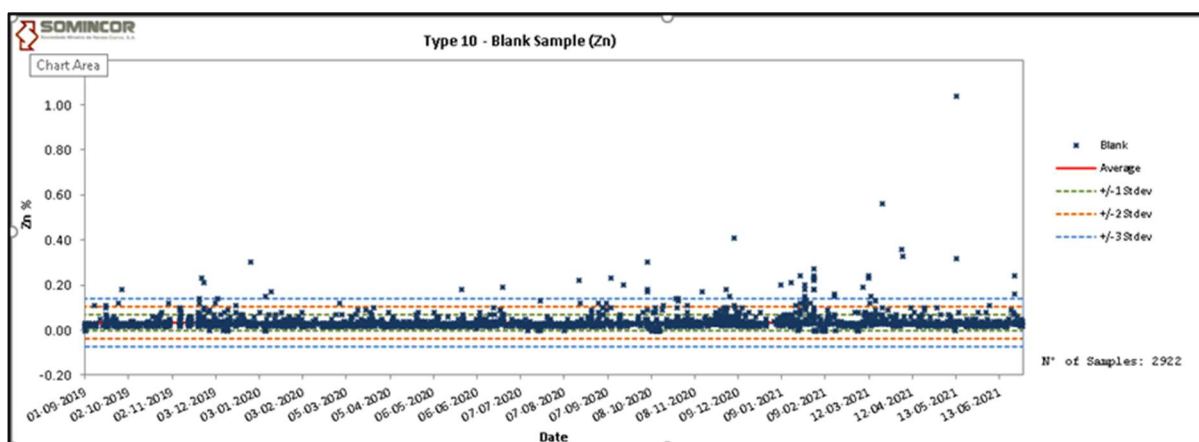

Figure 11.6: Blank Material Analysis for Zinc

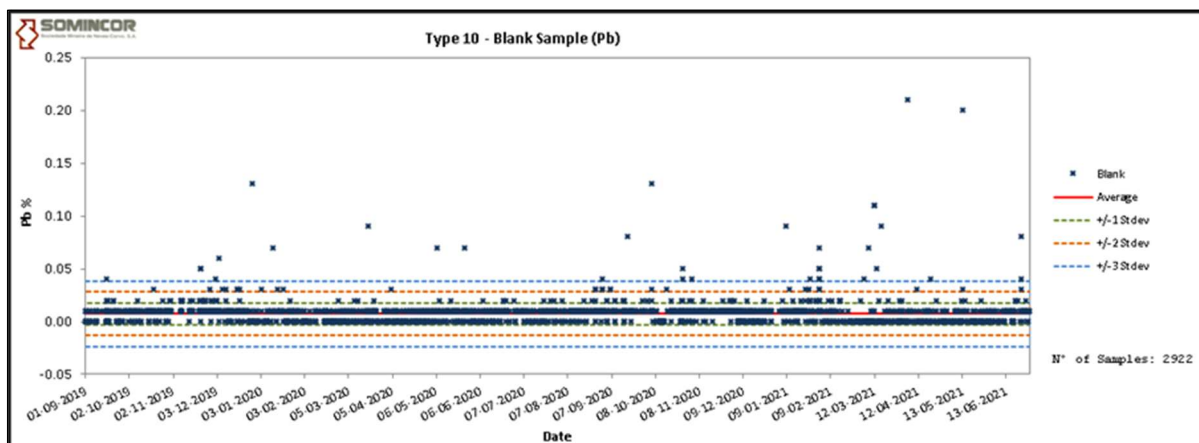
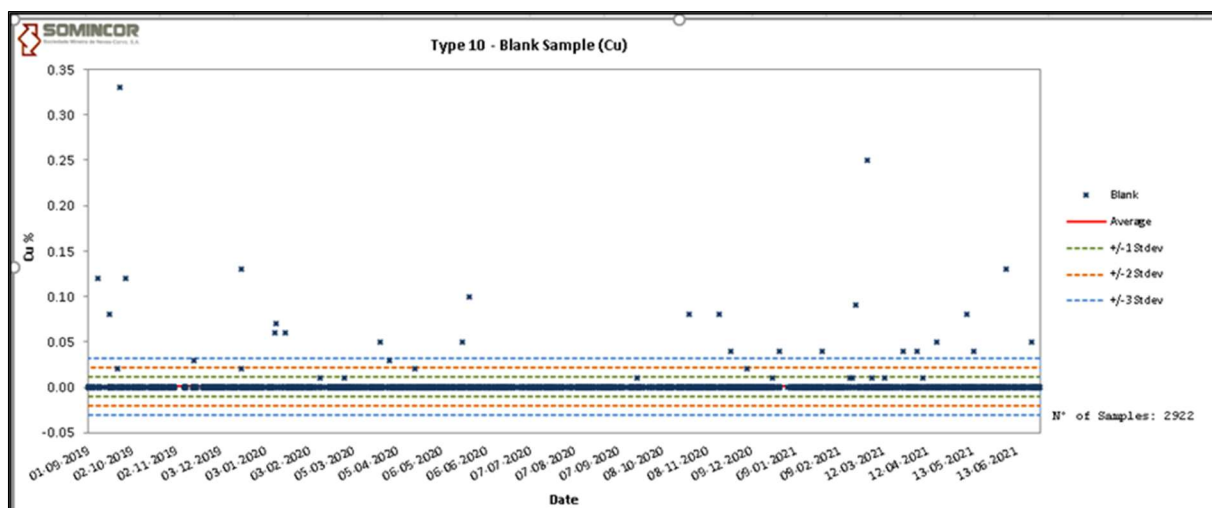

Figure 11.7: Blank Material Analysis for Lead



**Figure 11.8: Blank Material Analysis for Copper**

11.7.1.4 *Standard Reference Material (Type 11 and Type 12)*

Standard reference materials (SRMs) are prepared in-house by SOMINCOR from pulp reject material. Type 11 is a copper SRM with a mean grade of 2.837% Cu and Type 12 is a zinc SRM with mean grades of 5.068% Zn and 2.23% Pb. Results of the analysis are shown in Figure 11.9 to Figure 11.11 and generally show reasonable levels of accuracy, however, the SRM's are of a lower quality than commercially certified reference material and deviation from the mean grades is observed. In addition, there is a tendency for the SRM analysis to report lower grades than the mean values with some evidence of drift that may result from deterioration of the SRMs over time.

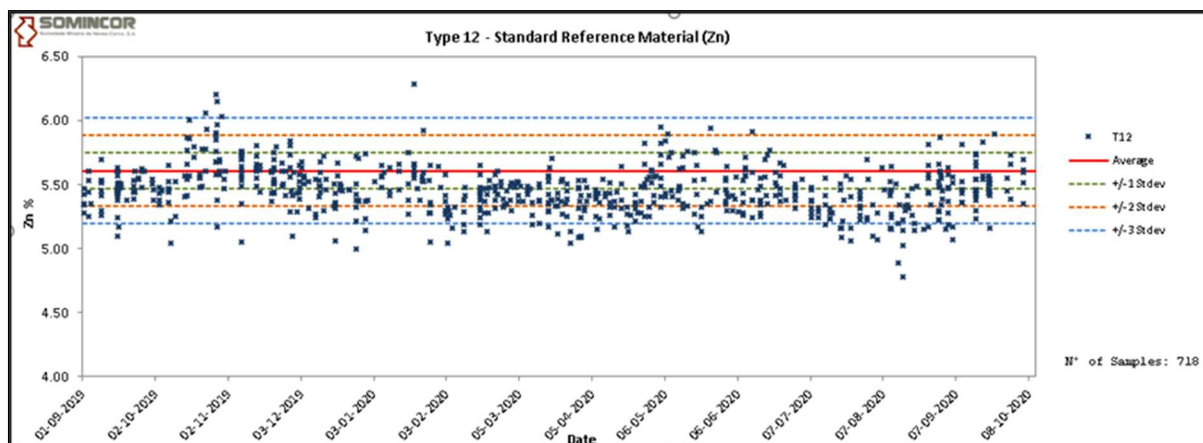

**Figure 11.9: Analysis of Type 12 Standard Reference Material for Zinc**

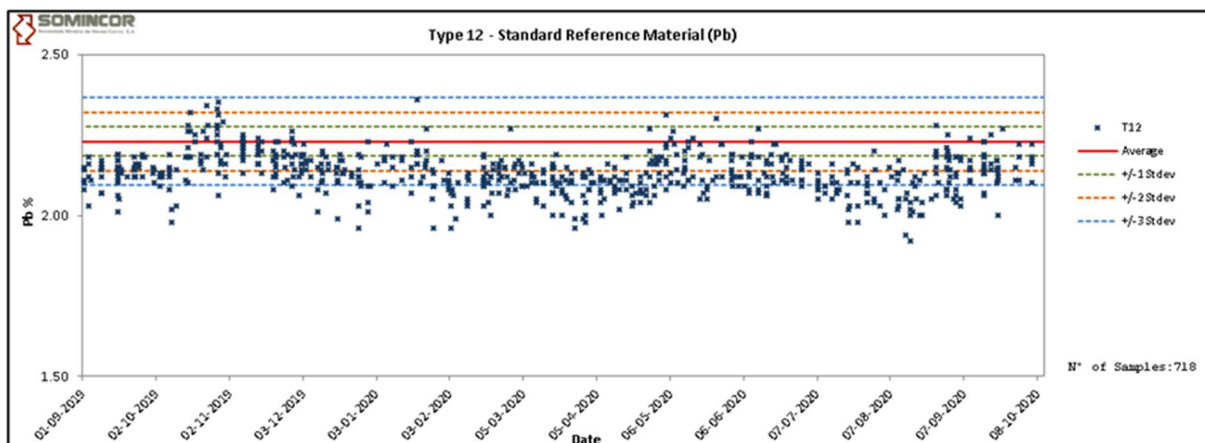

**Figure 11.10: Analysis of Type 12 Standard Reference Material for Lead**

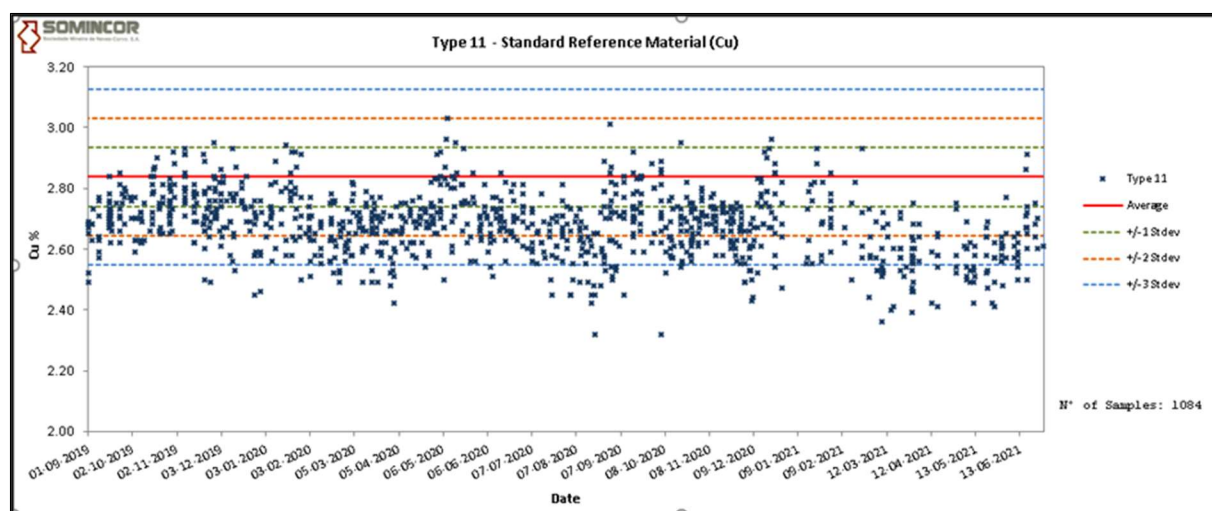

**Figure 11.11: Analysis of Type 11 Standard Reference Material for Copper**

### 11.7.2 Semblana Exploration Drill Samples (2010-2013)

A summary of the QA/QC used as a control for the primary samples analysed by ALS, Vancouver is given in the sections below. Sample insertion rates for the control samples were 1 control sample for every 5 samples.

#### 11.7.2.1 Duplicates (Type 2)

Duplicate analysis was undertaken at the Neves-Corvo laboratory using returned coarse reject material. The following procedures were used:

- Selection of 5% of the returned coarse rejects, each batch was represented;
- Selection of coarse rejects was based on:
  - Grades of 0.7-1% Cu;
  - Grades of (2-3% Cu); and
  - Grades of <0.7% Cu.

- All selected coarse rejects were homogenised and pulverised; and
- Final sample weight provided for analysis was 150g.

A summary of the primary analysis by ALS and the duplicate analysis by the Neves-Corvo laboratory for copper is shown in Figure 11.12.

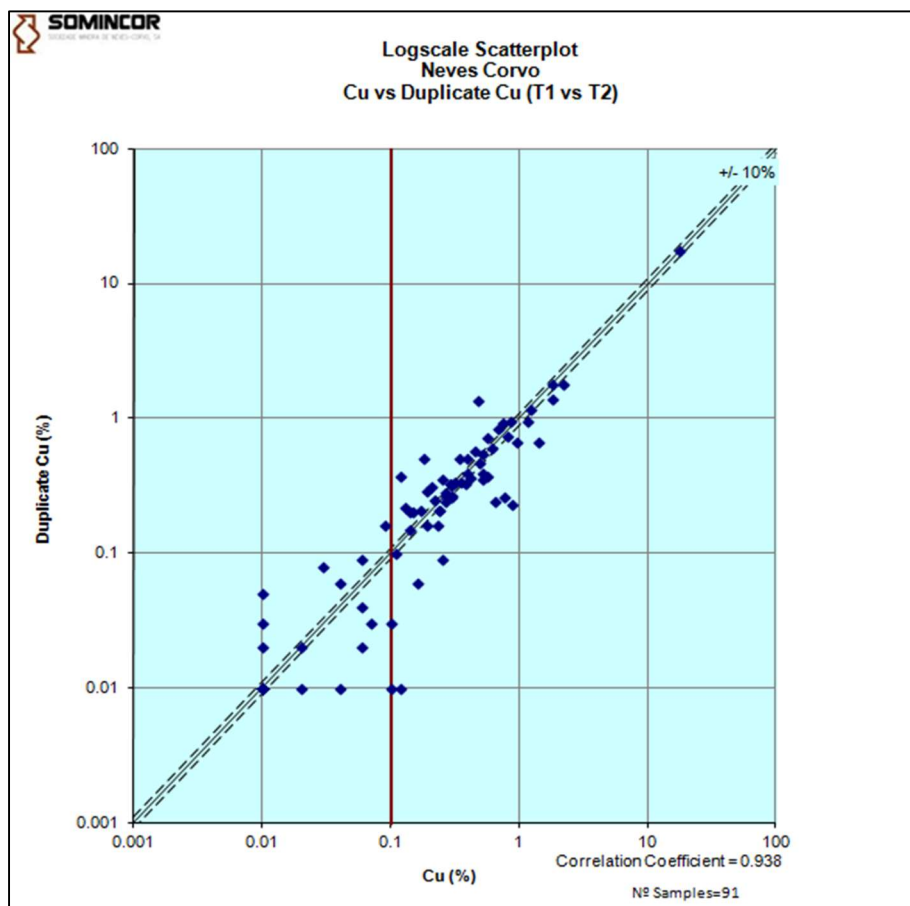
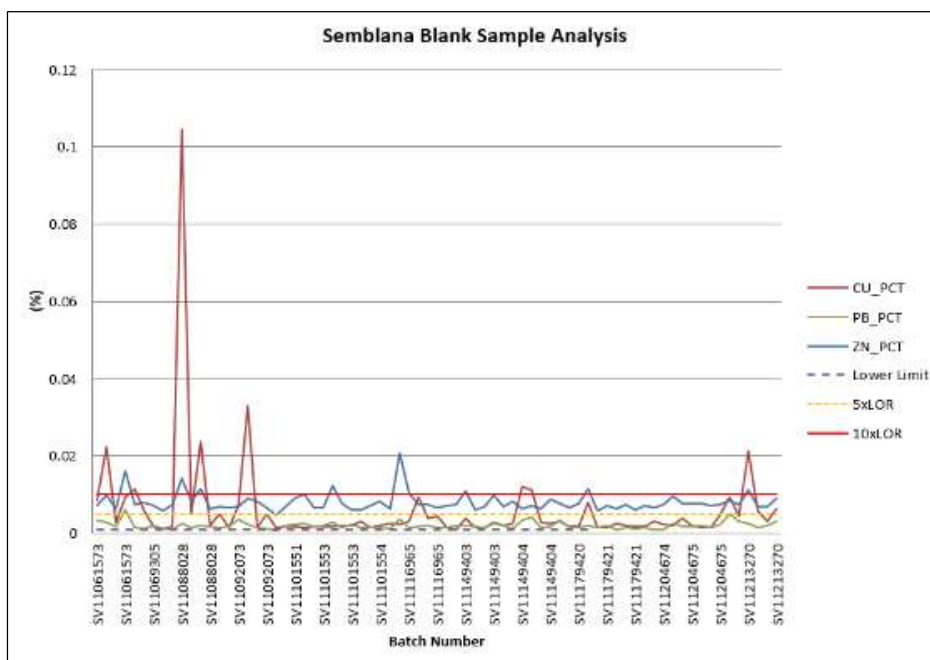

**Figure 11.12: Pulp Duplicate Analysis for Copper (ALS vs Neves-Corvo Laboratories)**

#### 11.7.2.2 Blanks (Type 10)

Greywacke rock (100g samples) were selected from non-mineralised core and used as blank material to monitor contamination in the sample preparation and analysis by ALS. The results for copper, zinc and lead from the analysis by ALS are shown in Figure 11.13. Again, the results indicate that the incidents of contamination are low, although the blank material used is again not considered to be totally barren.





**Figure 11.13: Blank Sample Analysis (Type10) for Copper, Zinc and Lead (ALS)**

11.7.2.3 Certified Reference Material (Type 13)

Two commercial CRMs were used during the analysis of the Semblana exploration samples and these were analysed by ALS. The CRMs consisted of base metal reference material produced by Geostats Pty Ltd. A summary of the CRMs is shown in Table 11.3 and summary plots of the CRM analysis by ALS for copper, zinc, silver and lead are shown in Figure 11.14 to Figure 11.17.

**Table 11.3: Summary of CRMs used in Analysis of Semblana Samples**

Supplier	Standard	Grade Cu (%)	Cu Standard Deviation	Grade Zn (ppm)	Zn Standard Deviation	Grade Pb (ppm)	Pb Standard Deviation	Grade Ag (ppm)	Ag Standard Deviation
Geostats	GBM308-12	0.516	0.017	4.914	0.198	2.145	0.097	43.0	2.4
Geostats	GBM308-14	3.719	0.122	1.903	0.084	0.651	0.023	40.20	2.6

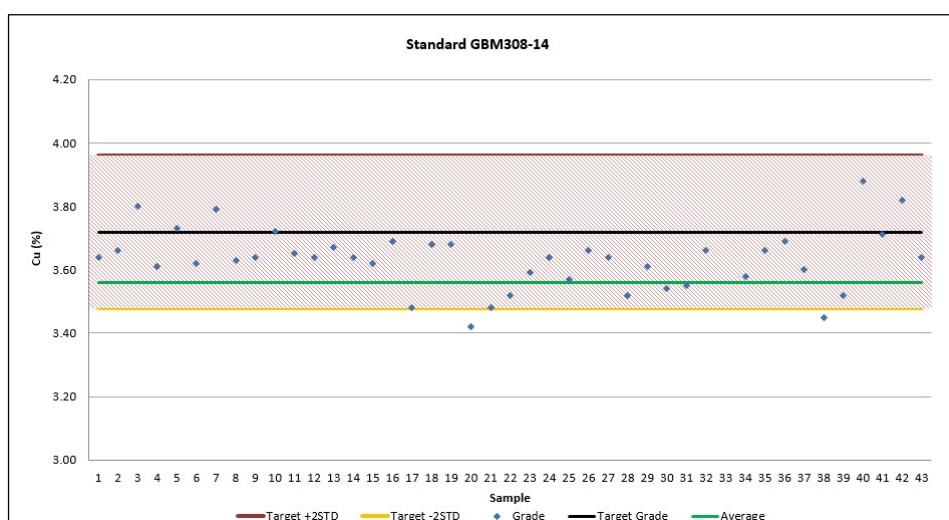

**Figure 11.14: Analysis of CRM GBM308-14 for Copper**

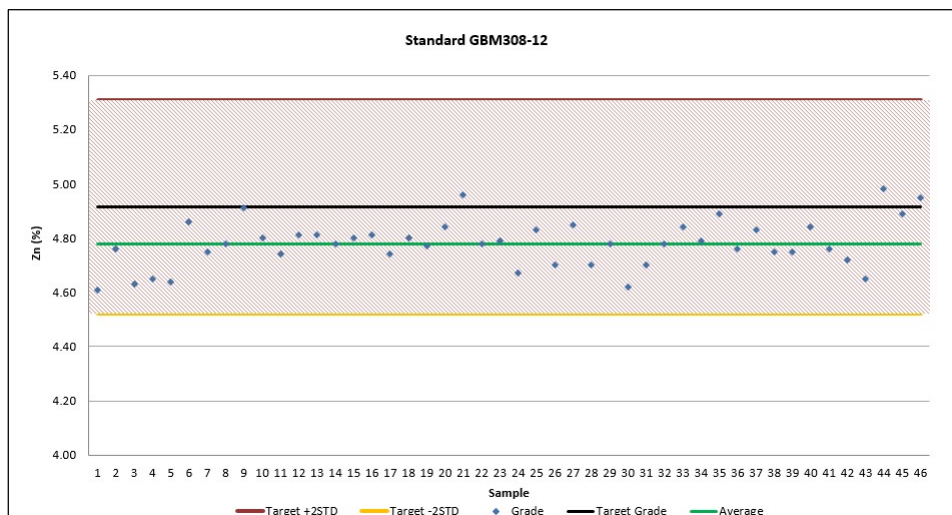

**Figure 11.15: Analysis of CRM GBM308-12 for Zinc**

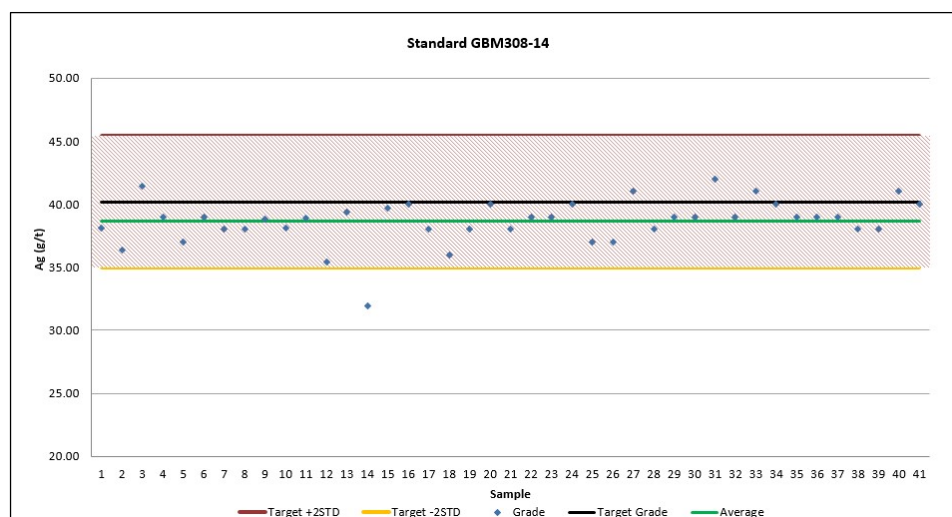

**Figure 11.16: Analysis of CRM GBM308-14 for Silver**

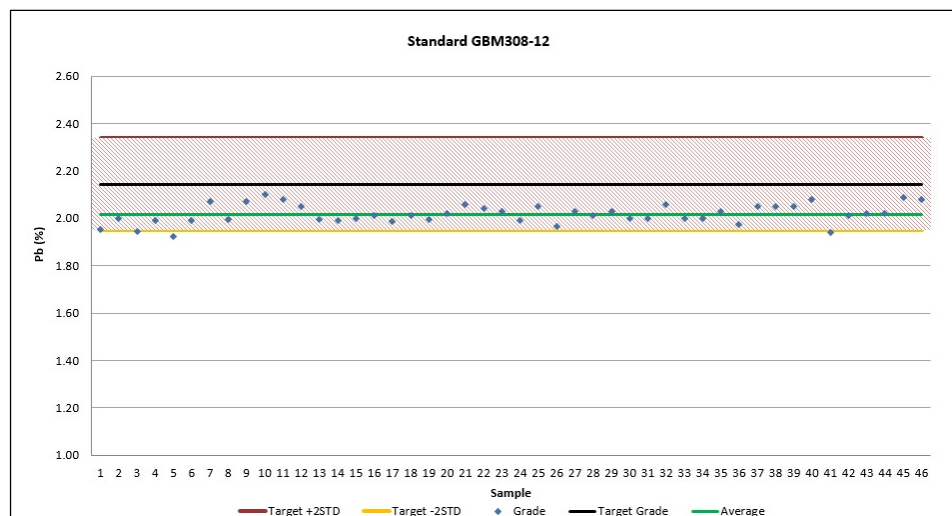

**Figure 11.17: Analysis of CRM GBM308-12 for Lead**

### **11.7.3 Adequacy of Procedures**

The authors consider the sample preparation, security and analytical procedures for samples sent to both the Neves-Corvo and ALS laboratories have been conducted in accordance with acceptable industry standards and the assay results generated following these procedures are suitable for use in Mineral Resource estimation.

## 12 DATA VERIFICATION

### 12.1 Data Verification by SOMINCOR

Data entry, validation, storage and database maintenance is carried out by SOMINCOR staff using established procedures. Data used for the Mineral Resource estimates included face samples and diamond core drilling (exploration and infill). All data are stored in a central SQL database located at the Neves-Corvo mine offices. The SQL database has a series of automated validation tools during import and export for error identification. The quality of the assay data contained within the databases is monitored by SOMINCOR staff using established QA/QC procedures.

Annual reviews of the assays from face samples are undertaken by the geological department and a sampling bias resulting in higher Cu grades within the copper stockwork has been detected when compared to adjacent drillholes (located <3m from the face samples). As a result, the Cu grades of face samples from the copper stockwork are factored by the geological department during the compositing stage of Mineral Resource estimation. The factoring adjusts the Cu assays of the face samples to produce a population distribution the same as that observed in the histograms of the drillholes. The factoring of the Cu assays of the face samples in the copper stockwork for each deposit are shown in Table 12.1.

Hist	Neves		Corvo		Graça		Zambujal		Lombador	
	Cu (%) <sup>1</sup>	Cu (%) <sup>2</sup>	Cu (%) <sup>1</sup>	Cu (%) <sup>2</sup>	Cu (%) <sup>1</sup>	Cu (%) <sup>2</sup>	Cu (%) <sup>1</sup>	Cu (%) <sup>2</sup>	Cu (%) <sup>1</sup>	Cu (%) <sup>2</sup>
0	0.70	0.70	0.70	0.70	0.72	0.70	0.70	0.70	0.72	0.70
1	0.72	0.71	0.74	0.72	0.82	0.74	0.72	0.72	0.75	0.71
2	0.76	0.73	0.80	0.77	0.89	0.84	0.75	0.73	0.77	0.71
3	0.78	0.75	0.86	0.82	0.97	0.88	0.78	0.74	0.79	0.71
4	0.82	0.76	0.89	0.85	1.00	0.91	0.81	0.77	0.83	0.73
5	0.85	0.78	0.96	0.88	1.04	0.91	0.83	0.77	0.85	0.76
6	0.88	0.79	1.02	0.90	1.11	0.92	0.86	0.79	0.88	0.80
7	0.90	0.81	1.08	0.95	1.22	0.97	0.89	0.80	0.89	0.80
8	0.93	0.81	1.15	1.01	1.44	1.01	0.92	0.82	0.90	0.81
9	0.95	0.83	1.21	1.04	1.48	1.04	0.97	0.83	0.95	0.82
10	0.98	0.85	1.27	1.07	1.52	1.10	1.02	0.85	0.97	0.83
11	1.00	0.86	1.30	1.09	1.56	1.12	1.04	0.86	1.00	0.85
12	1.04	0.88	1.33	1.13	1.58	1.17	1.06	0.90	1.00	0.86
13	1.07	0.90	1.39	1.15	1.78	1.22	1.09	0.91	1.00	0.87
14	1.10	0.91	1.46	1.18	1.91	1.23	1.12	0.92	1.06	0.87
15	1.14	0.93	1.58	1.22	2.02	1.29	1.15	0.93	1.11	0.88
16	1.17	0.94	1.63	1.28	2.08	1.31	1.18	0.95	1.12	0.89
17	1.20	0.96	1.67	1.34	2.12	1.35	1.21	0.99	1.15	0.90
18	1.23	0.98	1.76	1.38	2.19	1.38	1.22	1.02	1.16	0.92
19	1.26	1.00	1.83	1.41	2.22	1.40	1.26	1.04	1.17	0.92
20	1.30	1.03	1.92	1.45	2.43	1.41	1.29	1.07	1.19	0.93
21	1.33	1.06	2.07	1.50	2.46	1.43	1.32	1.08	1.22	0.96
22	1.37	1.07	2.12	1.56	2.60	1.48	1.37	1.10	1.24	0.97
23	1.41	1.09	2.20	1.60	2.64	1.50	1.41	1.12	1.26	0.97
24	1.43	1.10	2.24	1.65	2.74	1.54	1.44	1.13	1.28	0.97
25	1.48	1.12	2.31	1.68	2.86	1.59	1.49	1.15	1.31	0.99
26	1.51	1.15	2.38	1.76	2.96	1.69	1.53	1.16	1.33	0.99

**Table 12.1: Histogram Distributions for Factoring Cu Grades of Stockwork Face Samples**

Hist	Neves		Corvo		Graça		Zambujal		Lombador	
	Cu (%) <sup>1</sup>	Cu (%) <sup>2</sup>	Cu (%) <sup>1</sup>	Cu (%) <sup>2</sup>	Cu (%) <sup>1</sup>	Cu (%) <sup>2</sup>	Cu (%) <sup>1</sup>	Cu (%) <sup>2</sup>	Cu (%) <sup>1</sup>	Cu (%) <sup>2</sup>
27	1.54	1.16	2.42	1.82	3.04	1.77	1.57	1.18	1.42	0.99
28	1.58	1.18	2.48	1.85	3.16	1.81	1.65	1.19	1.47	1.01
29	1.62	1.21	2.57	1.91	3.25	1.88	1.67	1.21	1.49	1.01
30	1.65	1.23	2.65	1.98	3.38	1.93	1.69	1.25	1.51	1.03
31	1.69	1.25	2.71	2.05	3.45	1.97	1.75	1.27	1.53	1.04
32	1.74	1.28	2.82	2.10	3.51	2.02	1.80	1.30	1.55	1.05
33	1.78	1.33	2.87	2.15	3.61	2.13	1.86	1.32	1.65	1.05
34	1.80	1.35	2.96	2.22	3.66	2.20	1.88	1.35	1.67	1.06
35	1.85	1.37	3.01	2.29	3.77	2.28	1.90	1.36	1.71	1.10
36	1.89	1.40	3.11	2.35	3.82	2.33	1.97	1.37	1.75	1.19
37	1.93	1.42	3.18	2.41	4.01	2.37	2.02	1.38	1.77	1.21
38	1.97	1.44	3.23	2.45	4.07	2.43	2.06	1.41	1.82	1.23
39	2.00	1.47	3.29	2.53	4.21	2.52	2.09	1.42	1.84	1.24
40	2.05	1.50	3.38	2.61	4.26	2.61	2.11	1.44	1.91	1.27
41	2.10	1.55	3.48	2.71	4.31	2.73	2.14	1.46	1.96	1.31
42	2.13	1.59	3.55	2.76	4.34	2.79	2.17	1.48	1.97	1.32
43	2.19	1.62	3.61	2.81	4.42	2.89	2.21	1.51	1.98	1.33
44	2.23	1.64	3.70	2.88	4.55	3.03	2.25	1.55	2.02	1.34
45	2.26	1.67	3.81	2.99	4.62	3.13	2.26	1.57	2.07	1.35
46	2.30	1.70	3.88	3.08	4.72	3.17	2.32	1.59	2.10	1.36
47	2.35	1.74	3.94	3.17	4.77	3.21	2.36	1.64	2.15	1.37
48	2.39	1.78	3.99	3.26	4.85	3.25	2.41	1.68	2.23	1.42
49	2.43	1.81	4.11	3.37	4.87	3.30	2.44	1.70	2.25	1.44
50	2.48	1.84	4.24	3.45	5.05	3.43	2.51	1.72	2.30	1.47
51	2.54	1.88	4.33	3.54	5.26	3.59	2.55	1.73	2.34	1.52
52	2.59	1.92	4.44	3.60	5.35	3.66	2.58	1.77	2.38	1.52
53	2.64	1.98	4.52	3.69	5.64	3.75	2.66	1.79	2.39	1.56
54	2.71	2.03	4.65	3.80	5.80	3.90	2.68	1.82	2.44	1.57
55	2.77	2.07	4.73	3.90	5.99	4.08	2.71	1.85	2.49	1.62
56	2.83	2.10	4.85	4.04	6.36	4.23	2.73	1.88	2.53	1.63
57	2.91	2.15	4.90	4.14	6.51	4.25	2.79	1.91	2.65	1.64
58	2.99	2.20	4.98	4.23	6.64	4.45	2.81	1.95	2.66	1.64
59	3.04	2.23	5.08	4.35	6.76	4.58	2.87	1.99	2.71	1.65
60	3.12	2.28	5.22	4.46	6.85	4.73	2.94	2.01	2.78	1.67
61	3.16	2.34	5.39	4.61	7.01	4.77	3.00	2.02	2.85	1.70
62	3.27	2.36	5.52	4.73	7.10	4.83	3.04	2.05	2.87	1.82
63	3.35	2.41	5.64	4.87	7.27	4.89	3.10	2.09	2.91	1.89
64	3.43	2.47	5.79	4.96	7.30	4.92	3.16	2.12	2.93	1.92
65	3.55	2.54	5.92	5.12	7.67	5.02	3.22	2.15	3.07	2.01
66	3.62	2.61	6.10	5.22	7.77	5.22	3.26	2.18	3.08	2.05
67	3.72	2.66	6.23	5.40	7.99	5.53	3.32	2.27	3.10	2.09
68	3.81	2.75	6.37	5.59	8.19	5.70	3.40	2.33	3.17	2.16
69	3.91	2.84	6.54	5.75	8.32	5.82	3.45	2.38	3.22	2.19
70	4.06	2.89	6.75	5.93	8.77	6.35	3.49	2.41	3.34	2.21
71	4.15	2.96	6.97	6.18	8.85	6.50	3.54	2.46	3.45	2.25
72	4.22	3.09	7.18	6.35	9.13	6.75	3.63	2.52	3.51	2.26
73	4.33	3.16	7.36	6.49	9.31	6.78	3.69	2.55	3.56	2.28
74	4.45	3.24	7.67	6.60	9.65	7.08	3.74	2.61	3.67	2.31
75	4.55	3.33	7.83	6.83	10.14	7.21	3.86	2.66	3.84	2.35
76	4.66	3.40	8.06	7.01	10.31	7.38	3.88	2.70	3.94	2.38
77	4.76	3.49	8.20	7.16	10.70	7.57	3.93	2.74	4.13	2.51
78	4.83	3.61	8.45	7.43	10.85	8.11	3.99	2.78	4.21	2.65
79	4.93	3.72	8.81	7.71	11.07	8.77	4.04	2.87	4.23	2.71
80	5.07	3.81	9.01	7.94	11.28	9.10	4.17	3.02	4.31	2.79

**Table 12.1: Histogram Distributions for Factoring Cu Grades of Stockwork Face Samples**

Hist	Neves		Corvo		Graça		Zambujal		Lombador	
	Cu (%) <sup>1</sup>	Cu (%) <sup>2</sup>	Cu (%) <sup>1</sup>	Cu (%) <sup>2</sup>	Cu (%) <sup>1</sup>	Cu (%) <sup>2</sup>	Cu (%) <sup>1</sup>	Cu (%) <sup>2</sup>	Cu (%) <sup>1</sup>	Cu (%) <sup>2</sup>
81	5.25	3.93	9.34	8.20	11.67	9.15	4.30	3.12	4.49	2.95
82	5.38	4.08	9.61	8.42	12.20	9.36	4.48	3.17	4.58	3.14
83	5.59	4.20	9.93	8.69	12.64	9.57	4.56	3.29	4.67	3.20
84	5.73	4.32	10.18	9.03	13.25	9.83	4.67	3.36	4.82	3.28
85	5.94	4.47	10.57	9.20	14.05	10.21	4.83	3.42	4.92	3.47
86	6.12	4.69	10.98	9.58	14.42	10.64	4.92	3.52	5.01	3.50
87	6.30	4.89	11.46	9.92	14.68	10.99	5.11	3.66	5.28	3.77
88	6.50	5.09	12.21	10.45	15.46	11.54	5.31	3.77	5.36	4.08
89	6.76	5.37	12.83	10.77	16.39	11.87	5.42	3.89	5.71	4.16
90	7.03	5.68	13.32	11.23	17.12	12.14	5.64	4.03	5.93	4.31
91	7.31	6.07	13.98	11.81	17.41	13.23	5.78	4.23	6.24	4.38
92	7.65	6.32	14.61	12.50	17.73	14.14	6.07	4.41	6.57	4.45
93	8.02	6.69	15.74	13.01	18.54	14.75	6.32	4.67	6.80	4.50
94	8.37	7.06	17.21	13.91	18.82	15.29	6.46	4.84	7.43	4.65
95	9.00	7.69	17.94	14.90	20.39	16.20	6.98	5.15	8.50	4.74
96	9.72	8.15	19.06	16.22	22.04	16.58	7.57	5.68	8.86	4.93
97	10.81	8.72	20.48	17.30	23.84	17.82	8.43	6.33	9.69	5.73
98	11.80	9.85	22.43	19.82	24.65	20.53	9.42	6.85	10.23	5.97
99	13.53	12.55	24.84	23.39	26.75	20.96	10.52	7.51	11.27	7.01
100	21.90	21.78	32.02	33.47	29.44	26.05	17.14	14.54	12.34	7.55

Cu (%)<sup>1</sup> - Original Cu grade  
 Cu (%)<sup>2</sup> - Cu grade after factoring

## 12.2 Database Cut-Off Dates

Cut-off dates used to close the databases prior to Mineral Resource estimation are shown in Table 12.2. No cut-off dates were required to databases of Monte Branco or Semblana as drilling is not ongoing at these deposits.

**Table 12.2: Database Cut-Off Dates by Deposit**

Deposit	Face Samples Cut-Off Date	Drillhole Samples Cut-Off Date
Corvo	February 7, 2022	February 7, 2022
Graça	March 17, 2022	March 1, 2022
Lombador	January 31, 2022	January 31, 2022
Neves	January 31, 2022	January 31, 2022
Zambujal	February 24, 2022	February 24, 2022
Monte Branco	N/A	No cut-off date required
Semblana	N/A	No cut-off date required

## 12.3 Data Verification by The Authors

### 12.3.1 Site Visit

A site visit to the Neves-Corvo Mine was undertaken by the authors on November 2 to 3, 2022 and included the following inspections:

- Extent of exploration work completed to date;

- Review of drill core logging, sampling, sample preparation, analysis and QA/QC procedures;
- Inspection of the core logging, sampling and storage facilities;
- Inspection of selected drill core to confirm the nature of the mineralisation and the geological descriptions;
- Inspection of selected drill core to confirm the down hole depths of geological contacts compared with the drillhole logging data; and
- Inspection of geology and mineralisation in underground workings at Lombador.

### **12.3.2 Database Review**

The databases were received by the authors in Microsoft® Excel format. A review of the databases was carried out by the authors and included the following:

- Verification that collar coordinates coincide with underground workings or topographical surfaces;
- Verification that downhole survey azimuth and inclination values display consistency;
- Evaluation of minimum and maximum grade values;
- Evaluation of minimum and maximum sample lengths;
- Assessing for inconsistencies in spelling or coding (typographic and case sensitive errors);
- Ensuring full data entry and that a specific data type (collar, survey, lithology and assay) is not missing and assessing for sample gaps or overlaps; and
- Review of QA/QC procedures and assay data (as detailed in Section 11).

Overall, no significant issues in terms of data collection, data entry or data storage were identified by the qualified persons in a review of the electronic databases.

### **12.3.3 Limitations**

The authors have not undertaken any independent check analysis of samples nor conducted any twin hole drilling to confirm the assays contained in the electronic databases. The authors do not consider referee samples necessary given:

- The procedures used by SOMINCOR for sampling, logging, sample preparation, analysis, sample security and data storage are considered to be robust;
- Routine monitoring of QA/QC data demonstrates an acceptable level of accuracy and precision; and
- Neves-Corvo is a mature operation with a significant production history. On-going reconciliation studies (detailed in Section 14) are undertaken by SOMINCOR and show that the Mineral Resource models compare sufficiently with monthly mine production data.

#### **12.3.4 Adequacy of Data**

The verification procedures carried out by the authors confirmed the integrity of the data contained in the electronic databases. The authors consider the databases to be suitable for the purposes of Mineral Resource estimation and for the purposes of this Technical Report.



## 13 MINERAL PROCESSING AND METALLURGICAL TESTING

### 13.1 XPS Copper Variability Testwork (2018)

#### 13.1.1 Introduction

Seven variability samples were selected for this program as detailed below:

- FC-Shale Hosted;
- FC-Volcanic Hosted Above;
- MC Below Average Fe:Cu (<6.61);
- MC above Average Fe:Cu (>6.61);
- MCZ Low Zn:Cu (<0.92);
- MCZ High Zn:Cu (>0.92); and
- MC High Pb:Cu (>0.3).

#### 13.1.2 Head Sample Analysis

The head assay data is given in Table 13.1.

Sample	Cu (%)	Pb (%)	Zn (%)	Fe (%)	S (%)	As (%)	Sb (%)	Si (%)
FC-Shale Hosted	2.25	0.08	0.45	27.97	19.63	0.22	0.01	11.47
FC - Volcanic Hosted Above	2.12	0.13	0.65	25.33	15.83	0.51	0.01	14.57
MC Below avg Fe:Cu (<6.61)	10.04	0.75	0.5	34.43	38.37	1.37	1.23	3.39
MC Above avg Fe:Cu (>6.61)	2.2	0.28	0.14	40.07	45.9	0.43	0.05	3.72
MCZ(5C) Zn:Cu<0.92	13.7	0.24	5.18	33.73	40.53	1.29	0.19	0.1
MCZ(5C) Zn:Cu(>0.92)	4.25	0.86	7.6	37.83	40.67	0.6	0.13	0.74
MC Pb:Cu (>0.3)	2.38	2.58	0.81	36.53	39.9	0.71	0.19	4.18

Copper head grades ranged from 2.1XPS% to 10.0% Cu and Fe grades from 25.3% to 40.07% Fe. The FC stockwork ore types contained 11.47% and 14.57% SiO<sub>2</sub>. Zinc levels were generally below 1% with the exception of the two MCZ samples where the grades were >5%.

#### 13.1.3 Mineralogy

Mineralogical analysis was completed using QEMSCAN using sub-samples extracted from confirmation grinds at the P80 target of 60µm. Each sample was deslimed to remove -3µm material.

The modal mineralogy of the seven composites is shown in Figure 13.1.

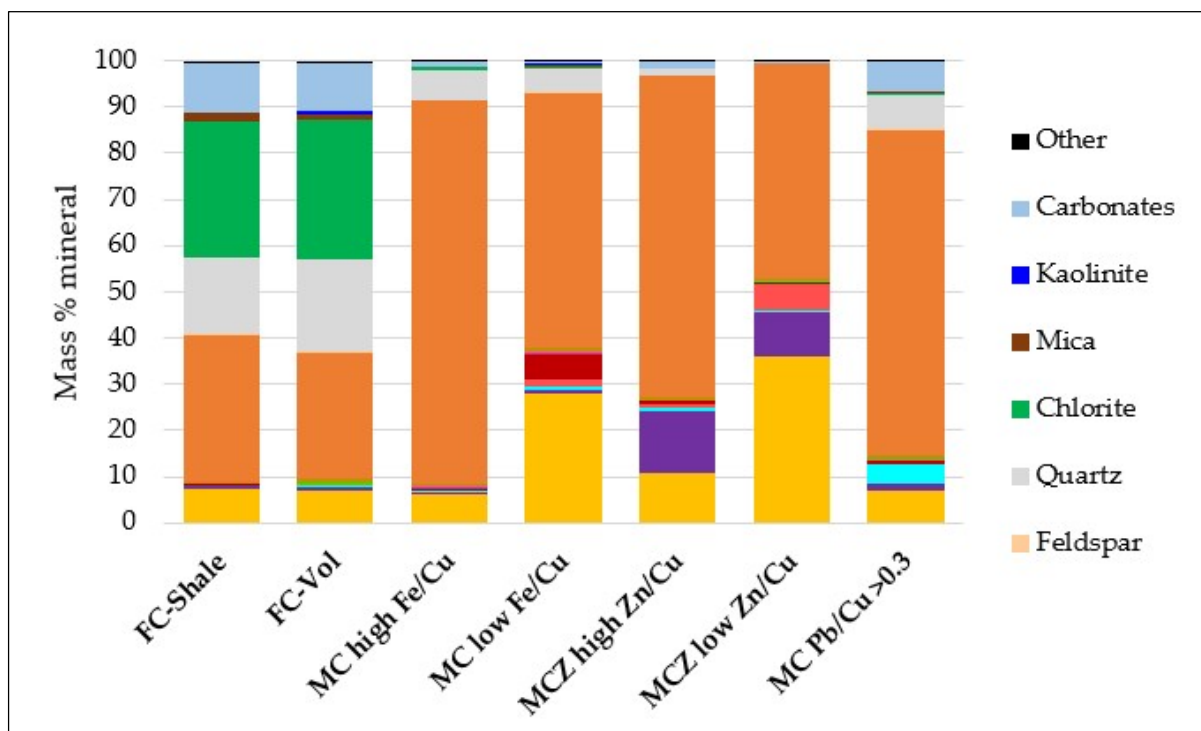

**Figure 13.1: Modal mineralogy for the Cu Geomet Composites**

The stockwork ores, FC-Shale and FC-Volcanics, show the lowest pyrite content. They also have very similar gangue mineralogy profiles dominated by quartz, chlorite and carbonates. The FC-Volcanics has arsenic-bearing mineralogy with elevated tetrahedrite, cobaltite and arsenopyrite compared to the FC-Shale.

The MC High and Low Fe/Cu composites have similar overall total sulphide contents. Although it would be expected that the higher Fe/Cu composite would have a higher As:Cu ratio, the overall arsenic sulphide mineralogy is higher in the MC Low Fe/Cu composite with elevated Cu sulphosalts (mainly tetrahedrite) and arsenopyrite.

Similar to the Fe/Cu ratio samples, the higher Zn/Cu ratio composite has a higher As:Cu ratio, however, the low Zn/Cu composites show higher overall sulphosalts (dominated by tennantite).

The Pb/Cu>0.3 composite shows high arsenic mineralogy with tetrahedrite and arsenopyrite.

The sulphosalt mineralogy shows that Zn-bearing tennantite is more abundant in MCZ ores whereas tetrahedrite is more common in the MC ores.

The mineralogy of the FC composites is closest to the previous mill feeds measured in plant Cu surveys in terms of pyrite content.

No secondary Cu minerals were identified in the composites.

The data suggests stockwork ores have higher chalcopyrite liberation and lower pyrite content. The pyrite to chalcopyrite ratio against the chalcopyrite liberation is shown in Figure 13.2.

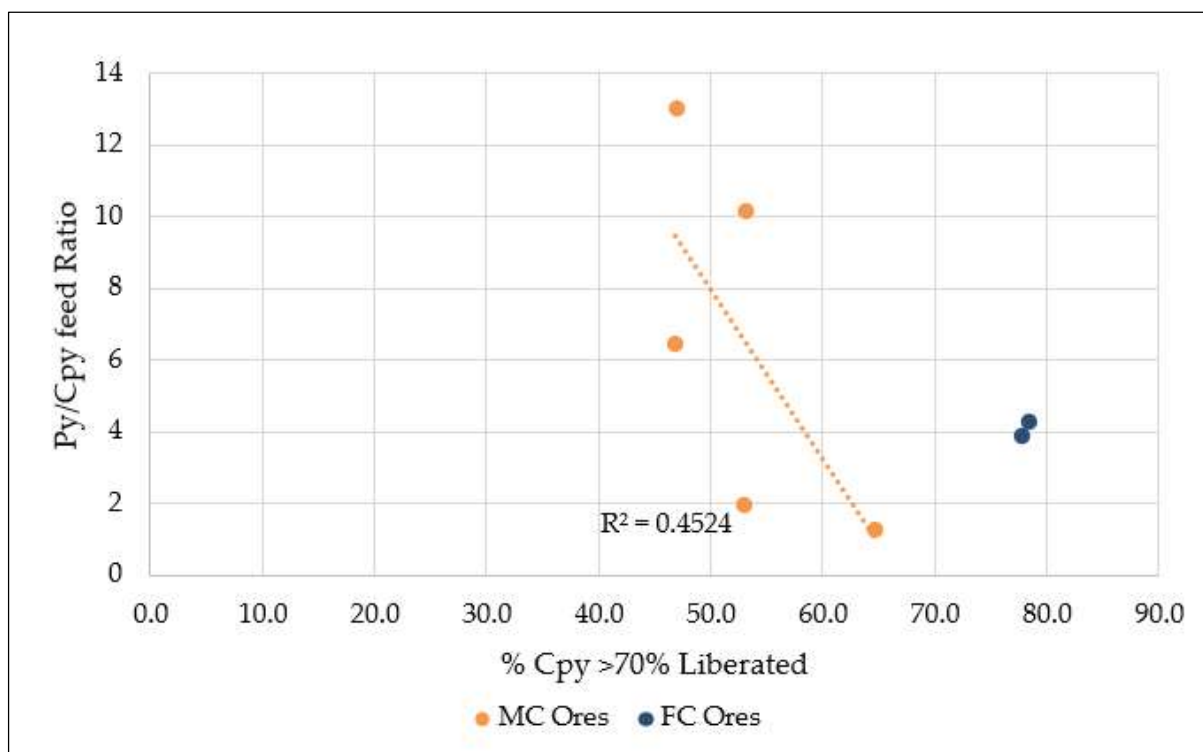

**Figure 13.2: Pyrite/Chalcopyrite Composite Ratio vs. Chalcopyrite Liberation**

This assumption of coarser grain size holds true for FC ores compared to MC ores. There is also an observed trend showing decreasing average chalcopyrite size with increased Py/Cpy ratio.

#### 13.1.4 Liberation

The liberation was assessed for each composite on an unsized basis for chalcopyrite, sphalerite, pyrite and galena. The stockwork ores showed the highest levels, with approximately 80% of chalcopyrite being >70% liberated. The volcanic and shale hosted ores show similar chalcopyrite liberation profiles. The MC ores show lower chalcopyrite liberation.

Pyrite liberation >70% is high for stockwork and MC high and low Fe/Cu composites, with the MC high and low Zn/Cu and MC Pb/Cu >0.3 composites showing a lower level of free, liberated and high-grade middling pyrite.

The MC ores show low sphalerite liberation with only 30-40% of sphalerite >70% liberated. The proportion of low-grade middlings and locked sphalerite varies between the MC composites.

Galena liberation is low for all composites with most occurring as locked or low-grade middlings.

The data is shown in Figure 13.3, Figure 13.4 and Figure 13.5.

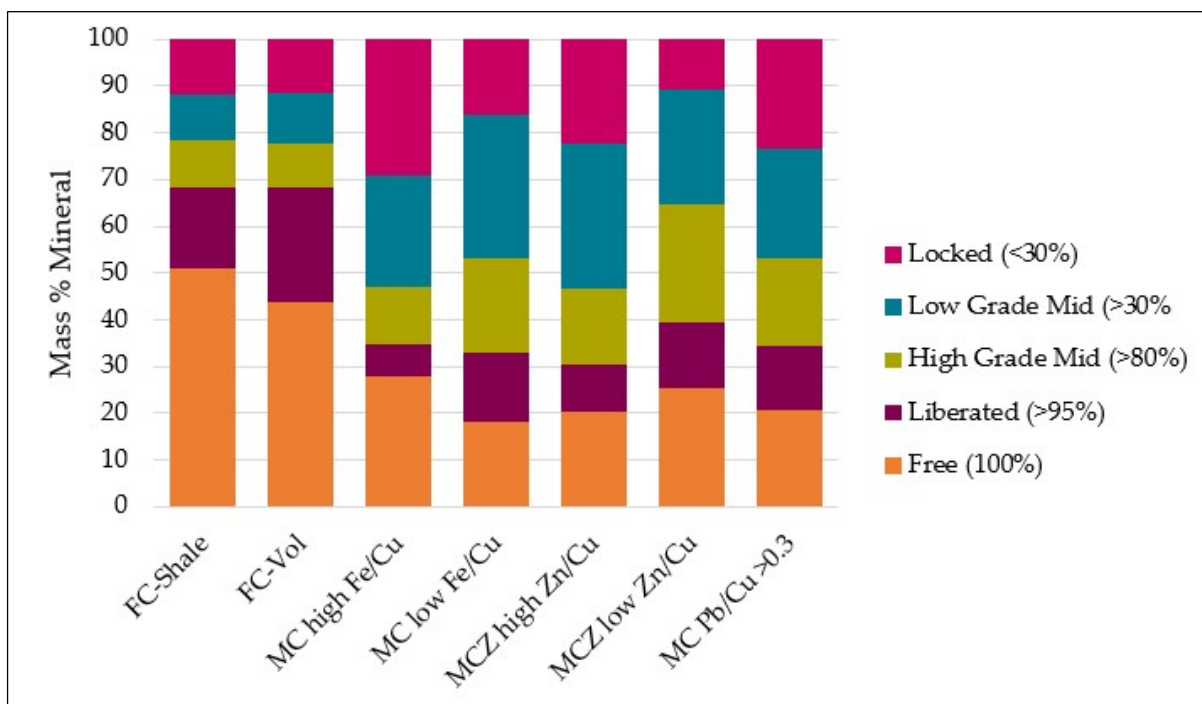

Figure 13.3 : Chalcopyrite Liberation Data

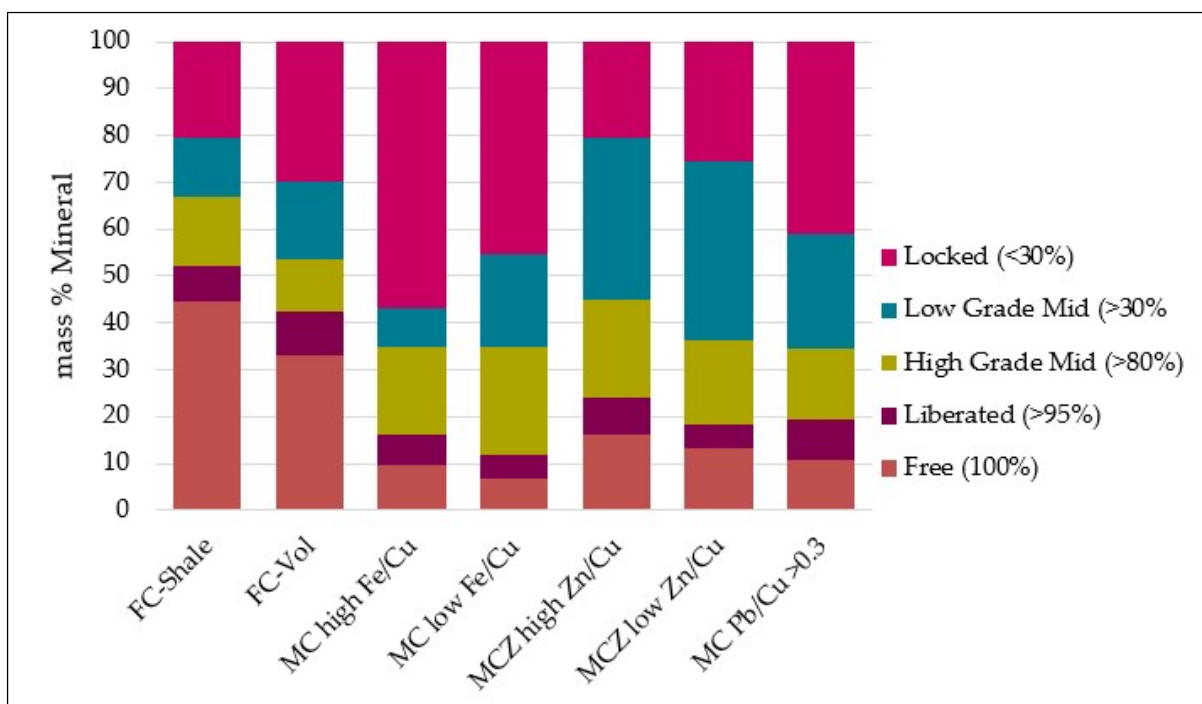

Figure 13.4 : Sphalerite Liberation Data

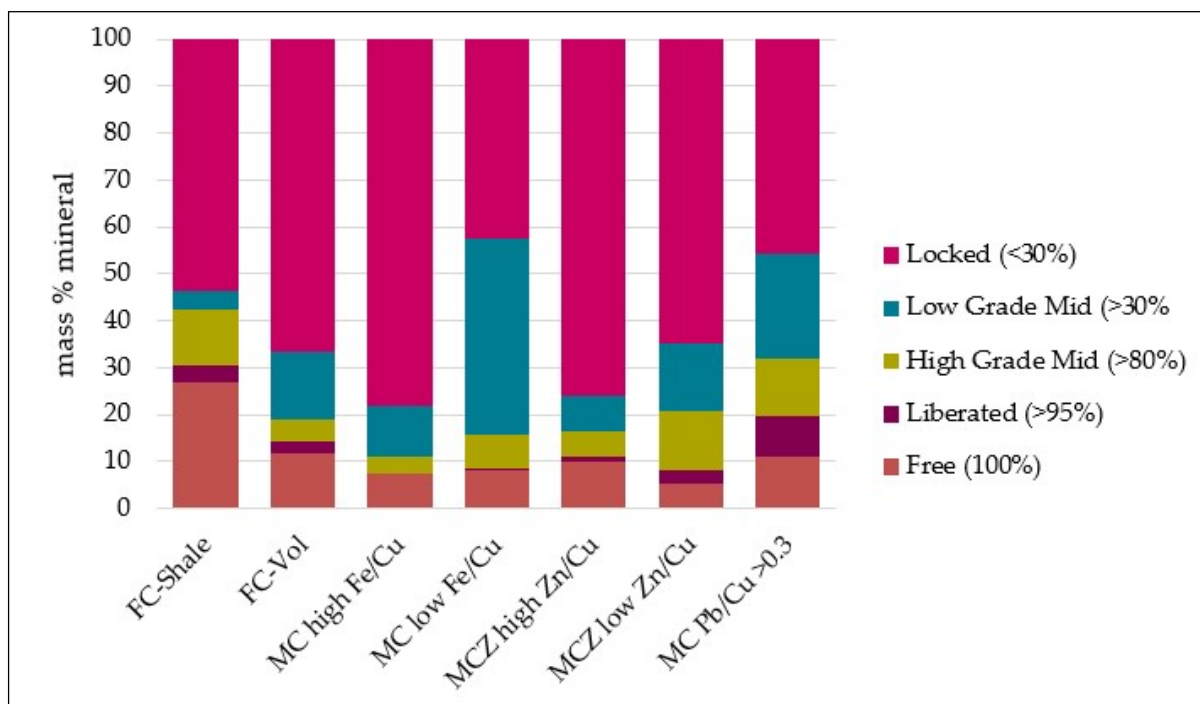

Figure 13.5 : Galena Liberation Data

### 13.1.5 Elemental Department

A number of Cu-bearing species are present in the ores: chalcopyrite, tennantite and tetrahedrite. Cu department to these phases may provide insight to impacts of this mineralogy on copper recovery.

Arsenic is another element raised as a potential proxy for changes in Cu recovery performance that also has a number of minerals to which it is deported – arsenopyrite, cobaltite, tennantite, tetrahedrite and pyrite.

The Cu department of Cu in each sample is shown in Figure 13.6.

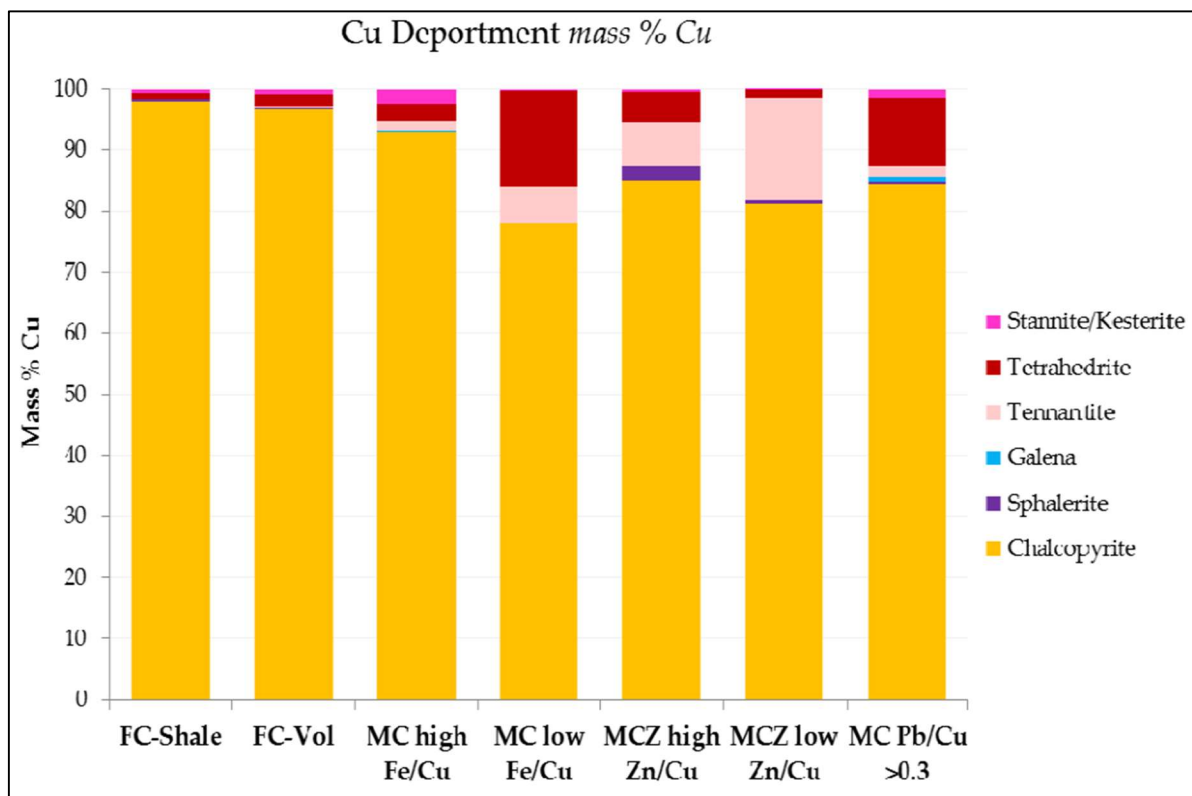
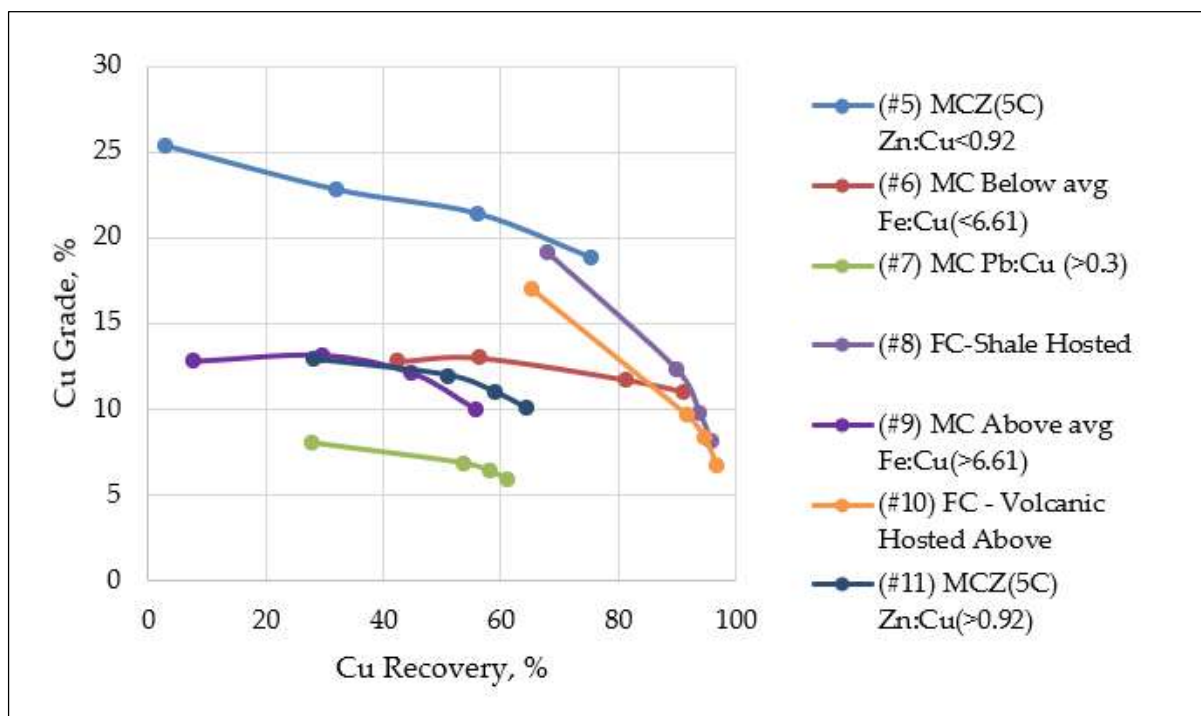

**Figure 13.6: Copper Mineral Department**

The Cu department is dominated by chalcopyrite. Sulphosalts (tennantite and tetrahedrite) are more prevalent in MC ores. Higher Cu grade composites (MC Fe/Cu Low and MCZ Zn/Cu Low) contain more sulphosalts by proportion than the lower grade equivalents. The ratio between tennantite and tetrahedrite also varies with tennantite being more prevalent in Zn rich composites.

### 13.1.6 Flotation Tests

A single flotation test was undertaken on each composite at a grind size stated as 80% <60 µm, 34% solids, pH 10.0 and with 20g/t SIPX per 1% Cu. The results are summarised in Figure 13.7.



**Figure 13.7: Copper Variability Samples Grade vs. Recovery**

The FC ores show the best Cu recovery to rougher concentrate, exceeding >95%. These ores also show an average of 75% Zn recovery to rougher concentrate and 65-72% Pb recovery to concentrate. Based on the Cu kinetic curves, both of these ores reach maximum recovery.

The MC ores show low Cu recovery (55.8%) for the high Fe/Cu and high Cu recovery (91.0%) for low Fe/Cu composites. Kinetics show that Cu recovery would continue with added retention time. The high Fe/Cu composite showed good selectivity of Cu against pyrite, Pb and Zn while the low Fe/Cu showed almost no selectivity.

The MCZ ores both showed lower Cu recovery between 64.4% and 75.3%. The low Zn/Cu ore had extremely high Cu rougher concentrate grade at 18.9% Cu. The Cu kinetics showed the high grade, low Zn/Cu composite would have increased Cu recovery with added retention time. The high Zn/Cu composite showed the Cu recovery was at completion with final recovery at ~65%. The selectivity of Cu against pyrite in these ores was similar, while the selectivity against Zn was better in the high Zn/Cu composite over the low Zn/Cu composite.

The MC high Pb/Cu composite showed the worst grade recovery performance reaching only 60.9% Cu recovery. The kinetics also show that under these conditions, the Cu recovery has reached a maximum.

Selectivity between Cu and Zn, Pb or pyrite is consistent with the other ores and very close to the MCZ high Zn/Cu composite.

### **13.1.7 Conclusions**

The following conclusions are made regarding the composites selected for the copper ore Geomet program:

- The FC shale-hosted and volcanic ores show similar gangue mineralogy, indicative ore hardness and excellent Cu rougher recovery:
  - The gangue mineralogy does not include species expected to have negative impacts on flotation;
  - Cu recovery is 95-97% to rougher concentrate for both ores;
  - Chalcopyrite grain size and liberation are high for both ores;
  - Cu deportment to minerals other than chalcopyrite is low at <4%;
  - Selectivity of Cu against pyrite in flotation is good and matches that previously observed in Cu circuit surveys completed by XPS.
  
- The MC/MCZ ores show similar properties to one another and, from this dataset, overall pyrite feed grade and arsenic feed grade are shown to drive Cu recovery, Cu/pyrite selectivity, Zn and potentially Pb recovery and Cu deportment:
  - The observed trends in a previous Geomet sample review showing lower chalcopyrite liberation with higher feed Py/Cpy ratio holds true. The proportion of locked chalcopyrite shows a better trend. This is also correlated with lower chalcopyrite grain size with increasing Py/Cpy ratio. The pyrite feed grade and to a lesser extent Fe feed grade, shows a stronger relationship than Py/Cpy feed ratio.
  - A lower proportion of Cu is deported to chalcopyrite with lower pyrite feed grade. Additional Cu species are dominated by sulphosalts, tennantite and tetrahedrite. No secondary or oxide Cu species were identified. The ratio of tetrahedrite over tennantite is higher in MC ores. The more Zn rich zones, MCZ, show preference to tennantite.
  - In this dataset, As grade above approximately 0.5% shows increasing sulphosalt mineralogy in combination with arsenopyrite. Below 0.5% As, arsenopyrite is the dominant As mineral. As head grade also shows a relationship that increases with decreasing pyrite.

## **13.2 XPS Zinc Geomet Testwork (2018)**

### **13.2.1 Samples Submitted and Head Analysis**

The program tested seven composites representing spatially cohesive and meaningful volumes of ore. The samples submitted and their head grades are shown in Table 13.2.



Table 13.2: Zinc Variability Test Head Grades								
Orebody	Ore Type	Assay						
		Cu (%)	Pb (%)	Zn (%)	Fe (%)	S (%)	As (%)	Si (%)
Corvo	MZ	0.45	1.77	8.72	35.5	44.5	1.01	1.18
Graca	MZ	0.35	0.41	9.11	36.5	47.3	0.68	0.65
Lombador	MZ	0.38	0.72	7.01	35.0	41.9	0.76	0.68
Neves	MZ	0.32	2.14	7.96	33.6	43.5	0.63	0.38
Zambujal	MZ	0.26	2.67	9.36	34.5	44.9	0.48	0.40
Corvo	MZP	0.374	1.04	6.33	38.7	47.1	0.45	0.55
Lombador	MZP	0.32	0.39	8.04	36.7	47.3	0.43	1.33

The copper grades did not vary significantly, ranging from 0.26 to 0.45% Cu whereas the lead grades ranged from 0.39% to 2.67%. The zinc grades ranged from 6.33% to 9.3% Zn which are in reasonable agreement with the normal Zinc Plant feed grades.

### 13.2.2 Bond Work Index Test

The Bond ball mill work indices for the seven composites ranged from 11.2 to 12.2 kWh/t. This data is summarised in Table 13.3.

Table 13.3: Bond Ball Mill Work Index Results (kWh/t)	
MZ Corvo	11.2
MZ Graca	11.7
MZ Lombador	11.6
MZ Neves	12.0
MZ Zambujal	12.2
MZP Corvo	11.4
MZP Lombador	11.9

All of the seven composites fell in the “soft” range of hardness. Sample MZP Corvo was the hardest and overall was classified as “moderately soft”. The closing size for the tests was selected as 53µm.

### 13.2.3 Zinc Mineralogy

#### 13.2.3.1 Introduction

Mineralogical analysis was completed using QEMSCAN. Sub-samples extracted from confirmation grinds at the P80 target of 60µm were used for the mineralogical analysis. Each sample was deslimed to remove -3µm material.

#### 13.2.3.2 Modal Mineralogy

The modal mineralogy of the seven composites is shown in Figure 13.8.

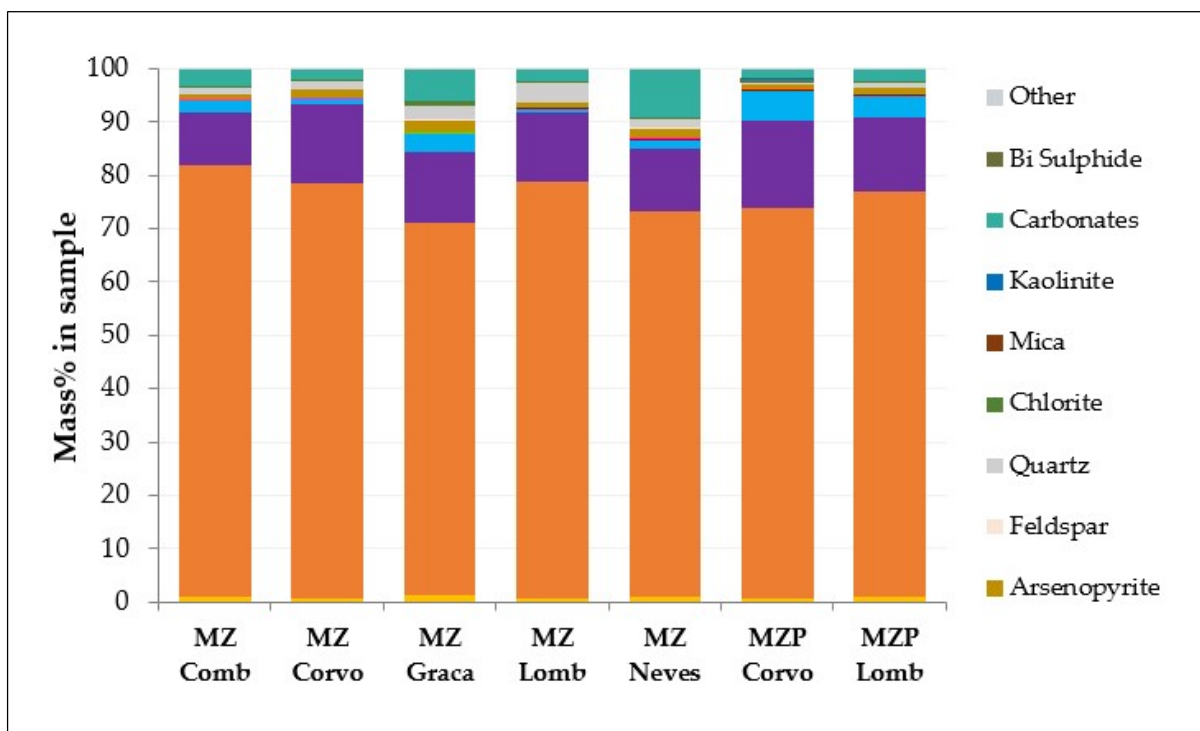

**Figure 13.8: Modal Mineralogy for the Zn Variability Composites**

The mineralogy between the seven zone composites is similar. Variations are mostly in gangue content (between 3-12%), driven by quartz and carbonates, as well as variations in galena content. Sphalerite content varies between 10-16%.

Arsenic is present mainly as arsenopyrite with very little Cu sulphosalts. Where sulphosalts are present, these are dominated by tetrahedrite. No secondary Cu minerals were identified in the composites.

### 13.2.3.3 Mineral Grain Size

Tabled average grain size data is shown in Figure 13.9.

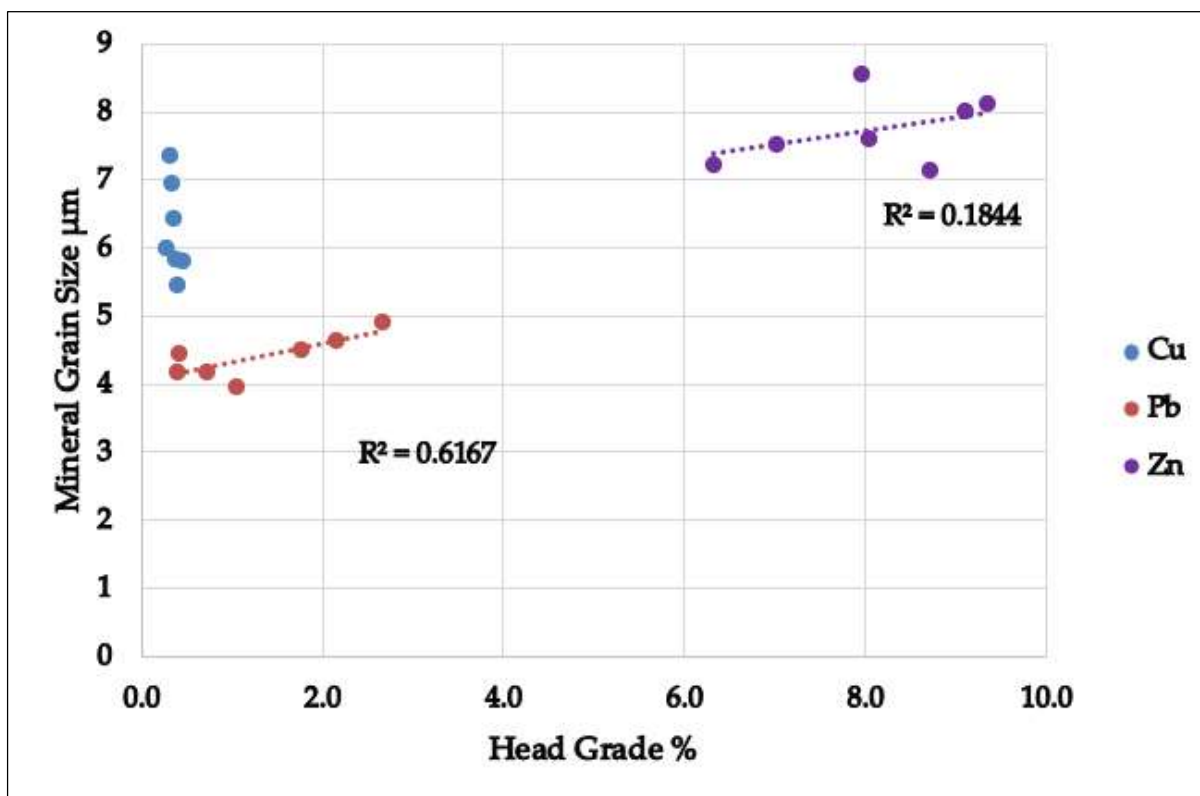

Figure 13.9: Head Grade vs. Measured Average Mineral Grain Size

Mineral ratios do not show any relationship to grain size, as was observed for the Cu samples. Galena is the only mineral that increases in grain size with head grade. A weak relationship is observed for sphalerite.

### 13.2.4 Liberation

Liberation was assessed for each composite on an unsized basis for chalcopyrite, sphalerite, pyrite and galena. Figure 13.10, Figure 13.11 and Figure 13.12 show the liberation data for chalcopyrite, sphalerite and galena.

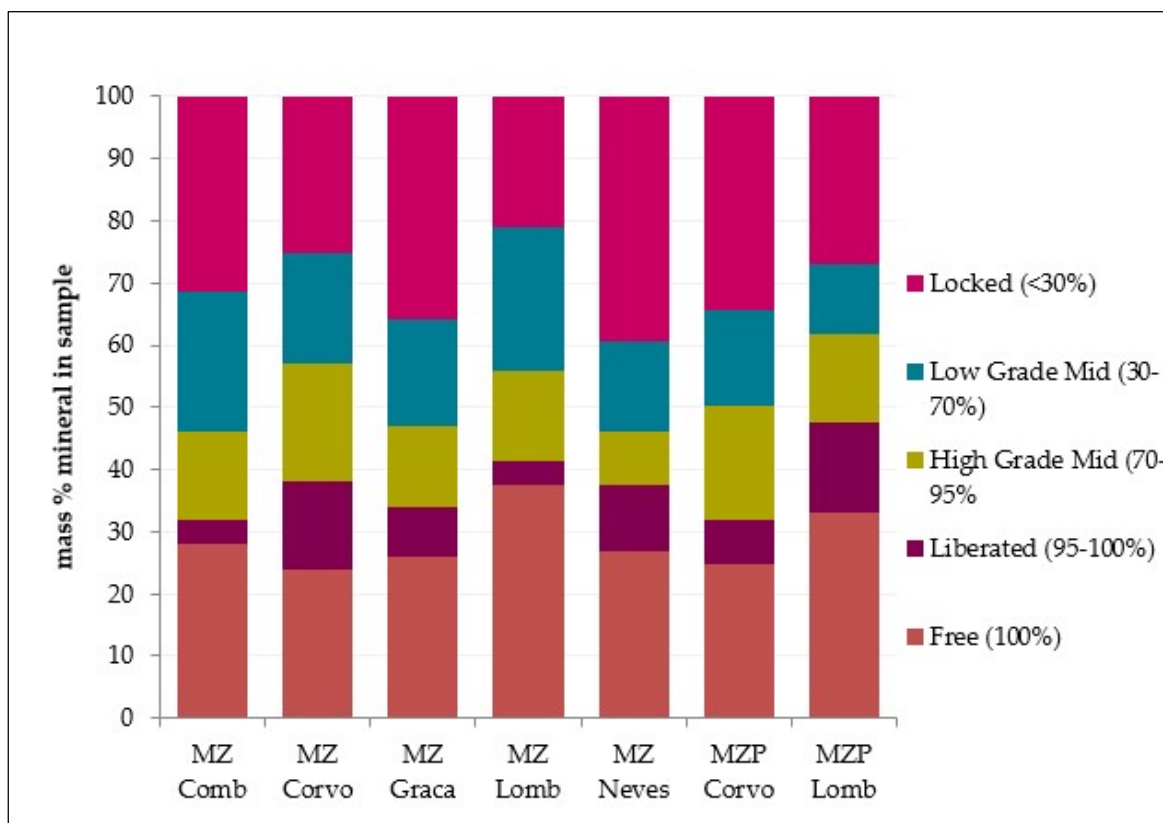

Figure 13.10 : Zn Geomet Composite Liberation Data – Chalcopyrite

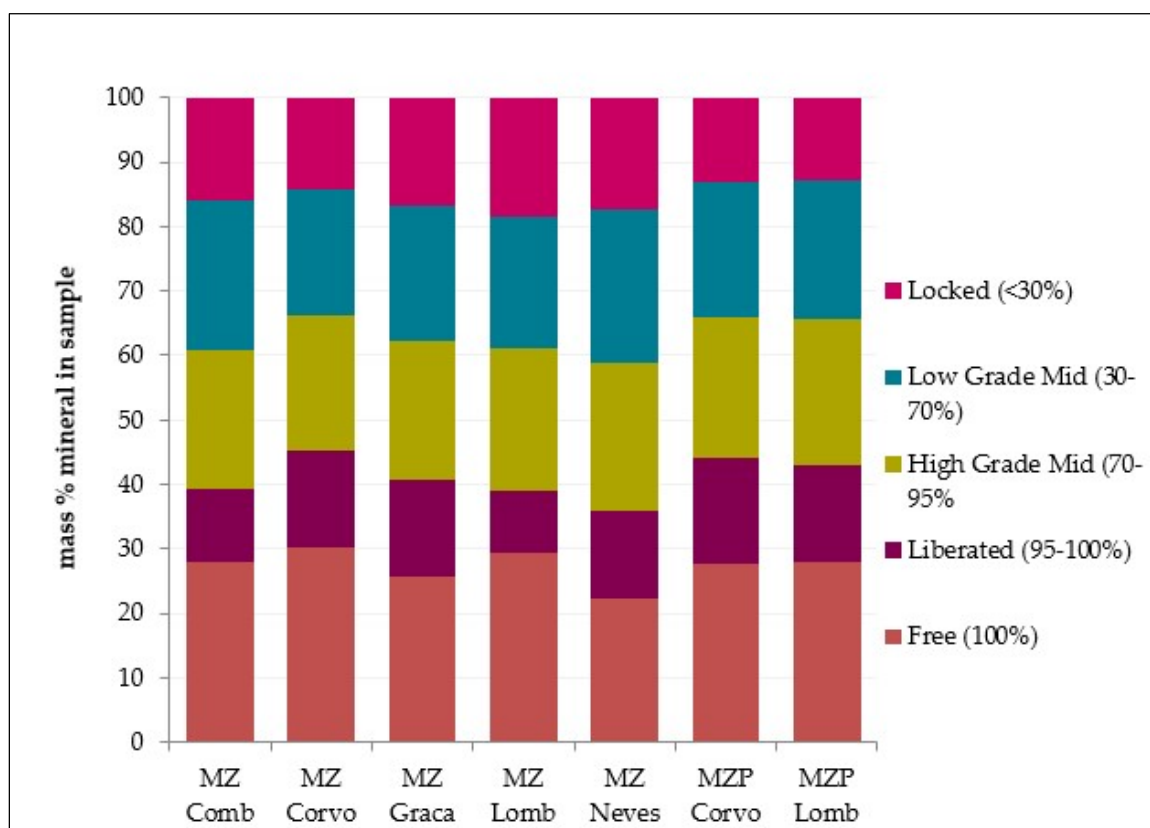
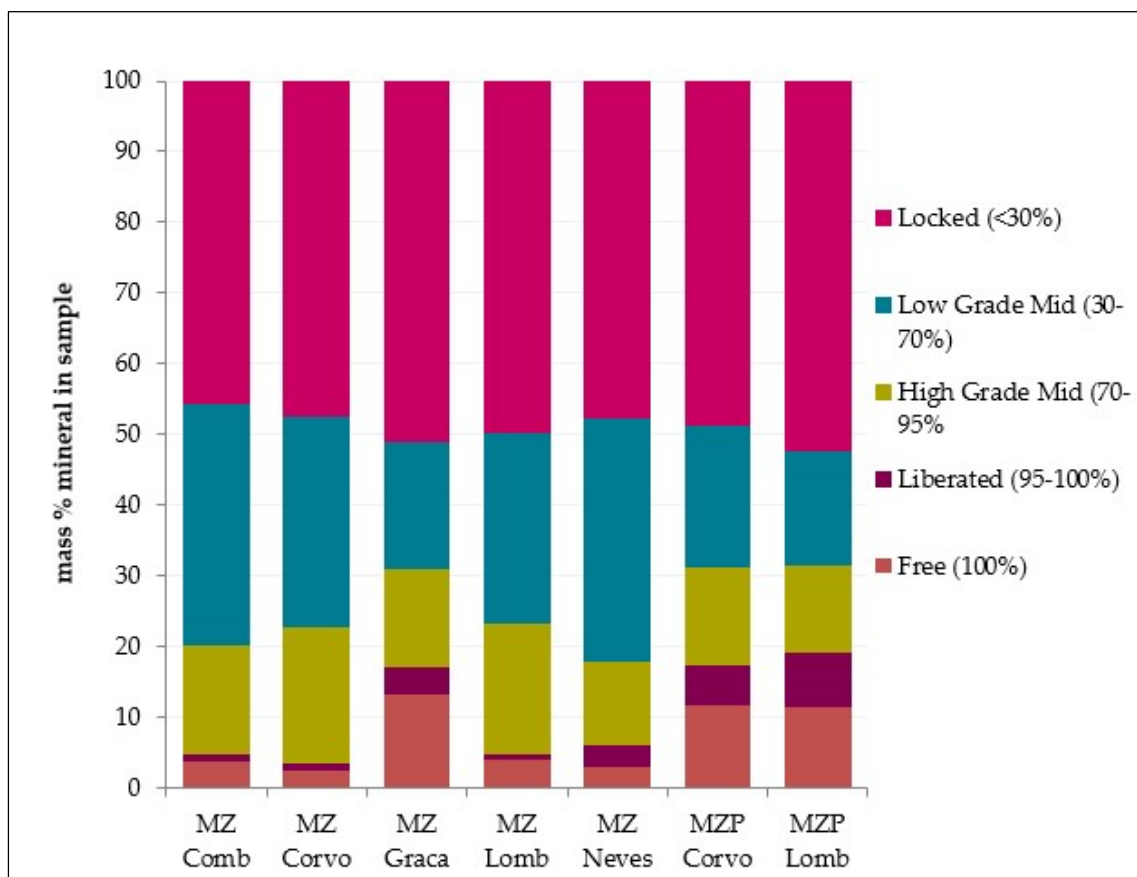

Figure 13.11 : Zn Geomet Composite Liberation Data - Sphalerite



**Figure 13.12 : Zn Geomet Composite Liberation Data - Galena**

Liberation is very similar between all composites. Chalcopyrite liberation is highest in both Lombador composites and MZ Corvo. An average of 52% of the mass of chalcopyrite is >70% liberated for the seven composites and ranges from 46% to 62%.

Galena liberation is low for all composites, with most occurring as locked or low-grade middlings. The MZP ores with high Pb grade show higher liberation as does MZ Graca. A similar trend is observed with the increase in average galena grain size which is likely a factor of grade. The average size of locked galena is 4-5µm. An average of only 25% of the mass of galena is >70% liberated for the seven composites with a range from 17% to 32%.

Sphalerite liberation is very consistent between all samples, averaging 63% of sphalerite >70% liberated for the seven samples with a narrow range of 58-66%.

Figure 13.13 shows the trend of >70% liberation for sphalerite, chalcopyrite, pyrite and galena for each of the composites.

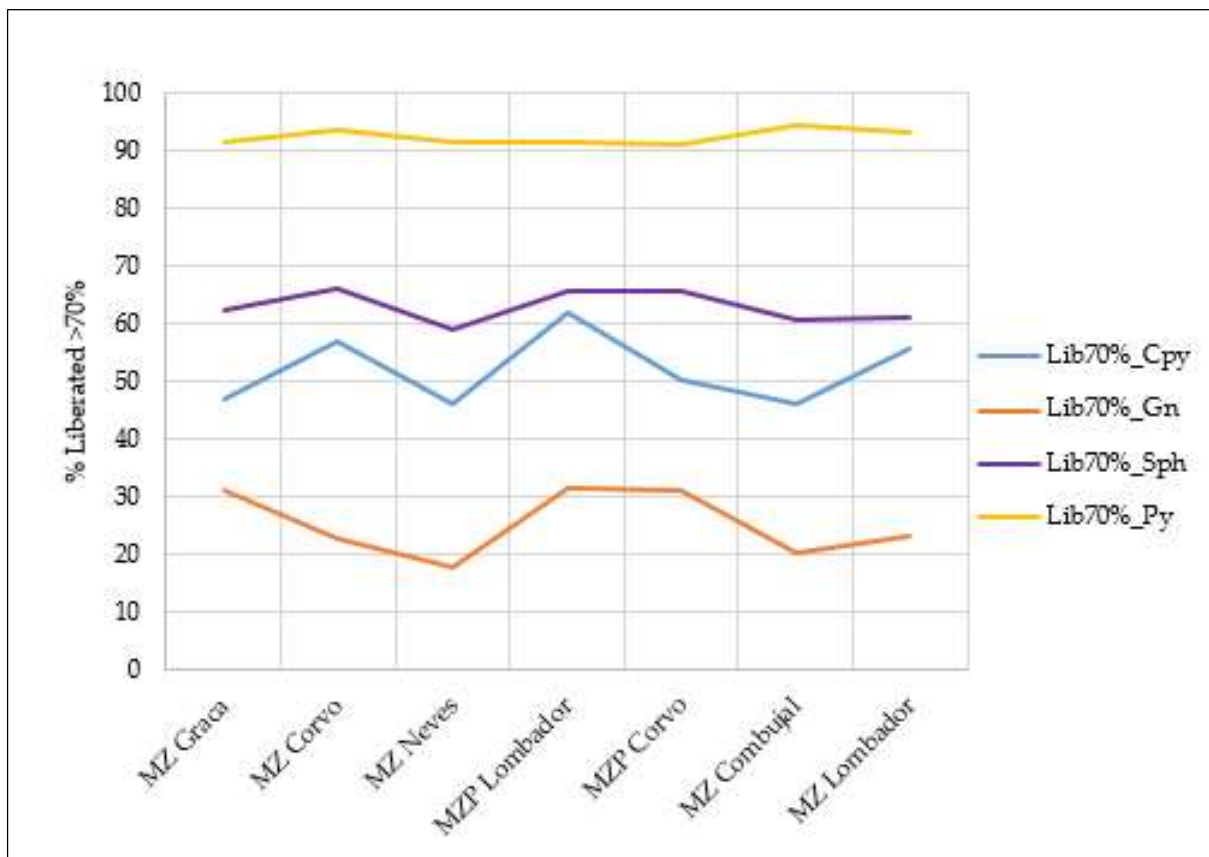

Figure 13.13: Mass % Mineral >70% Liberated for all Composites

### 13.2.5 Rougher Flotation Tests

All seven composites were subjected to single flotation tests using SOMINCOR's supplied conditions for laboratory testwork with the only adjustment being to collector dosed for head grade. These conditions are not necessarily similar to the reality in the plant. Figure 13.14, Figure 13.15 and Figure 13.16 show a summarised cumulative grade and distribution for the seven composites.

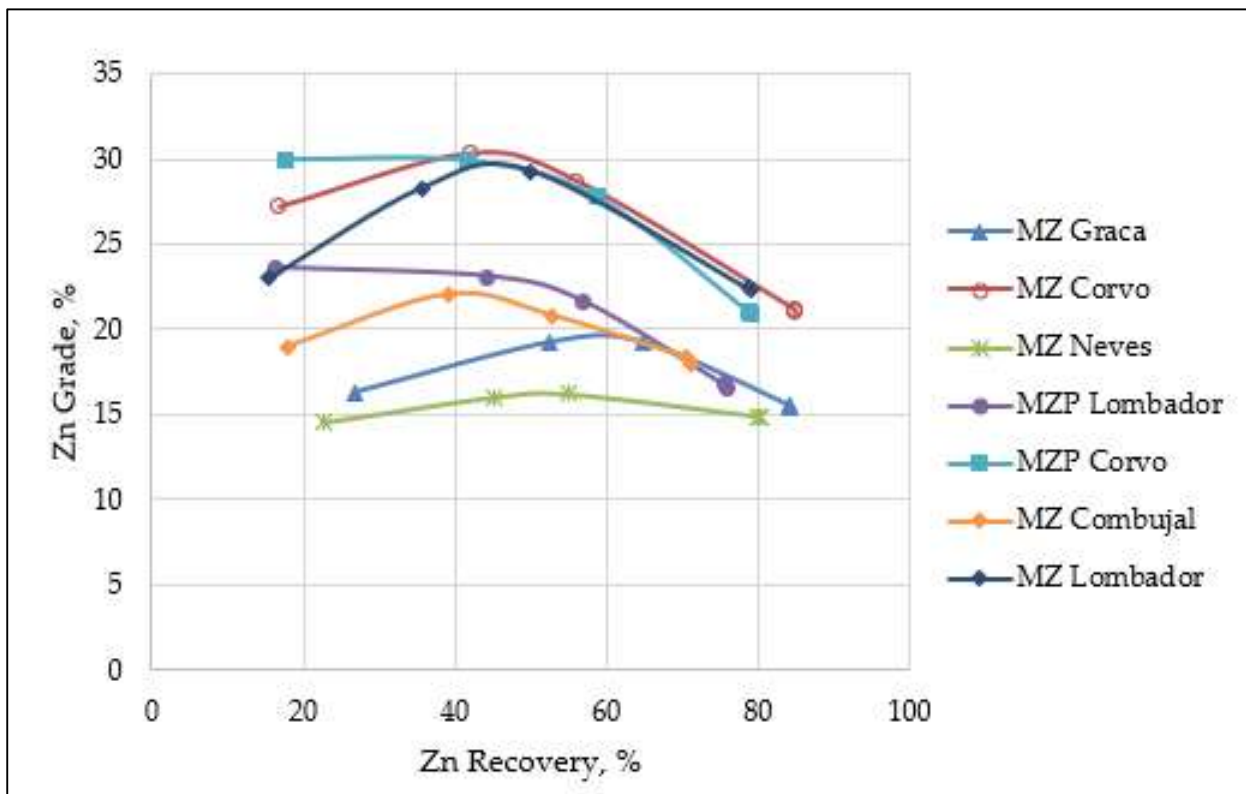

Figure 13.14 : Zn Geomet Flotation Grade vs. Recovery Curve – Zinc

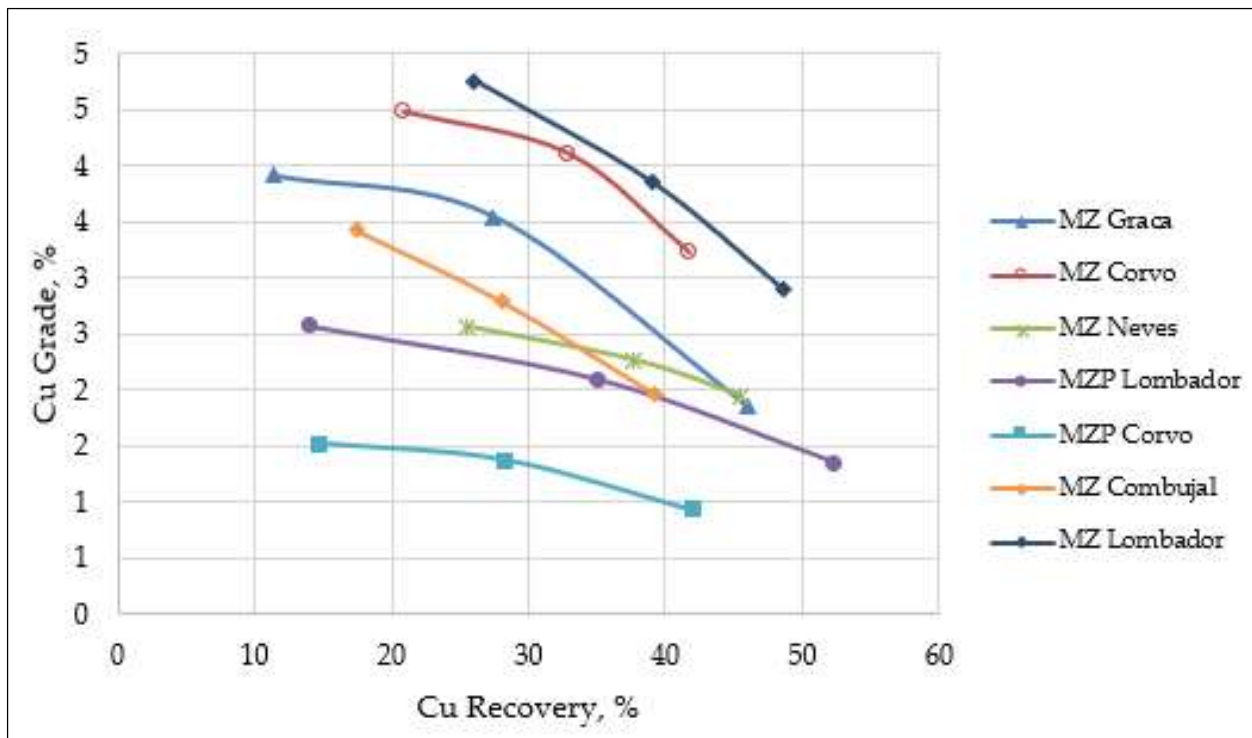
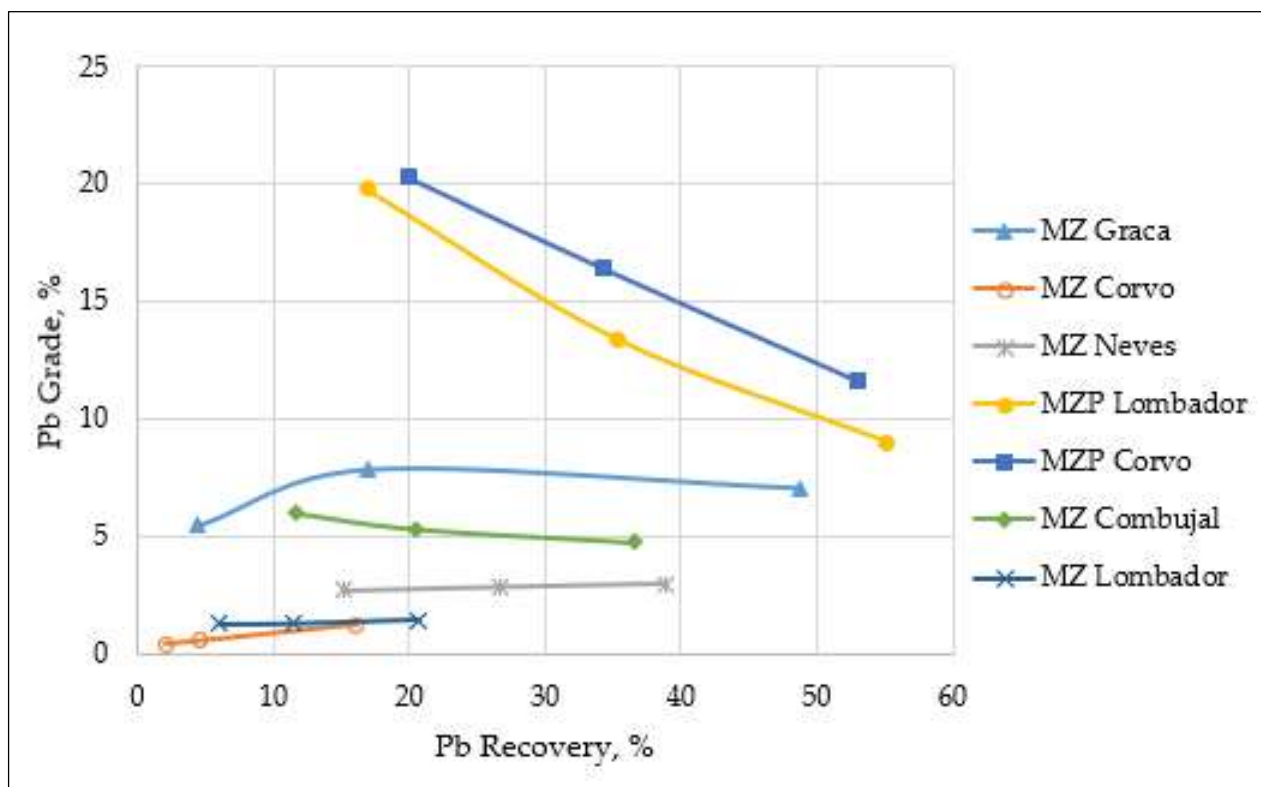

Figure 13.15 : Zn Geomet Flotation Grade vs. Recovery Curve - Copper



**Figure 13.16 : Zn Geomet Flotation Grade vs. Recovery Curve - Lead**

The MZP ores clearly show the better Pb grade and recovery response, both corresponding to high Pb feeds. The poorest response is from MZ Corvo and MZ Lombador corresponding with 0.4% Pb head grades. Kinetics for MZ Graca show a steep kinetic curve with very slow initial kinetics. Pb selectivity against Zn in the Pb rougher shows similar curves for all samples.

Cu grade and recovery response is best in both MZ Corvo and MZ Lombador ores. There are no factors easily distinguishable for these ores that would explain an improved flotation response.

Similarly, the best Zn response is also from the MZ Corvo and MZ Lombador ores as well as MZP Corvo. However, this sample has the advantage of a higher head grade but also gave a higher rougher tails grade. Zn rougher recovery does not show large differences between the ore. Differences in rougher concentrate grade are more significant for the circuit. In fact, the MZ Corvo, MZ Lombador, MZ Zambujal and MZ Graca show a lower Zn concentrate grade for the first rougher concentrate increment, corresponding with a spike in pyrite flotation. MZ Graca and MZ Neves show the worst selectivity of Zn against pyrite corresponding to slightly lower pyrite measured in the feeds.

### 13.3 Conclusions

The following conclusions are made regarding the composites selected for the Zn Geomet program:



- The MZ ores show a strong recovery relationship with Fe:Zn ratio in the feed. Fe as an indicator for pyrite content shows that a higher ratio of Fe to Zn in the feed can significantly reduce Zn recovery to Zn rougher concentrate;
- Rougher recovery of Zn and Pb increases with increasing head grade for MZ ores. Cu does not show this relationship;
- Liberation of sphalerite is very consistent between the ore zones and shows weak relationships to head grade or recovery;
- Arsenic department or Cu sulphosalt content is not significant in the Zn ores and shows no significant relationship to either Zn, Cu or Pb recovery. Arsenic content does increase with decreasing pyrite content;
- Zn rougher concentrate grade is different in the ores and relates to pyrite selectivity. A relationship between pyrite/carbonate ratio vs Zn rougher concentrate grade is observed but not clearly understood as to its impact on Zn/pyrite selectivity;
- Some pyrite shows fast recovery in the beginning of the Zn rougher circuit showing low to increasing Zn grade in the cumulative grade/recovery curves;
- Galena liberation is low in MZ ores but increases in MZP ores and MZ Graça, with higher head grades. This improvement is only from low 20% (average) liberation to 30% (average) liberation;
- Only two samples represented MZP ores. Pb recovery to rougher concentrate is higher in MZP than MZ ores;
- Pb recovery does show relationship of increasing Pb rougher recovery with high Pb:Zn ratios, higher Pb head grade and higher Pb:Cu ratios when comparing all MZ and MZP ores together.

#### 13.4 WAI Testwork (2019)

SOMINCOR commissioned WAI to undertake a programme of variability testing on copper ores. The testing focussed on two primary composite and four secondary composite samples which reflect the ore reserves for the Neves-Corvo Mine.

The samples forming the primary composites (MC and FC) originated from the Lombador Phase 1, Corvo, Zambujal, Neves, Graça, and Lombador Phase 2 (North & South) ore types.

The secondary composites were: Neves MC, Neves North FC and Lombador Massive Phases 1 and 2.

The testwork, carried out at grind size of 80% <  $\pm 65 \mu\text{m}$ , demonstrated the considerable differences that exist in the flotation properties of the SOMINCOR ore types. The plant treats a mixture of the MC and FC ore types and it is known that the FC ores are coarser grained and due to their lower pyrite content give significantly better flotation response than the MC ores.

The results of the locked cycle tests undertaken on the primary and secondary composites are shown in Table 13.4.

Composite	Copper Concentrate Grade							Cu Recovery (%)
	Cu (%)	Pb (%)	Zn (%)	Ag (%)	Sb (%)	As (%)	Hg (ppm)	
Primary MC	16.7	1.09	4.91	337	0.43	0.23	105	53.5
Primary FC	24.2	0.49	3.21	128	0.12	0.13	45	86.3
MC Neves	23.7	0.46	0.67	473	0.48	0.19	39	71.8
FC Neves	26.5	0.72	2.34	167	0.07	0.10	32	94.1
MC Lombador Ph. 1	20.8	0.13	0.32	98	0.54	0.25	39	47.1
MC Lombador Ph. 2	17.2	0.44	4.23	407	0.42	0.20	76	67.6

The massive samples give generally poor results with concentrates grading 16.7% Cu to 23.7% Cu at recoveries of between 47.1% and 71.8%.

In contrast, the FC composites gave concentrates grading 24.2% Cu and 26.5% Cu at recoveries of 86.3% and 94.1%.

The poor metallurgical performance of the massive ores is likely due to the poorer liberation characteristics compared with previous copper ores tested by WAI. A comparison with previous SOMINCOR copper ores tested by WAI indicated that the chalcopyrite is finer grained. In addition, the previous WAI testwork was undertaken at a d80 of 50µm rather than the 65µm used in this testwork programme. The secondary composites of Lombador Phase 1 and 2 samples proved difficult to grind due to the nature of the pulp with high viscosities and a tendency for the ground material to coat the rods. The metallurgical performance in these tests did not significantly deteriorate when compared with the results from the primary MC sample.

It is likely that when treated as a MC/FC blend the MC component of the plant feed does experience some syngenetic effect of being ground to a finer size by the harder FC component and therefore further testwork on MC/FC blends was recommended.

As part of the study, SOMINCOR also commissioned WAI to carry out a comminution study on the future underground mine feedstocks. The results of an empirical Excel modelling study indicate that the design production rate of 340t/h (both lines) is achievable at a predicted P80 of 75µm. Reducing the plant throughput rate by 10% to 306t/h (both lines) results in a slightly finer grind size of 80% passing 70µm reporting to the flotation circuit.

When comparing the rod and ball mill work index results with those obtained previously (2013), in the 2019 tests the FC primary composite rod mill work index was 14.9 versus the 2013 average of 16.1 and the FC primary ball mill work index was 14.8 versus the 2013 average of 15.0.

In the 2019 tests the MC primary composite rod mill work index was 15.5 versus the 2013 value of 15.0 and the MC primary ball mill work index was 12.2 versus the 2013 average of 11.8.

### **13.5 Conclusions**

The testwork has confirmed the considerable differences between the copper recoveries that will be achieved with the massive and stockwork ore types. Tests by WAI on the massive ore types show final copper recoveries from 53.5% to 71.8%. The XPS tests gave copper rougher recoveries ranging from 55.8% to 91.0% with an average rougher recovery of 69.5%. The average back calculated head grade of the massive samples was 6.5% Cu which is substantially higher than current production and testing of more representative samples would likely result in even lower recoveries.

For the WAI tests the poor metallurgical performance of the massive ores was attributed to the poorer liberation characteristics compared with previous copper ores tested at WAI. A comparison with previous SOMINCOR copper ores tested by WAI indicated that the chalcopyrite is finer grained.

In contrast, the FC ore type gave an excellent metallurgical response at both laboratories. The XPS tests gave rougher recoveries of 95.7% and 96.7% indicating that final recoveries would be in excess of 90%. The tests by WAI gave copper recoveries of 86.3% and 94.1% to the final concentrate.

### **13.6 Adequacy of Testwork**

The metallurgical sample selection was undertaken by competent personnel following a detailed geometallurgical review of the various orebodies using procedures that are consistent with industry best practices. The authors conclude that the orebodies tested are representative of future ore sources and that the testing was contracted to competent and experienced laboratories. The testwork indicated that levels of impurities in the concentrates were similar to those achieved historically by the operation.

## **14 MINERAL RESOURCE ESTIMATE**

### **14.1 Introduction**

The Mineral Resource estimates discussed in this Technical Report are located within the integrated Neves-Corvo Mining Concession and include the following deposits: Neves, Corvo, Graça, Zambujal, Lombador, Monte Branco and Semblana. All Mineral Resource estimates were reviewed by the authors.

### **14.2 Mineral Resource Estimate Data**

Data used for Mineral Resource estimation included underground face samples and diamond core drilling (surface and underground). The cut-off dates for these databases are detailed in Section 12.2. The databases were provided to the authors in Microsoft® Excel format for review.

#### **14.2.1 Software**

Database import and preparation, compositing, block modelling and grade estimation were undertaken using Vulcan® software. Wireframe modelling of mineralised envelopes was undertaken using Vulcan 3D® and Leapfrog Geo® software. Statistical and variographic analysis were undertaken using Supervisor® software. Data used in the Mineral Resource estimates were reviewed by the authors using Datamine® and Supervisor® software.

#### **14.2.2 Data Validation**

The database was reviewed by the authors and included the following checks. An evaluation of minimum and maximum grade values and sample lengths, assessing for inconsistencies in spelling or coding (typographic or case sensitive errors), ensuring full data entry and that a specific data type (collar, survey, lithology and assay) is not missing, assessing for sample gaps and overlaps and a review of assay detection limits and identification of problematic assay records. A spatial on-screen review of the grade and lithology distributions of drillholes and face samples was undertaken to identify any exhibiting data reliability issues. Overall, the databases were considered by the authors to be robust with no significant errors identified. A check on collar locations relative to underground workings and topography found only minor errors.

Problematic assay values were reviewed and updated prior to resource modelling. Assay values recorded as exactly zero were replaced by half detection limit. Assay values below the limit of detection were replaced with the detection limit value, with the exception of the deleterious elements (As, Hg, Pb and Sb) for which the laboratory reported values were retained. A correction factor is applied to reduce the Cu grades in face samples taken from the copper stockwork zones. This correction is applied on a deposit-by-deposit basis using comparison with drillhole data and is further described in Section 12.1.

A summary of the drillhole and face sample databases used in the Mineral Resource estimates is shown in Table 14.1. The database for Ag comprises only approximately 20% of the total assays because historically Ag was less comprehensively assayed. Areas of historical drilling and face sampling generally coincide with areas in which the resource has since been depleted by mining operations. All recent drilling includes comprehensive assaying including Ag.

Deposit	Type	Number of Drillholes / Face Samples	Number of Cu Assays	Number of Zn Assays	Number of Pb Assays	Number of Ag Assays
Neves	Surface Drillholes	148	6,527	6,527	6,527	2,668
	Underground Drillholes	3,586	175,449	175,449	175,449	52,662
	Face Samples	90,901	90,901	90,901	90,901	3,588
	<b>Sub Total</b>	<b>94,635</b>	<b>272,877</b>	<b>272,877</b>	<b>272,877</b>	<b>58,918</b>
Corvo	Surface Drillholes	86	3,347	3,347	3,347	1,174
	Underground Drillholes	2,260	81,630	81,630	81,630	21,805
	Face Samples	146,346	146,346	146,346	146,346	11,807
	<b>Sub Total</b>	<b>148,692</b>	<b>231,323</b>	<b>231,323</b>	<b>231,323</b>	<b>34,786</b>
Graça	Surface Drillholes	89	2,239	2,239	2,239	1,672
	Underground Drillholes	767	18,529	18,529	18,529	5,596
	Face Samples	66,690	66,690	66,690	66,690	7,017
	<b>Sub Total</b>	<b>67,546</b>	<b>87,458</b>	<b>87,458</b>	<b>87,458</b>	<b>14,285</b>
Zambujal	Surface Drillholes	59	4,008	4,008	4,008	1,972
	Underground Drillholes	1,045	65,521	65,521	65,521	18,443
	Face Samples	24,404	24,404	24,404	24,404	633
	<b>Sub Total</b>	<b>25,508</b>	<b>93,933</b>	<b>93,933</b>	<b>93,933</b>	<b>21,048</b>
Lombador	Surface Drillholes	178	15,536	15,536	15,536	5,552
	Underground Drillholes	1,253	86,975	86,975	86,975	24,411
	Face Samples	20,714	20,714	20,714	20,714	1,398
	<b>Sub Total</b>	<b>22,145</b>	<b>123,225</b>	<b>123,225</b>	<b>123,225</b>	<b>31,361</b>
Monte Branco	Surface Drillholes	126	4,334	4,334	4,334	3,151
	Underground Drillholes	-	-	-	-	-
	Face Samples	-	-	-	-	-
	<b>Sub Total</b>	<b>126</b>	<b>4,334</b>	<b>4,334</b>	<b>4,334</b>	<b>3,151</b>
Semblana	Surface Drillholes	151	5,118	5,118	5,118	3,835
	Underground Drillholes	-	-	-	-	-
	Face Samples	-	-	-	-	-
	<b>Sub Total</b>	<b>151</b>	<b>5,118</b>	<b>5,118</b>	<b>5,118</b>	<b>3,835</b>
<b>Grand Total</b>		<b>358,803</b>	<b>818,268</b>	<b>818,268</b>	<b>818,268</b>	<b>167,384</b>

Isometric views showing the drillholes and face samples at Neves-Corvo (not including Monte Branco or Semblana) are shown in Figure 14.1 along with underground development.

**a) Underground drillholes at Neves-Corvo Mine**

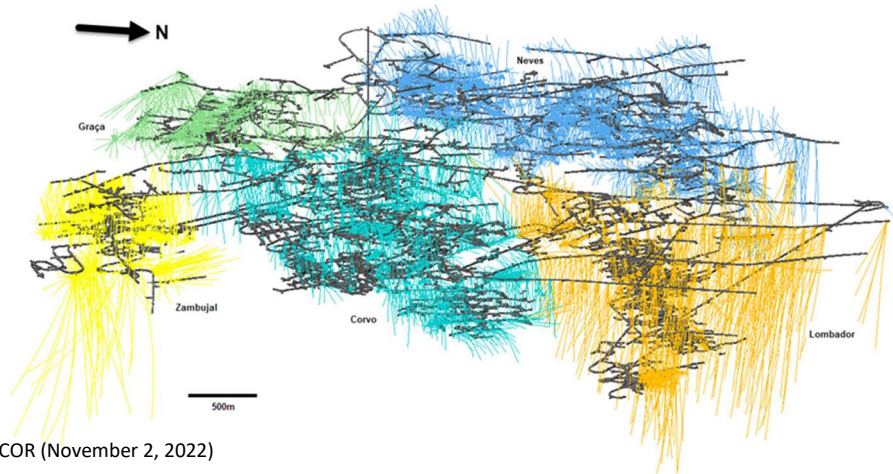

Source: SOMINCOR (November 2, 2022)

**b) Surface drillholes at Neves-Corvo Mine**

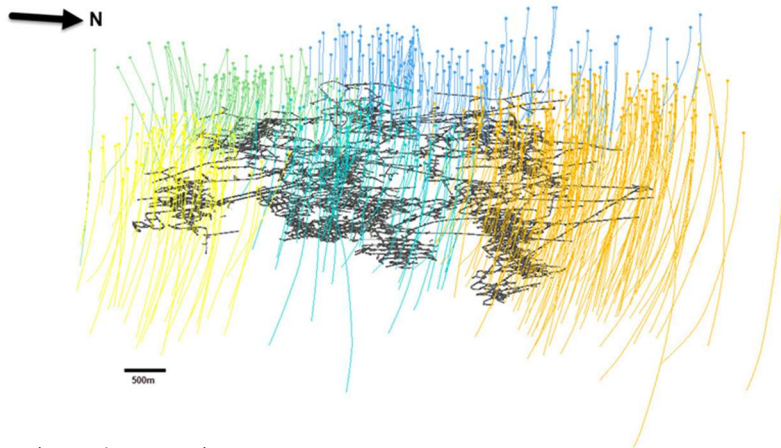

Source: SOMINCOR (November 2, 2022)

**c) Face Samples at Neves-Corvo Mine**

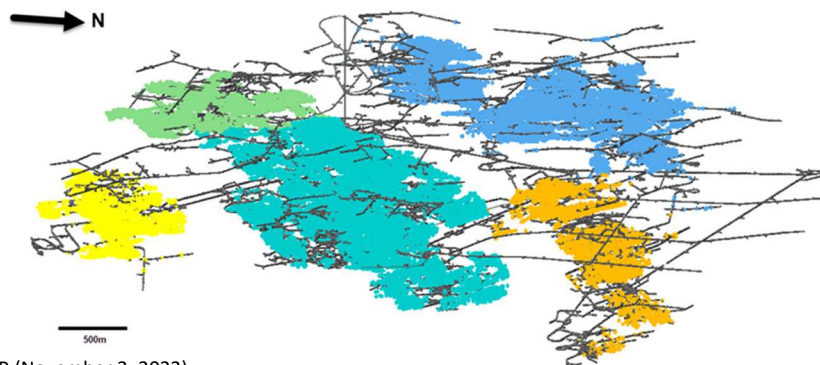

Source: SOMINCOR (November 2, 2022)

**Figure 14.1: Location of a) Underground Drillholes b) Surface Drillholes and c) Face Samples at Neves-Corvo**

### 14.3 Geological Interpretation and Domaining

The Neves-Corvo deposits are classified as VMS deposits and typically occur as lenses of polymetallic (Cu, Zn, Sn, Pb) massive sulphides and stockworks that formed at or near the seafloor in submarine volcanic environments. The deposits are located near the top of a dominantly volcanic sequence of the Volcanic Siliceous Complex (VSC) of Late Devonian-Early Carboniferous age (360-342Ma) which consists of two chemically distinct intervals of felsic volcanics separated by shale units, with a discontinuous black shale horizon immediately below the massive sulphide lenses. The thickness of the VSC in the Neves-Corvo area is approximately 300m. Overlying the mineralisation there is a repetition of volcanic-sedimentary and flysch units, approximately 350m thick. The whole assemblage has been folded into a gentle anticline orientated northwest-southeast, which plunges to the southeast, resulting in orebodies distributed on both limbs of the fold. All the deposits have been affected by low angle thrust faults and late-stage sub-vertical faults, resulting in repetition and thickening of the massive sulphides, in some areas up to 30m thick.

Seven sulphide deposits have been defined and include: Neves, Corvo, Graça, Zambujal, Lombador, Monte Branco and Semblana. The deposits are at various stages of exploration. Neves, Corvo, Graça, Zambujal and Lombador deposits are mature deposits with extensive exploration drilling and mining operations. Semblana and Monte Branco deposits are relatively new discoveries and have only been drilled from surface.

The geological interpretation used in the Mineral Resource estimate is guided by underground geological mapping, face samples and drillhole data. Domains are defined for each deposit based on texture, lithology and grade. The criteria used to define the main mineralisation types is shown in Table 14.2. Rubané mineralisation is now mainly depleted by mining and is modelled as stockwork. The authors consider the lithological domains used are based on extensive geological knowledge and are representative of the geological units present at the deposits.

<b>Mineralisation Type</b>	<b>Description</b>	<b>Geological Modelling Cut-Off Grade</b>	<b>Major Ore Mineral</b>
MC	Massive Copper	Cu $\geq$ 0.7%	Chalcopyrite
MT	Massive Tin	Sn $\geq$ 1%	Cassiterite
MZ	Massive Zinc	Zn $\geq$ 2%	Sphalerite
MP	Massive Lead	Pb $\geq$ 1%	Galena
FC	Stockwork Copper	Cu $\geq$ 0.7%	Chalcopyrite
FT	Stockwork Tin	Sn $\geq$ 1%	Cassiterite
FZ	Stockwork Zinc	Zn $\geq$ 2%	Sphalerite
5C (MCZ)	Massive Copper and Zinc	Cu $\geq$ 0.7% and Zn $\geq$ 3%	Chalcopyrite/Tennantite –Tetrahedrite/Sphalerite
5Z (MZP)	Massive Zinc and Lead	Zn $\geq$ 2% and Pb $\geq$ 1%	Sphalerite and Galena
ME	Massive Pyrite	-	Barren/Low Grade
FE	Stockwork Pyrite	-	Barren/Low Grade

For each deposit, the massive sulphide envelope (ME and host rock envelope) was modelled explicitly in cross-section using Vulcan 3D<sup>®</sup>. All other domains were modelled using Leapfrog Geo<sup>®</sup> software and 3-dimensional wireframe solids were constructed (MC, MT, MZ, MP, FC, FT, FE, MCZ, MZP and FE). Prior to import into Leapfrog Geo<sup>®</sup> the samples were composited to 1m intervals based on mineralisation type and coded as either 1 or 2 if below or above the geological modelling cut-off grade, respectively. Wireframe solids were then constructed using planes corresponding to the general strike and dip of the deposit to control the orientation of the generated wireframes. The extent of the modelled mineralisation was controlled by bounding wireframes to prevent over-extrapolation. Where available, the geological mapping and structural interpretation (including faulting) was used to control the wireframe construction. The wireframe solids were then imported into Vulcan<sup>®</sup> for adjustment if required. Where the copper and zinc wireframes overlap, priority was given to the copper wireframes.

#### **14.4 Drillhole Data Processing**

Drillhole and face samples located within the domain wireframes were selected for further data processing. Where the deposits form contiguous zones, samples located just beyond the extents of the deposit area were included in the estimation. Where different structural orientations are present, such as the location of different fold limbs, samples were further coded based on structural zone. This included subdivisions of the Neves deposit into Neves North and Neves South, subdivision of Graça deposit into Graça SW, Graça, and Upper Corvo and subdivision of Zambujal stockwork (FC) into Zambujal NE and Zambujal SW comprising separate fold limbs. The samples were coded by the principal domains based on deposit, mineralisation type and structural zone (where appropriate) and formed the basis of the Mineral Resource estimate.

#### **14.5 Compositing**

Historically, 1m intervals were used for sampling within massive sulphide mineralisation while sample intervals of up to 2m were allowed within the stockwork mineralisation. However, from 2015, 1m sample intervals were adopted for all mineralisation types (primarily to better reflect the variability of the stockwork mineralisation). Compositing is undertaken using a 1m composite sample length for both massive and stockwork mineralisation. The authors consider the use of a 1m composite length to be acceptable given the variability associated with the stockwork mineralisation. De-compositing associated with the minor population of 2m sample lengths from the pre-2015 drilling is considered less significant.

#### **14.6 Grade Capping**

Outlier restrictions are applied during grade estimation to limit the influence of composites with extreme assay values. The presence of outliers is assessed on a domain-by-domain basis using probability plots and statistical analysis. Grades higher than the designated outlier values were allowed to be included in the first pass of the grade estimation, however, were excluded from the second and third estimation passes. A summary of the outlier values used in the grade estimation is



shown in Table 14.3. No outlier restrictions were applied to deleterious elements (Hg, As, Sb, Bi and Se). No grade caps were applied to Monte Branco or Semblana.

<b>Table 14.3: Summary of Outlier Values Excluded from 2<sup>nd</sup> and 3<sup>rd</sup> Searches of Grade Estimation</b>				
<b>Deposit</b>	<b>Mineralisation</b>	<b>Outlier Values</b>		
<b>Corvo</b>	MZP	23% Zn, 10% Pb, 200ppm Ag		
	MCZ	29% Cu, 22.5% Zn, 1000ppm Ag		
	FC	29% Cu, 500ppm Ag		
	MC	29% Cu		
	MZ	27% Zn		
<b>Graça</b>		<b>Graça SW (Bd1)</b>	<b>Graça (Bd2)</b>	<b>Upper Corvo (Bd3)</b>
	MZP	22% Zn	-	23% Zn, 10% Pb, 200ppm Ag
	MCZ	33% Cu	32% Cu, 23% Zn	29% Cu, 22.5% Zn, 1000ppm Ag
	FC	33% Cu, 21% Zn	19% Cu, 12% Zn	29% Cu, 500ppm Ag
	MC	30% Cu	30% Cu	29% Cu
	MZ	26% Zn	-	27% Zn
<b>Neves</b>		<b>Neves North</b>		<b>Neves South</b>
	MC	30% Cu, 5% Zn, 2700ppm Ag		10.3% Zn, 722ppm Ag
	MCZ	24.4% Cu, 15.0% Cu, 1,000ppm Ag		24.0% Zn, 750ppm Ag
	FC	20.6% Cu, 9.0% Zn, 607ppm Ag		20.4% Cu, 13.0% Zn, 495ppm Ag
	MZ	1.3% Cu, 12.3% Zn, 130ppm Ag		2.4% Cu, 27.0% Zn, 7.0% Pb, 261ppm Ag
	MZP	0.7% Cu, 10.0% Zn		2.1% Cu, 27.5% Zn, 13.0% Pb, 391ppm Ag
<b>Zambujal</b>		<b>Zambujal NE</b>		<b>Zambujal SW</b>
	MZP	16.5% Zn, 7% Pb, 170ppm Ag		16.5% Zn, 7% Pb, 170ppm Ag
	MCZ	30% Cu, 480ppm Ag		30% Cu, 480ppm Ag
	FC	6.5% Cu, 900ppm Ag		9.5% Cu, 150ppm Ag
	FZ	8.5% Zn, 150ppm Ag		8.5% Zn, 150ppm Ag
	MC	29% Cu, 400ppm Ag		29% Cu, 400ppm Ag
	MP	10% Pb, 200ppm Ag		10% Pb, 200ppm Ag
	MZ	13% Zn, 180ppm Ag		13% Zn, 180ppm Ag
<b>Lombador</b>	MC	29.9% Cu, 6.7% Zn, 1300ppm Ag		
	MCZ	8.5% Cu, 14.5% Zn, 400ppm Ag		
	FC	16.3% Cu, 10.3% Zn, 270ppm Ag		
	MZ	3.1% Cu, 21.3% Zn, 4.6% Pb, 271ppm Ag		
	MZP	4.1% Cu, 12.5% Pb, 380ppm Ag		
	FZ	3.2% Cu, 14.4% Zn, 6.3% Pb, 130ppm Ag		
	MP	1.6% Cu, 2.8% Zn, 176ppm Ag		

The authors consider the outlier values used and the approach for restricting outlier values during grade estimation is generally appropriate. The authors note, that areas containing the highest copper and zinc grades have generally been depleted by mining and the influence of these grades on the Mineral Resource estimate is therefore further reduced.

## 14.7 Metal Correlations

Correlation statistics were undertaken to identify relationships between elements of interest. Density (de) was also included in the analysis. The correlation between density, sulphur and iron is used to estimate density in the Mineral Resource estimate and is discussed in Section 11.3. Correlation analysis is undertaken for all deposits and for each mineralisation type. Examples of the metal correlations for massive zinc (MZ), massive copper (MC) and stockwork copper (FC) zones at Lombador are shown in Table 14.4, Table 14.5 and Table 14.6, respectively with significant correlations shown in bold.



## 14.8 Variography

Continuity analysis was undertaken prior to variography and was based on a Normal Score transformation of the 1m composite data. Continuity analysis refers to the spatial correlation between sample pairs to determine the major axis of spatial continuity. Horizontal, across strike and down dip continuity maps were examined (and their underlying variograms) to determine the direction of greatest and least continuity. The analysis was undertaken for all domains and elements including Cu, Zn, Sn, Pb, Su, Fe, Ag, Hg, As, Sb, Bi, Au, Se and In where sufficient sample pairs were available. Continuity analysis was also undertaken separately for deposits with differing structural orientations due to folding as follows:

- Neves: Neves North and Neves South;
- Graça: Graça SW, Graça, and Upper Corvo; and
- Zambujal FC zone: Zambujal SW and Zambujal NE.

Variogram modelling used the 1m composite data. Directional and down hole variograms were created in the orientations defined by the continuity analysis. The structural subdivisions used in the continuity analysis were maintained. Variography was undertaken for all deposits except Monte Branco where insufficient sample pairs were available. Variography was undertaken for each domain for Cu, Zn, Sn, Pb, Su, Fe, Ag, Hg, As, Sb, Bi, Au, Se and In, where sufficient sample pairs were available.

The major axis was defined based on the orientation of greatest continuity. The semi-major axis was defined based on the orientation of next greatest continuity and orientated perpendicular to the major axis. The remaining orthogonal direction (minor axis), orientated perpendicular to the major and semi-major axis, was then defined. The nugget variances were modelled from the down hole variograms. Variograms were modelled using 2 structure spherical models. Examples of the modelled variograms for massive zinc (MZ), massive copper (MC) and stockwork copper (FC) zones at Lombador are shown in Table 14.7, Table 14.8 and Table 14.9, respectively.

**Table 14.7: Variogram Model for Massive Zinc (MZ) Zone at Lombador**

Element	Rotation ZXY (Degrees) (Direction 1/2/3)	Nugget Effect	Structure 1				Structure 2			
			Sill	Axis Distance (m)			Sill	Axis Distance (m)		
				Major	Semi- Major	Minor		Major	Semi- Major	Minor
Cu	50 / -30 / 0	0.41	0.32	30	20	10	0.27	120	70	15
Zn	57 / -29 / 8	0.32	0.30	34	27	14	0.38	100	50	20
Sn	63 / -39 / 8	0.39	0.44	35	26	34	0.17	180	115	35
Pb	37 / -39 / -8	0.38	0.48	23	10	8	0.14	50	20	15
S	63 / -39 / -8	0.12	0.40	40	40	20	0.48	220	190	60
Fe	62 / -29 / 6	0.21	0.28	33	22	15	0.51	144	112	28
Ag	53 / -39 / 8	0.25	0.35	14	10	10	0.40	132	46	40
Hg	48 / -34 / 10	0.30	0.28	70	60	20	0.42	130	100	30
As	57 / -29 / 8	0.23	0.32	90	80	27	0.45	310	240	28
Sb	52 / -29 / 6	0.40	0.40	17	17	17	0.20	114	85	35
Bi	48 / -39 / 8	0.25	0.44	10	30	10	0.31	100	50	20
Au	57 / -29 / 8	0.32	0.30	34	27	14	0.38	100	50	20
Se	58 / -34 / 10	0.47	0.42	15	15	15	0.11	55	50	25
In	62 / -29 / 6	0.22	0.55	12	12	10	0.23	60	30	20

**Table 14.8: Variogram Model for Massive Copper (MC) Zone at Lombador**

Element	Rotation ZXY (Degrees) (Direction 1/2/3)	Nugget Effect	Structure 1				Structure 2			
			Sill	Axis Distance (m)			Sill	Axis Distance (m)		
				Major	Semi-Major	Minor		Major	Semi-Major	Minor
Cu	61 / -36 / 20	0.25	0.47	13	9	5	0.28	51	30	15
Zn	63 / -39 / 8	0.33	0.45	8	6	6	0.22	40	35	20
Sn	63 / -39 / 8	0.29	0.56	19	14	13	0.15	90	73	26
Pb	50 / -40 / 0	0.45	0.30	16	15	9	0.25	140	120	52
S	63 / -39 / 8	0.21	0.42	15	20	14	0.37	54	42	15
Fe	52 / -29 / 6	0.20	0.25	17	15	14	0.55	115	74	33
Ag	50 / -30 / 0	0.35	0.53	7	6	10	0.12	20	12	13
Hg	50 / -30 / 0	0.22	0.43	10	10	5	0.35	50	25	15
As	50 / -30 / 0	0.40	0.22	20	20	6	0.38	120	64	32
Sb	60 / -37 / 16	0.20	0.61	9	8	7	0.19	35	25	20
Bi	52 / -29 / 6	0.45	0.42	7	4	7	0.13	25	23	9
Au	61 / -36 / 20	0.25	0.47	13	9	5	0.28	51	30	15
Se	62 / -29 / 6	0.39	0.48	12	12	10	0.13	80	64	28
In	57 / -34 / 23	0.43	0.42	8	8	7	0.15	30	25	20

**Table 14.9: Variogram Model for Stockwork Copper (FC) Zone at Lombador**

Element	Rotation ZXY (Degrees) (Direction 1/2/3)	Nugget Effect	Structure 1				Structure 2			
			Sill	Axis Distance (m)			Sill	Axis Distance (m)		
				Major	Semi-Major	Minor		Major	Semi-Major	Minor
Cu	49 / -38 / 12	0.36	0.34	8	8	10	0.30	50	40	18
Zn	50 / -40 / 0	0.34	0.38	10	8	8	0.28	90	50	40
Sn	51 / -30 / 3	0.27	0.26	15	10	10	0.47	80	50	40
Pb	54 / -30 / -3	0.37	0.40	20	10	10	0.23	200	50	40
S	47 / -29 / 6	0.31	0.25	44	34	25	0.44	176	94	26
Fe	53 / -39 / 8	0.30	0.25	29	25	15	0.45	200	150	47
Ag	50 / -40 / 0	0.57	0.21	40	35	25	0.22	140	115	30
Hg	40 / -30 / 0	0.53	0.29	80	10	10	0.18	120	50	30
As	66 / -36 / 20	0.38	0.15	18	15	10	0.47	140	120	30
Sb	59 / -26 / 16	0.36	0.42	10	10	10	0.22	100	25	20
Bi	40 / -40 / 0	0.55	0.36	18	16	10	0.09	100	55	32
Au	40 / -40 / 0	0.55	0.36	18	16	10	0.09	100	55	32
Se	58 / -29 / 28	0.66	0.23	39	8	7	0.11	90	30	26
In	53 / -40 / -4	0.46	0.44	11	10	10	0.10	45	35	20

The authors consider the overall quality of the experimental variograms are acceptable and are generally based on a significant number of sample pairs which have been sufficiently domained. Confidence in the modelled variograms is therefore high due to the clearly defined continuity displayed by the experimental variograms. Variography for Semblana is based on wider drillhole spacing (>70m) and as such there is lower confidence in the variography. Semblana is classified as wholly Inferred Mineral Resource. No variography could be defined at Monte Branco due to the limited number of sample pairs. Monte Branco is also classified as a wholly Inferred Mineral Resource.

#### 14.9 Block Modelling

Block models defining the mineralised zones were constructed in Vulcan 3D® using the domain wireframes to define the block model domains.

For Neves, Corvo, Graça, Zambujal, Lombador and Monte Branco a model prototype with a parent cell size of 5m x 5m x 5m (X, Y, Z) was used for copper and tin mineralised zones, a parent cell size of 10m

x 10m x 5m was used for zinc, lead and barren sulphide (pyrite) zones and a parent cell size of 50m x 50m x 20m was used for waste. Sub-cell splitting was enabled down to a minimum cell size of 1m x 1m x 1m. The models were rotated to 303° to align with the general strike of the deposits.

For Semblana, a model prototype with a parent cell size of 15m x 15m x 5m was used. Sub-cell splitting was enabled down to a minimum cell size of 7.5m x 7.5m x 5m. The Semblana model was not rotated.

#### **14.10 Density**

Due to the strong positive correlation between sulphur, iron and density and given the large number of sulphur and iron assays contained in the database, SOMINCOR elects to use linear regression formulae to estimate density in the block model as detailed in Section 11.3. For Semblana, density was estimated into the block model using the density values contained in the drillhole database. Any remaining unestimated blocks were assigned densities of 4.4t/m<sup>3</sup> in massive mineralisation or 3.2t/m<sup>3</sup> in stockwork.

#### **14.11 Grade Estimation**

Grade estimation for Cu, Pb, Zn, S, Fe, Sn, As, Sb, Hg, Ag, Au, Bi, Se and In was undertaken on the blocks defined within each domain. The domains were treated as hard boundaries and as such composites from an adjacent domain could not be used in the grade estimation of another domain. Ordinary kriging (OK) was used as the principal estimation method for all deposits except for Monte Branco where inverse distance weighting (IDW) estimation was used.

Grade estimation was run in a three-pass plan, the second and third passes using progressively larger search radii to enable the estimation of blocks unestimated on the previous pass. The search parameters were defined by the variography, with the first search distances corresponding to the variogram range at 2/3<sup>ds</sup> of the sill value, the second search corresponding to the variogram range and the third search expanded beyond the variogram range to estimate any remaining domain blocks.

Sample weighting during grade estimation was determined by the variogram model parameters for the OK method. Any blocks containing negative grades after estimation, resulting from negative kriging weights, were set to the analysis detection limit for that element. IDW estimation was used at Monte Branco as no suitable variograms for these zones could be derived. Search distances for Monte Branco were based on the general drillhole spacing.

Discretisation was set at 2 x 2 x 2 for copper and tin mineralised zones and 4 x 4 x 2 for zinc, lead and barren sulphide (pyrite) zones.

A summary of the grade estimation parameters is shown in Table 14.10.

**Table 14.10: Grade Estimation Parameters**

Deposit	Search	Minimum Number of Composites	Maximum Number of Composites	Maximum Number of Composites Per Octant	
Neves-Corvo Deposits	1st	5	32	4	
	2nd	5	32	4	
	3rd	2	32	4	
Semblana	MC	1st	8	20	-
		2nd	5	20	-
		3rd	5	20	-
	FC	1st	6	15	-
		2nd	5	20	-
		3rd	5	20	-
	ME FE	1st	7	20	-
		2nd	5	20	-
		3rd	5	20	-

Notes:  
 1.Semblana MC - 1st search of 70m x 70m x 10m with an expansion of 1.5 times for search 2 and an expansion of 3 times for search 3. Max number of composites per drillhole is 7;  
 2.Semblana FC - 1st search of 70m x 70m x 10m with an expansion of 2 times for search 2 and an expansion of 3 times for search 3. Max number of composites per drillhole is 5;  
 3.Semblana ME, FE - 1st search of 80m x 80m x 15m with an expansion of 2 times for search 2 and an expansion of 3 times for search 3. Max number of composites per drillhole is 6;  
 4. Semblana search ellipse orientations controlled by dynamic anisotropy.

## 14.12 Model Validation

Model validation methods included an on-screen visual assessment of the composite and block model grades, a statistical grade comparison and a SWATH Analysis. The authors consider that globally no indications of significant over or under estimation were apparent in the models nor were any obvious interpolation issues identified. From the perspective of conformance of the average model grades to the input data, the authors consider the grade estimation adequately represents the sample data used.

## 14.13 Mineral Resource Reconciliation

Reconciliation comparing the block model estimates against planned and actual production data is undertaken by the SOMINCOR geological department on a monthly basis and includes the following evaluations:

- **Mineral Resource Model** – An evaluation of the Mineral Resource estimates contained within the mined out stopes using the Cavity Monitoring System (CMS) survey over the reconciliation period. Sidewall dilution when mining next to backfill in secondary stopes and adjustments to account for material stored in surface stockpiles are accounted for;
- **‘Broken Ore’** – Estimate of tonnage and grade of mined ore based on face samples from development headings. Grades are apportioned to areas on the development and plan weighted by distance from the face sample. Volume, tonnage and dilution are then calculated from survey data.
- **Planned Production (Annual)** – planned stope production based on the annual mine design and annual block model. The block model contained within the planned stopes is evaluated and factors are applied for unplanned dilution and mining recovery;
- **Planned Production (Monthly)** – planned stope production based on the most up to date block model available; and

- **Plant Production** – plant reported production figures based on tonnes processed and back calculated grade.

### 14.13.1 Copper Zones

A summary of the annual reconciliation for the copper zones for 2021 is shown in Table 14.11.

Source	Ore Tonnes (t)	Cu Grade (%)	Cu Metal (t)
Resource Model	2,611,554	1.8	46,854
Broken Ore	2,631,766	1.9	50,481
Planned Production (Annual)	2,593,560	2.0	51,094
Planned Production (Monthly)	2,596,750	1.8	46,561
Plant Production	2,564,313	1.9	47,645

The monthly reconciliations of the copper zones for tonnes, grade and contained Cu metal are shown in Figure 14.2, Figure 14.3 and Figure 14.4, respectively.

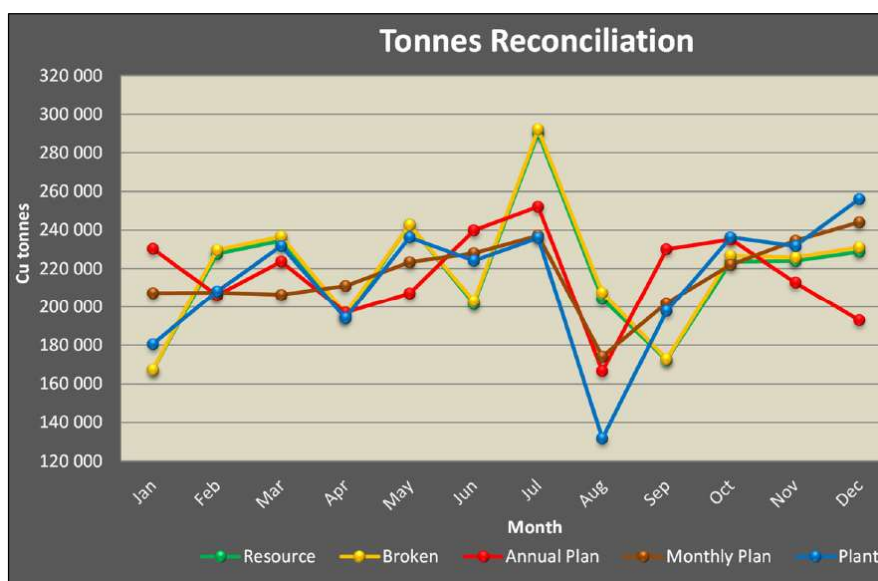

**Figure 14.2: Copper Zones - Reconciliation of Tonnes (2021)**

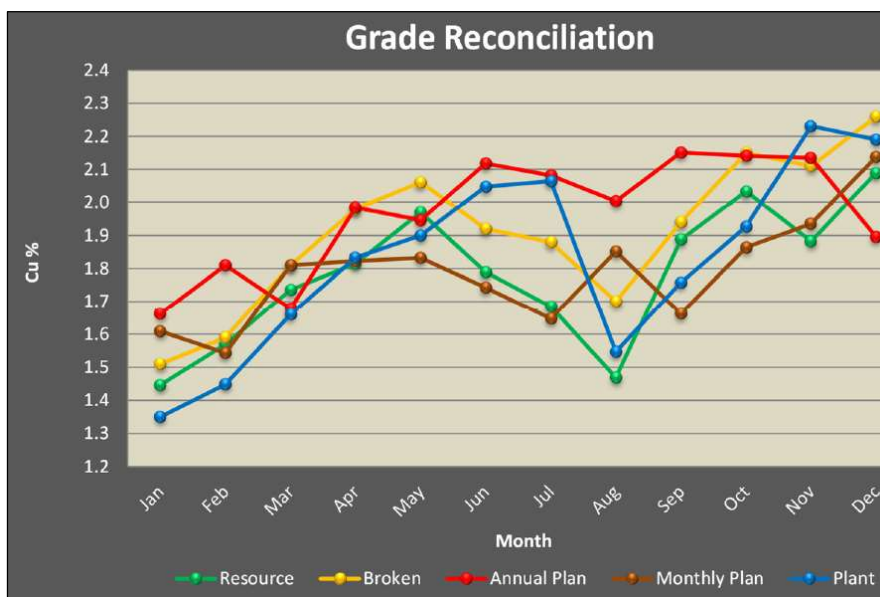

**Figure 14.3: Copper Zones – Reconciliation of Cu Grade (2021)**

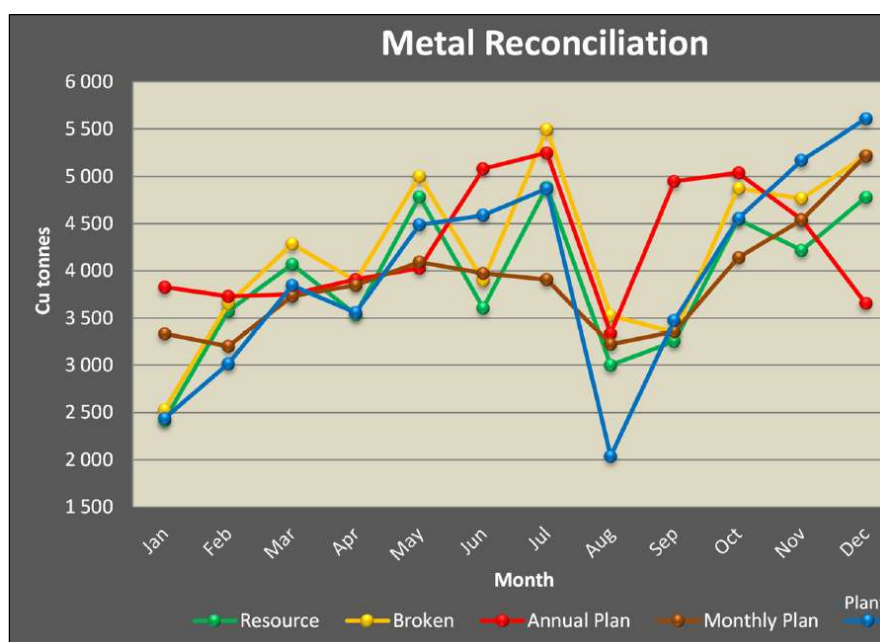

**Figure 14.4: Copper Zones – Reconciliation of Contained Cu Metal (2021)**

On an annual basis, the reconciliations show a generally good agreement between the resource model, plant production and planned production (monthly), and report within 2% difference for contained Cu metal. Broken ore and planned production (annual) report slightly higher grades (1.9% and 2.0% Cu, respectively) compared to the resource model grade of 1.8% Cu. Reported tonnes for all reconciliations are within 2% difference. Overall, the results of the reconciliations are within acceptable tolerances and support the resource modelling methodology.

On a monthly basis, a greater degree of variability is observed due to a complex interaction of operational factors. In particular, a reduction in underground development during the COVID-19



pandemic has resulted in reduced drill access for pre-production drilling. As a result, instances of pre-production drilling falling behind mining production has increased along with the frequency of mineralisation being found outside of the resource model.

### 14.13.2 Zinc Zones

A summary of the annual reconciliation for the zinc zones for 2021 is shown in Table 14.12

<b>Table 14.12: Summary Annual Reconciliation (2021) for Zinc Zones</b>			
<b>Source</b>	<b>Ore Tonnes (t)</b>	<b>Zn Grade (%)</b>	<b>Zn Metal (t)</b>
Resource Model	1,145,368	8.2	93,728
Broken Ore	1,148,118	8.1	93,081
Planned Production (Annual)	1,152,760	8.3	95,400
Planned Production (Monthly)	1,104,982	8.6	94,479
Plant Production	1,059,800	7.8	82,469

The monthly reconciliations of the zinc zones for tonnes, grade and contained Zn metal are shown in Figure 14.5, Figure 14.6 and Figure 14.7, respectively.

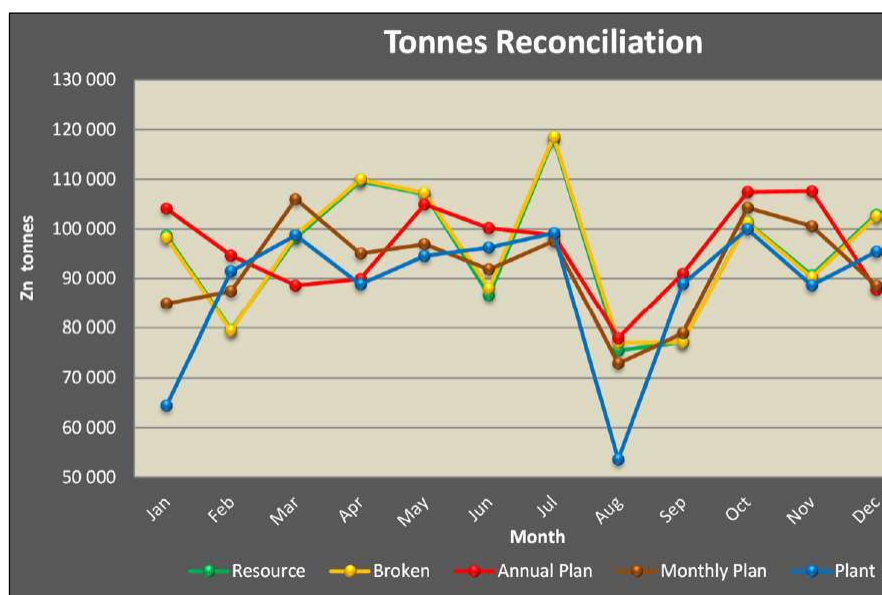

**Figure 14.5: Zinc Zones - Reconciliation of Tonnes (2021)**

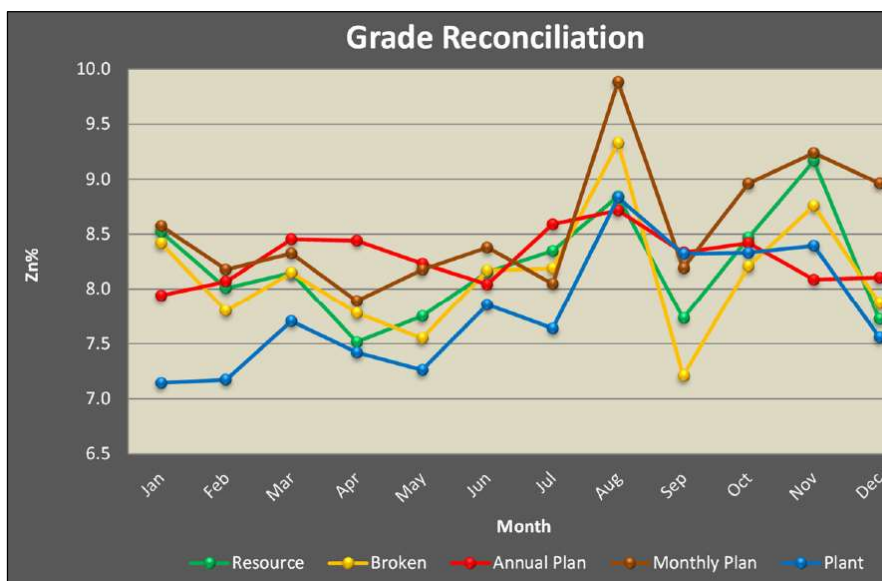

Figure 14.6: Zinc Zones – Reconciliation of Zn Grade (2021)

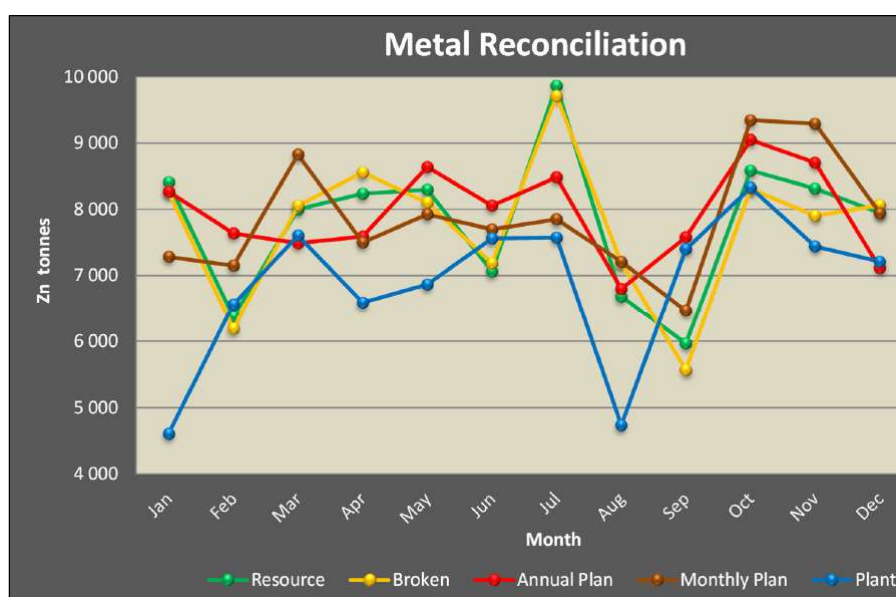

Figure 14.7: Zinc Zones – Reconciliation of Contained Zn Metal (2021)

On an annual basis, the reconciliations show a generally good agreement between the resource model, broken ore and planned production (annual) and report within 2% difference for contained Zn metal. Planned production (monthly) reports slightly lower tonnes and a higher grade (8.6% Zn) compared to the resource model grade of 8.2% Zn, however, contained Zn metal is within 1%. The authors consider these reconciliations are within acceptable tolerances and again supports the resource modelling methodology. Plant production reports lower tonnes and grade than the other reconciliations, however, reconciliation of plant production for zinc during this period is complicated by the ramp up of the ZEP.

On a monthly basis, again, a greater degree of variability is observed for reasons previously stated.

#### **14.14 Mineral Resource Depletion and Non-Recoverable Mineral Resources**

All underground development and stopes are regularly surveyed using Total Station and CMS survey methods. The information is imported into Vulcan 3D<sup>®</sup> and used to build up 3D triangulations of the mined-out regions. These areas are then incorporated into the block model using a MINED field with all remaining unmined material coded as 0 which is then used to select the unmined Mineral Resources within the block model during Mineral Resource evaluation.

Non-recoverable Mineral Resources include areas which will never be exploited for reasons such as proximity to mine infrastructure. Non-recoverable Mineral Resources are defined using wireframes and coded into the block model using the field 'mcd'. A value of 99 is assigned in the block model to any resources that are considered non-recoverable. The last update of non-recoverable Mineral Resources was undertaken in 2021.

The Mineral Resources were depleted based on a mine survey dated November 30, 2022, and then further depleted by forecast production for December 2022 to reflect an effective reporting date of December 31, 2022.

#### **14.15 Cut-Off Grades for Mineral Resource Evaluation**

Historically, cut-off grades of 1.0% Cu and 3.0% Zn were used for Mineral Resource evaluation of copper zones and zinc zones, respectively. In 2019, the cut-off grade for reporting the zinc zones was reviewed and subsequently increased to 4.5% Zn. The authors consider the change in cut-off grade to be appropriate and better aligns the Mineral Resources and Mineral Reserves estimates. To further this, for future Mineral Resource estimates it is recommended that the use of an NSR cut-off value should be considered.

The cut-off grades used to report the December 31, 2022, Mineral Resource estimate are 1.0% Cu for copper zones and 4.5% Zn for zinc zones.

#### **14.16 Mineral Resource Classification**

Mineral Resource estimate classification was undertaken on the basis of confidence in the drillhole data, the geological interpretation, geological continuity, data density and orientation, spatial grade continuity and confidence in the Mineral Resource estimation. Classification was initially set in the block models using the search passes encountered during grade estimation for the main element of the domain as follows:

- Cu estimation in copper domains;
- Zn estimation in zinc domains;
- Sn estimation in tin domains; and
- Pb estimation in lead domains.

A summary of the main element and maximum (major axis) distances (d) used during Mineral Resource classification are shown in Table 14.13.

Deposit	Structure	Mineralisation Type	Measured Resources (m)			Indicated Resources (m)		
			Major Axis	Semi-Major Axis	Minor Axis	Major Axis	Semi-Major Axis	Minor Axis
Corvo	1 Corvo	MC	d_Cu ≤ 24	d_Cu ≤ 23	d_Cu ≤ 8	d_Cu ≤ 70	d_Cu ≤ 65	d_Cu ≤ 23
		MCZ	d_Cu ≤ 34	d_Cu ≤ 29	d_Cu ≤ 19	d_Cu ≤ 83	d_Cu ≤ 72	d_Cu ≤ 46
		FC	d_Cu ≤ 22	d_Cu ≤ 17	d_Cu ≤ 7	d_Cu ≤ 75	d_Cu ≤ 57	d_Cu ≤ 23
		FT	d_Sn ≤ 16	d_Sn ≤ 9	d_Sn ≤ 5	d_Sn ≤ 56	d_Sn ≤ 34	d_Sn ≤ 18
		MT	d_Sn ≤ 4	d_Sn ≤ 3	d_Sn ≤ 2	d_Sn ≤ 44	d_Sn ≤ 38	d_Sn ≤ 18
		MZ/FZ	d_Zn ≤ 8	d_Zn ≤ 6	d_Zn ≤ 5	d_Zn ≤ 56	d_Zn ≤ 44	d_Zn ≤ 37
		MZP	d_Zn ≤ 36	d_Zn ≤ 33	d_Zn ≤ 14	d_Zn ≤ 98	d_Zn ≤ 90	d_Zn ≤ 37
Graça	1 (Graça SW)	MP	d_Pb ≤ 17	d_Pb ≤ 16	d_Pb ≤ 9	d_Pb ≤ 132	d_Pb ≤ 115	d_Pb ≤ 26
		MC	d_Cu ≤ 6	d_Cu ≤ 6	d_Cu ≤ 4	d_Cu ≤ 35	d_Cu ≤ 31	d_Cu ≤ 16
		MCZ	d_Cu ≤ 23	d_Cu ≤ 20	d_Cu ≤ 9	d_Cu ≤ 54	d_Cu ≤ 46	d_Cu ≤ 21
		FC	d_Cu ≤ 16	d_Cu ≤ 10	d_Cu ≤ 3	d_Cu ≤ 63	d_Cu ≤ 39	d_Cu ≤ 9
		MZ	d_Zn ≤ 18	d_Zn ≤ 16	d_Zn ≤ 8	d_Zn ≤ 68	d_Zn ≤ 68	d_Zn ≤ 36
	2 (Graça)	MZP	d_Zn ≤ 18	d_Zn ≤ 9	d_Zn ≤ 3	d_Zn ≤ 62	d_Zn ≤ 32	d_Zn ≤ 11
		MP	d_Pb ≤ 7	d_Pb ≤ 5	d_Pb ≤ 2	d_Pb ≤ 56	d_Pb ≤ 43	d_Pb ≤ 28
		MC	d_Cu ≤ 15	d_Cu ≤ 14	d_Cu ≤ 7	d_Cu ≤ 84	d_Cu ≤ 78	d_Cu ≤ 19
		MCZ	d_Cu ≤ 19	d_Cu ≤ 19	d_Cu ≤ 9	d_Cu ≤ 92	d_Cu ≤ 69	d_Cu ≤ 39
	3 (Upper Corvo)	FC	d_Cu ≤ 7	d_Cu ≤ 6	d_Cu ≤ 2	d_Cu ≤ 61	d_Cu ≤ 54	d_Cu ≤ 8
		MZ/MZP	d_Zn ≤ 15	d_Zn ≤ 14	d_Zn ≤ 11	d_Zn ≤ 55	d_Zn ≤ 44	d_Zn ≤ 27
		MP	d_Pb ≤ 18	d_Pb ≤ 12	d_Pb ≤ 10	d_Pb ≤ 79	d_Pb ≤ 49	d_Pb ≤ 37
		MC	d_Cu ≤ 24	d_Cu ≤ 23	d_Cu ≤ 8	d_Cu ≤ 70	d_Cu ≤ 65	d_Cu ≤ 23
		MCZ	d_Cu ≤ 34	d_Cu ≤ 29	d_Cu ≤ 19	d_Cu ≤ 83	d_Cu ≤ 72	d_Cu ≤ 46
Lombador	1 Lombador	FC	d_Cu ≤ 22	d_Cu ≤ 17	d_Cu ≤ 7	d_Cu ≤ 75	d_Cu ≤ 57	d_Cu ≤ 23
		MZ	d_Zn ≤ 8	d_Zn ≤ 6	d_Zn ≤ 5	d_Zn ≤ 56	d_Zn ≤ 44	d_Zn ≤ 37
		MZP	d_Zn ≤ 36	d_Zn ≤ 33	d_Zn ≤ 14	d_Zn ≤ 98	d_Zn ≤ 90	d_Zn ≤ 37
		MP	d_Pb ≤ 17	d_Pb ≤ 16	d_Pb ≤ 9	d_Pb ≤ 132	d_Pb ≤ 115	d_Pb ≤ 26
		MC	d_Cu ≤ 7	d_Cu ≤ 5	d_Cu ≤ 3	d_Cu ≤ 51	d_Cu ≤ 30	d_Cu ≤ 15
		MCZ	d_Cu ≤ 11	d_Cu ≤ 11	d_Cu ≤ 5	d_Cu ≤ 65	d_Cu ≤ 45	d_Cu ≤ 20
		FC	d_Cu ≤ 5	d_Cu ≤ 4	d_Cu ≤ 4	d_Cu ≤ 50	d_Cu ≤ 40	d_Cu ≤ 18
Neves	1 (Neves North)	FT	d_Sn ≤ 9	d_Sn ≤ 8	d_Sn ≤ 7	d_Sn ≤ 100	d_Sn ≤ 80	d_Sn ≤ 45
		MZ/FZ	d_Zn ≤ 20	d_Zn ≤ 13	d_Zn ≤ 6	d_Zn ≤ 100	d_Zn ≤ 50	d_Zn ≤ 20
		MZP	d_Zn ≤ 29	d_Zn ≤ 21	d_Zn ≤ 10	d_Zn ≤ 115	d_Zn ≤ 80	d_Zn ≤ 27
		MP	d_Pb ≤ 11	d_Pb ≤ 5	d_Pb ≤ 7	d_Pb ≤ 50	d_Pb ≤ 47	d_Pb ≤ 20
		MC	d_Cu ≤ 8	d_Cu ≤ 6	d_Cu ≤ 5	d_Cu ≤ 75	d_Cu ≤ 56	d_Cu ≤ 20
	2 (Neves South)	MCZ	d_Cu ≤ 10	d_Cu ≤ 7	d_Cu ≤ 5	d_Cu ≤ 90	d_Cu ≤ 50	d_Cu ≤ 25
		FC	d_Cu ≤ 3	d_Cu ≤ 3	d_Cu ≤ 2	d_Cu ≤ 50	d_Cu ≤ 30	d_Cu ≤ 15
		FT	d_Sn ≤ 10	d_Sn ≤ 8	d_Sn ≤ 8	d_Sn ≤ 145	d_Sn ≤ 120	d_Sn ≤ 90
		MZ	d_Zn ≤ 4	d_Zn ≤ 3	d_Zn ≤ 2	d_Zn ≤ 70	d_Zn ≤ 20	d_Zn ≤ 15
		MZP	d_Zn ≤ 9	d_Zn ≤ 3	d_Zn ≤ 3	d_Zn ≤ 75	d_Zn ≤ 15	d_Zn ≤ 10
Zambujal	1 and 2 (Zambujal NE and Zambujal SW)	FZ	d_Zn ≤ 20	d_Zn ≤ 13	d_Zn ≤ 6	d_Zn ≤ 100	d_Zn ≤ 50	d_Zn ≤ 20
		MP	d_Pb ≤ 3	d_Pb ≤ 3	d_Pb ≤ 1	d_Pb ≤ 60	d_Pb ≤ 40	d_Pb ≤ 20
		MC	d_Cu ≤ 10	d_Cu ≤ 7	d_Cu ≤ 6	d_Cu ≤ 41	d_Cu ≤ 32	d_Cu ≤ 24
		MCZ	d_Cu ≤ 20	d_Cu ≤ 15	d_Cu ≤ 13	d_Cu ≤ 66	d_Cu ≤ 43	d_Cu ≤ 31
	1 (Zambujal NE) 2 (Zambujal SW)	MZ/FZ	d_Zn ≤ 6	d_Zn ≤ 6	d_Zn ≤ 5	d_Zn ≤ 40	d_Zn ≤ 35	d_Zn ≤ 25
		MZP	d_Zn ≤ 8	d_Zn ≤ 5	d_Zn ≤ 4	d_Zn ≤ 47	d_Zn ≤ 25	d_Zn ≤ 22
		MP	d_Pb ≤ 3	d_Pb ≤ 2	d_Pb ≤ 1	d_Pb ≤ 44	d_Pb ≤ 24	d_Pb ≤ 19
1 (Zambujal NE) 2 (Zambujal SW)	FC	d_Cu ≤ 3	d_Cu ≤ 3	d_Cu ≤ 1	d_Cu ≤ 35	d_Cu ≤ 33	d_Cu ≤ 15	
	FC	d_Cu ≤ 4	d_Cu ≤ 3	d_Cu ≤ 2	d_Cu ≤ 28	d_Cu ≤ 21	d_Cu ≤ 17	

Note: The same search parameters and varography used for Lombador and Neves North

Following this, a second level of Mineral Resource classification was used. At Neves, Corvo, Graça and Zambujal all blocks estimated on the first-pass but which were estimated using only surface drillholes were re-classified as Indicated Mineral Resources. At Lombador, all blocks estimated on the first-pass were re-classified as Indicated Mineral Resources unless they had been estimated using face samples

and/or pre-production drillhole samples. At Zambujal, all copper stockwork mineralisation located between Zambujal and Semblana was classified as Inferred Mineral Resources due to low confidence in the geological continuity of this area. Monte Branco and Semblana were classified as wholly Inferred Mineral Resources as these deposits were estimated using wide spaced surface drillholes only. Mineral Resource classification was coded in the block models using the field 'rcc'.

The Mineral Resources classification for Neves, Corvo, Graça, Zambujal and Lombador deposits are shown in Figure 14.8 and Figure 14.9. Monte Branco and Semblana deposits are not shown but are classified as wholly Inferred Mineral Resources.

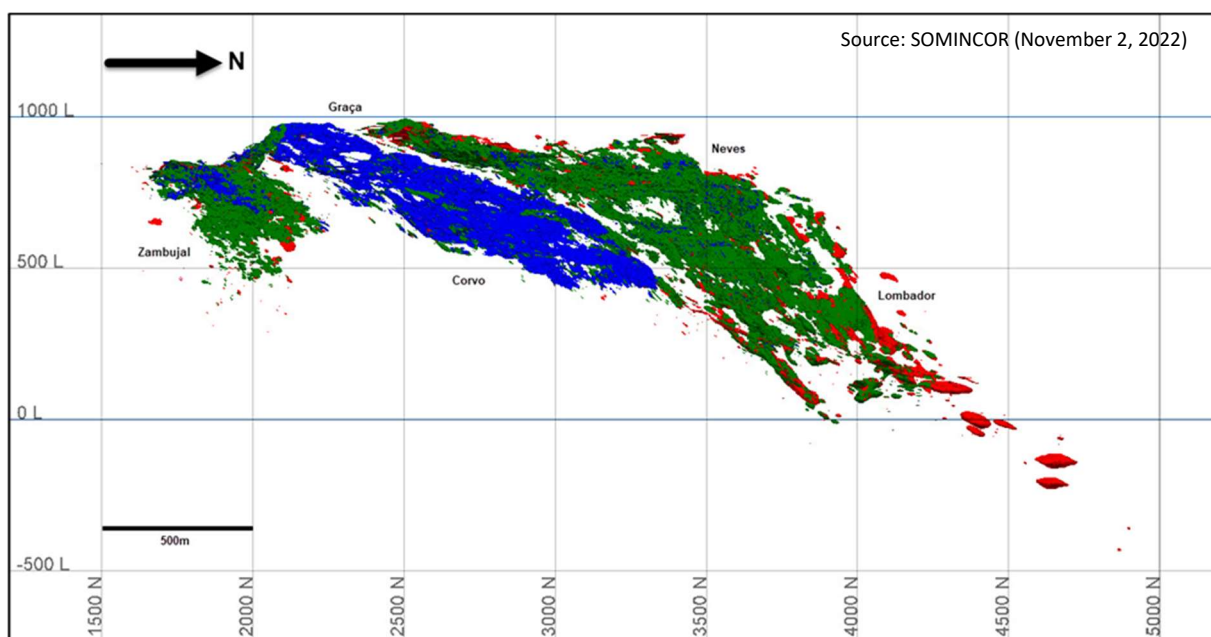

**Figure 14.8: Isometric View of Copper Zones Showing Mineral Resource Classification (Measured Resources in Blue, Indicated Resources in Green and Inferred Resources in Red)**

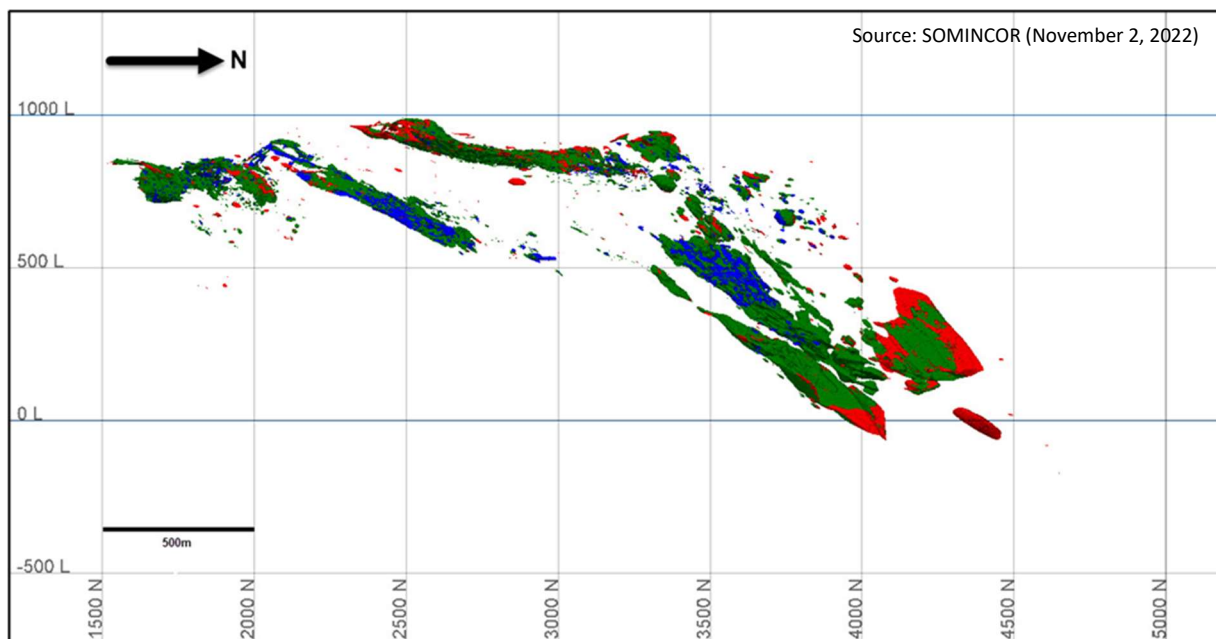

**Figure 14.9: Isometric View of Zinc Zones Showing Mineral Resource Classification (Measured Resources in Blue, Indicated Resources in Green and Inferred Resources in Red)**

The authors consider the Mineral Resource classification methodology to be generally acceptable. Further refinements to the methodology could include the use of perimeter strings or wireframes to improve definition of the extents and boundaries of the different resource classifications.

#### **14.17 Mineral Resource Statement**

The Mineral Resource estimates for the Neves-Corvo deposits (Neves, Corvo, Graça, Zambujal, Lombador and Monte Branco) and the Semblana deposit are classified in accordance with the CIM Definition Standards for Mineral Resources and Mineral Reserves (2014). A summary of the Mineral Resource statement is shown in Table 14.14, Table 14.15 and Table 14.16. The effective date of the Mineral Resource estimate is December 31, 2022.

The stated Mineral Resources are not materially affected by any known environmental, permitting, legal, title, taxation, socio-economic, marketing, political or other relevant issues, to the best knowledge of the author. There are no known mining, metallurgical, infrastructure, or other factors that materially affect this Mineral Resource estimate, at this time.

**Table 14.14: Audited Mineral Resource Statement for Neves-Corvo Copper Zones  
 Wardell Armstrong International (WAI), effective December 31, 2022**

Resource Classification	Tonnage (kt)	Grade				Metal			
		Cu (%)	Zn (%)	Pb (%)	Ag (g/t)	Cu (kt)	Zn (kt)	Pb (kt)	Ag (Koz)
Measured	8,222	3.5	0.8	0.3	43	288	66	24	11,440
Indicated	47,811	2.0	0.8	0.3	44	971	386	165	67,383
<b>Measured + Indicated</b>	<b>56,033</b>	<b>2.2</b>	<b>0.8</b>	<b>0.3</b>	<b>44</b>	<b>1,259</b>	<b>452</b>	<b>189</b>	<b>78,824</b>
Inferred	14,185	1.8	0.6	0.2	29	255	90	34	13,259

Notes:  
 1. Mineral Resources are reported at a cut-off grade of 1.0% Cu  
 2. Mineral Resources are not reserves until they have demonstrated economic viability based on a feasibility study or pre-feasibility study;  
 3. Mineral Resources are reported inclusive of any Mineral Reserves;  
 4. Grade represents estimated contained metal in the ground and has not been adjusted for metallurgical recovery; and  
 5. Numbers may not add due to rounding.

**Table 14.15: Audited Mineral Resource Statement for Neves-Corvo Zinc Zones  
 Wardell Armstrong International (WAI), effective December 31, 2022**

Resource Classification	Tonnage (kt)	Grade				Metal			
		Cu (%)	Zn (%)	Pb (%)	Ag (g/t)	Cu (kt)	Zn (kt)	Pb (kt)	Ag (Koz)
Measured	9,615	0.3	7.7	1.7	66	32	745	165	20,412
Indicated	55,486	0.3	6.7	1.4	60	186	3,693	751	106,895
<b>Measured + Indicated</b>	<b>65,101</b>	<b>0.3</b>	<b>6.8</b>	<b>1.4</b>	<b>61</b>	<b>219</b>	<b>4,437</b>	<b>917</b>	<b>127,306</b>
Inferred	3,897	0.3	5.7	1.6	64	13	223	62	8,028

Notes:  
 1. Mineral Resources are reported at a cut-off grade of 4.5% Zn  
 2. Mineral Resources are not reserves until they have demonstrated economic viability based on a feasibility study or pre-feasibility study;  
 3. Mineral Resources are reported inclusive of any Mineral Reserves;  
 4. Grade represents estimated contained metal in the ground and has not been adjusted for metallurgical recovery; and  
 5. Numbers may not add due to rounding.

**Table 14.16: Audited Mineral Resource Statement for Semblana Copper Zones  
 Wardell Armstrong International (WAI), effective December 31, 2022**

Resource Classification	Tonnage (kt)	Grade				Metal			
		Cu (%)	Zn (%)	Pb (%)	Ag (g/t)	Cu (kt)	Zn (kt)	Pb (kt)	Ag (Koz)
Inferred	7,807	2.9	-	-	25	223	-	-	6,299

Notes:  
 1. Mineral Resources are reported at a cut-off grade of 1.0% Cu  
 2. Mineral Resources are not reserves until they have demonstrated economic viability based on a feasibility study or pre-feasibility study;  
 3. Mineral Resources are reported inclusive of any Mineral Reserves;  
 4. Grade represents estimated contained metal in the ground and has not been adjusted for metallurgical recovery; and  
 5. Numbers may not add due to rounding.

## 15 MINERAL RESERVE ESTIMATES

The Mineral Reserve estimates detailed in the Technical Report were prepared in accordance with CIM Standards. The authors have reviewed the Mineral Reserve estimation methodology, including mine design, operational factors, life of mine production scheduling, and confirmation of a positive financial analysis.

Mineral Reserves are reported for the following zones: Neves North, Neves South, Corvo, Graça, Zambujal, Lombador Phase 1 (North and South) and Lombador Phase 2 (North and South).

Semblana and Monte Branco comprise of only Inferred Mineral Resources and as such are not considered within the Mineral Reserve estimate.

The mining methods used throughout Neves-Corvo are well understood and have been in operation over some 25 years of mining at the site, with continuous development and upgrading of methodologies as understanding of the orebodies has improved with time. In summary, the following mining methods are in use at the site and form the basis of the mine design, scheduling and Mineral Reserve estimation process:

- Drift & Fill
- Bench & Fill
- Optimised Bench & Fill (OBF)
- Mini Bench & Fill (MBF)
- Uphole Bench & Fill (UHF)
- Sill Pillar Recovery

These methods are described further in Section 16.

### 15.1 Mining Cut-Off

Due to the polymetallic nature of the orebodies, SOMINCOR utilises a NSR calculation to determine the value of each individual stope or stope block. The NSR is calculated based on metal prices, payable metals considering copper, lead, zinc and silver grades, metallurgical recoveries, and realisation costs.

Metal prices used in the calculation of NSR are shown in Table 15.1.

<b>Metal</b>	<b>Price</b>
Zinc	\$1.15/lb
Lead	\$0.90/lb
Copper	\$3.35/lb
Silver (stream contract)	\$4.40/oz



The mine operates using a range of COVs taking into consideration the wide range of operational costs for differing areas of the mine which vary significantly due to differences in mining method, support requirements, ventilation, working time and materials handling variation.

The NSR Cut-off Values are based on budget operating costs for mine, mill and G&A, plus sustaining capital expenditures estimates. Separate values are calculated for copper and zinc ores, to reflect different processing costs, but also to account for differences in terms of cut-off grade optimization: full costs are used for zinc ore, while for copper not all fixed costs are included, to keep the processing plant full.

Mining costs vary according to the mining method, haulage distances and capital mine development requirements. Table 15.2 summarizes the cost element inputs used to derive the COVs used in the Mineral Reserve estimate.

<b>Table 15.2: Cut-Off Values – Cost Element Inputs</b>					
<b>Cost Element</b>	<b>Mining Method</b>				
	<b>Drift &amp; Fill</b>	<b>Bench &amp; Fill</b>	<b>Mini Bench &amp; Fill</b>	<b>Optimised Bench &amp; Fill</b>	<b>Uphole Bench &amp; Fill</b>
Mining Cost, €/t	33.20	27.65	30.15	22.55	23.55
+ hauling cost, €/t/km	1.55	1.55	1.55	1.55	1.55
+ capital mine development (average), €/t	3.90	3.90	3.90	3.90	3.90
	<b>Copper</b>	<b>Zinc</b>			
Mill, €/t	6.70	10.30			
G&A, €/t	4.20	7.85			
Sustaining Capital, €/t	5.40	5.40			

## 15.2 Dilution

Mining dilution is applied to excavations on the basis of development profile and stope dimensions. Total stope dilution includes overbreak from backfill and mined out area and Inferred Mineral Resources and material below COV inside the stope design.

Total diluted stope tonnage is defined and calculated follows:

$$\text{Diluted Stope Tonnage} = \text{Stope Tonnes (STT)} + \text{Backfill Dilution Tonnes (BDT)} + \text{Inferred Resource Dilution (IFD)}$$

Where:

- Stope Tonnage (STT) = Stope tonnage from designed solid (all material inside solid with density from block model – includes material below COV).
- Backfill Dilution Tones (BDT) = (ETD + ITD) \* 2.4t/m<sup>3</sup>.

- Inferred resource dilution (IFD) – Any inferred resource tonnage included inside the stope was considered with zero grade.

And:

- External dilution (ETD)– Based on thickness of backfill from floor and sidewall.
- Internal dilution (ITD) – Intersection volume between designed stopes and the mined out.

Dilution factors used in the Mineral Reserve evaluation are shown in Table 15.3.

Stope Type	Profile	Height (m)	Width (m)	Dilution Factor	Type
Hybrid	B1	20	12	8.8%	Bench
Hybrid	B2	20	10	10.0%	
Hybrid	B3	20	8	11.9%	
Hybrid	B4	20	15	7.5%	
Hybrid	B5	20	5	17.5%	
Hybrid	B6	20	6	15.0%	
Hybrid	B7	20	4.5	19.2%	
Hybrid	B8	20	18	6.7%	
Hybrid	M4	4.5	5	12.7%	Drifts
Hybrid	M5	5	5	12.0%	
Hybrid	M6	6	5	11.0%	
Hybrid	M7	7	5	10.3%	
Hybrid	S1	1	5	30.0%	Floor
Hybrid	S2	2	5	17.5%	
Hybrid	S3	3	5	13.3%	
Hybrid	S4	4	5	11.3%	
Hybrid	T1	1	5	30.0%	Back/Roof
Hybrid	T2	2	5	17.5%	
Hybrid	T3	3	5	13.3%	
Hybrid	T4	4	5	11.3%	

### 15.3 Mining Recovery

Mining recovery factors are applied as follows:

- D&F stopes – 95% of diluted tonnage recovered;
- B&F and MBF stopes - 95% of diluted tonnage recovered; and
- OBF and UHF stopes - 90% of diluted tonnage recovered.

As such:

$$\text{Recovered Tonnage} = \text{Diluted Stope Tonnage (DiStTo)} \times \text{Recovery Factor}$$

### 15.4 Design Process

Mine design and scheduling works are carried out using the Deswick Software suite and follow a defined process which conforms to industry best practice for the estimation of Mineral Reserves.

Stope locations are identified using mineable stope optimiser (MSO), with final stope designs augmented by manual checks and verifications. Development headings are designed manually according to mining method and location.

All stope areas are designed based upon average block NSR values, with NSR calculations provided by LMC's Corporate Business Analyst and incorporated into the Mineral Resource block models prior to commencement of the mine design stage.

The planning process methodology for the estimation of Mineral Reserves is detailed below.

Stopes are designed using a combination of MSO and manual stope/development design. The design basis is driven by the COVs defined above, in conjunction with the geotechnical parameters defining maximum stope dimensions, selected mining method and block value.

MSO provides a stope shape that maximises the recovered Mineral Resource value above a cut-off while also catering for practical mining parameters such as; minimum and maximum mining width, anticipated wall dilutions, minimum and maximum wall angles, minimum separation distances between parallel and/or sub-parallel stopes, minimum and maximum stope heights and widths, separation of ore types. Mineable shapes are defined against the Mineral Resource block models, based on the NSR break even cut-off values and Mineral Resource classification. Stopes are classified as either copper or zinc stopes, based on the economic value.

Dilution factors, including consideration of dilution from backfill and dilution by Inferred Mineral Resources, treated as zero-grade waste, are subsequently applied to the mineable shapes with a diluted stope grade calculated for each stope within the design. Stopes which have an average NSR value below the appropriate COV are then excluded from the design and scheduling process.

Stopes which achieve the appropriate NSR are then processed in Deswick to calculate design quantities, including application of Mining Recovery factors, to define the Proven and Probable tonnes and grade within the Mineral Reserve.

### **15.5 Mineral Reserve Statement**

The Mineral Reserve estimate for the Neves-Corvo deposit is classified in accordance with the CIM Definition Standards for Mineral Resources and Mineral Reserves (2014). Mineral Reserves are derived from Measured or Indicated Mineral Resources after applying economic parameters. Mineral Reserves are classified using the following criteria:

- Proven Mineral Reserves are the Measured Mineral Resources where development work for mining and information on processing/metallurgy and other relevant factors demonstrate that economic extraction is achievable.

- Probable Mineral Reserves are those Measured and Indicated Mineral Resources where development work for mining and information on processing/metallurgy and other relevant factors demonstrate that economic extraction is achievable.

The audited Mineral Reserve statement for Neves-Corvo is shown in Table 15.4. The effective date of the Mineral Reserve estimate is December 31, 2022.

The stated Mineral Reserves are not materially affected by any known environmental, permitting, legal, title, taxation, socio-economic, marketing, political or other relevant issues, to the best knowledge of the author. There are no known mining, metallurgical, infrastructure, or other factors that materially affect this Mineral Reserve estimate, at this time.

<b>Table 15.4: Audited Mineral Reserve Statement for Neves-Corvo Wardell Armstrong International (WAI), effective December 31, 2022</b>									
<b>Copper Zones</b>									
<b>Reserve Classification</b>	<b>Tonnage (kt)</b>	<b>Grade</b>				<b>Contained Metal</b>			
		<b>Cu (%)</b>	<b>Zn (%)</b>	<b>Pb (%)</b>	<b>Ag (g/t)</b>	<b>Cu (kt)</b>	<b>Zn (kt)</b>	<b>Pb (kt)</b>	<b>Ag (Koz)</b>
Proven	3,095	3.2	0.6	0.2	33	99	19	5	3,254
Probable	18,112	1.9	0.6	0.2	33	339	117	42	19,390
<b>Proven + Probable</b>	<b>21,207</b>	<b>2.1</b>	<b>0.6</b>	<b>0.2</b>	<b>33</b>	<b>438</b>	<b>135</b>	<b>47</b>	<b>22,644</b>
<b>Zinc Zones</b>									
<b>Reserve Classification</b>	<b>Tonnage (kt)</b>	<b>Grade</b>				<b>Contained Metal</b>			
		<b>Cu (%)</b>	<b>Zn (%)</b>	<b>Pb (%)</b>	<b>Ag (g/t)</b>	<b>Cu (kt)</b>	<b>Zn (kt)</b>	<b>Pb (kt)</b>	<b>Ag (Koz)</b>
Proven	3,369	0.3	8.1	2.1	69	11	274	72	7,518
Probable	18,930	0.3	7.4	1.6	62	62	1,393	311	37,603
<b>Proven + Probable</b>	<b>22,299</b>	<b>0.3</b>	<b>7.5</b>	<b>1.7</b>	<b>63</b>	<b>73</b>	<b>1,667</b>	<b>383</b>	<b>45,121</b>
Notes:									
1. Mineral Reserves are reported using a cut-off based on a NSR breakeven price which averages from €44-60/t depending on mining areas and stoping methods;									
2. Metal prices used in the NSR evaluation are US\$3.35/lb for copper, US\$1.15/lb for zinc, US\$0.90/lb for lead. A silver price of US\$4.40/oz is used in the calculation of NSR to reflect the contract to Wheaton Precious Metals Corp;									
3. Mining, processing and administrative costs were estimated based on actual costs; and									
4. Numbers may not add due to rounding.									

## **16 MINING METHODS**

### **16.1 Overview of Mining Operations**

#### **16.1.1 Introduction**

Underground mining at Neves-Corvo has been continuously conducted since 1988. The current production plan for 2023 is budgeted at 2.7Mt of copper ore at a grade of 1.8% Cu and 2.0Mt of zinc ore at a grade of 6.9% Zn. Zinc production is projected to increase to 2.5Mtpa from 2024. The current life of mine plan runs to 2032. The final year of full production is 2028. In the life of mine plan, total hoisted rock (ore plus waste) ranges from 5.4Mtpa to 5.9Mtpa.

#### **16.1.2 Elevation Datum and Nomenclature**

The surface topography of the mine site features undulating hills, with variable elevation. Surface elevation at the main, Santa Barbara, shaft is approximately 220m above local mean sea level. The mine elevation datum is offset by 1,000m from sea level, and as such the surface elevation is quoted as 1220 Level according to mine datum.

All other mining level nomenclature follows this system for example, the 700 Level is 700m above mine datum at a depth of circa 520m below surface.

#### **16.1.3 General Information**

The Neves-Corvo mine currently produces ore from five sectors: Corvo, Lombador South & North, Graca, Neves South & North and Zambujal. Lombador is the largest sector that contains more than 65% of the current Mineral Reserves, followed by Neves, Corvo, Zambujal and Graca. The smallest Graca sector will be mined out in 2028.

The main loading and hauling equipment used in the mine are diesel powered LHDs and Trucks for both production and development. Conventional electro-hydraulic drill rigs are used for drifting and stope production drilling.

The mine has five fully equipped underground workshops for mobile and fixed plant repair situated at the 810, 700, 590, 550 and 380 Levels and plans to build an additional workshop at the 220 Level (for LP2).

The mine operates on a two-shift per day basis, with shifts of 10 hours, 42 minutes in duration (the maximum permitted under Portuguese law). Labour and equipment requirements are based on an assumed 720 shifts per annum basis.

The mining department has at present a total of 700 staff in production, development services, maintenance, engineering, planning, rock mechanics, geology, and exploration. On day shift there are up to 300 persons underground.

#### **16.1.4 Access and Ore Handling**

The mine is accessed by two primary routes:

- Santa Barbara Shaft: a 5m diameter circular concrete-lined shaft situated to the west of the main Corvo orebody. The shaft is 600m deep and extends marginally beyond the 700 Level; it is equipped with rope guides, a 2.5MW double drum winder and two 17.8t (wet load) capacity skips. Current peak capacity of the shaft has been established at 5.4Mtpa.
- Corvo Decline: the main access decline from surface has been developed at an average gradient of 17%, has a cross sectional area of 18m<sup>2</sup> and provides vehicular access to the mine. This ramp handles all the movement of men and equipment in and out of the mine. Additional internal ramps have been developed within the mine to access the various orebodies and carry out exploration development.

The upper underground crusher station is located at the 700 Level and used to crush ore and waste from the Upper Corvo, Neves, Zambujal and Graça orebodies. This facility has four 1,500t capacity storage bins and a jaw crusher capable of handling up to 600t/hr.

A second crusher at the 550 Level services the section of the mine which extends from the 700 Level to below the 550 Level. This currently crushes ore from Lower Corvo and Lombador, into three storage bins. Material from the storage silos feeds onto a short sacrificial conveyor and subsequently to the TP12 inclined conveyor, which delivers the crushed material to the 700 Level bins. This system also has an installed capacity of 600t/hr.

A new crusher-conveyor rock handling system (the 260 Crusher) has been installed as part of the ZEP in the footwall of the Lombador orebody at approximately 260 Level between the northern and southern mine areas. Ramps extend into the two mine areas (Lombador South and Lombador North), with trucks from both ramps tipping into the 260 Level Crusher. The 260 Level Crusher has a nominal and peak capacity of 555t/hr and 666t/hr, respectively. Crushed rock is conveyed from the 260 Level Crusher bins to the two 700 Level bins for hoisting to surface via the Santa Barbara Shaft.

A schematic of the ore haulage system is presented in Figure 16.1, whilst overall views of the mine and orebody layout are provided in Figure 16.2 and Figure 16.3.

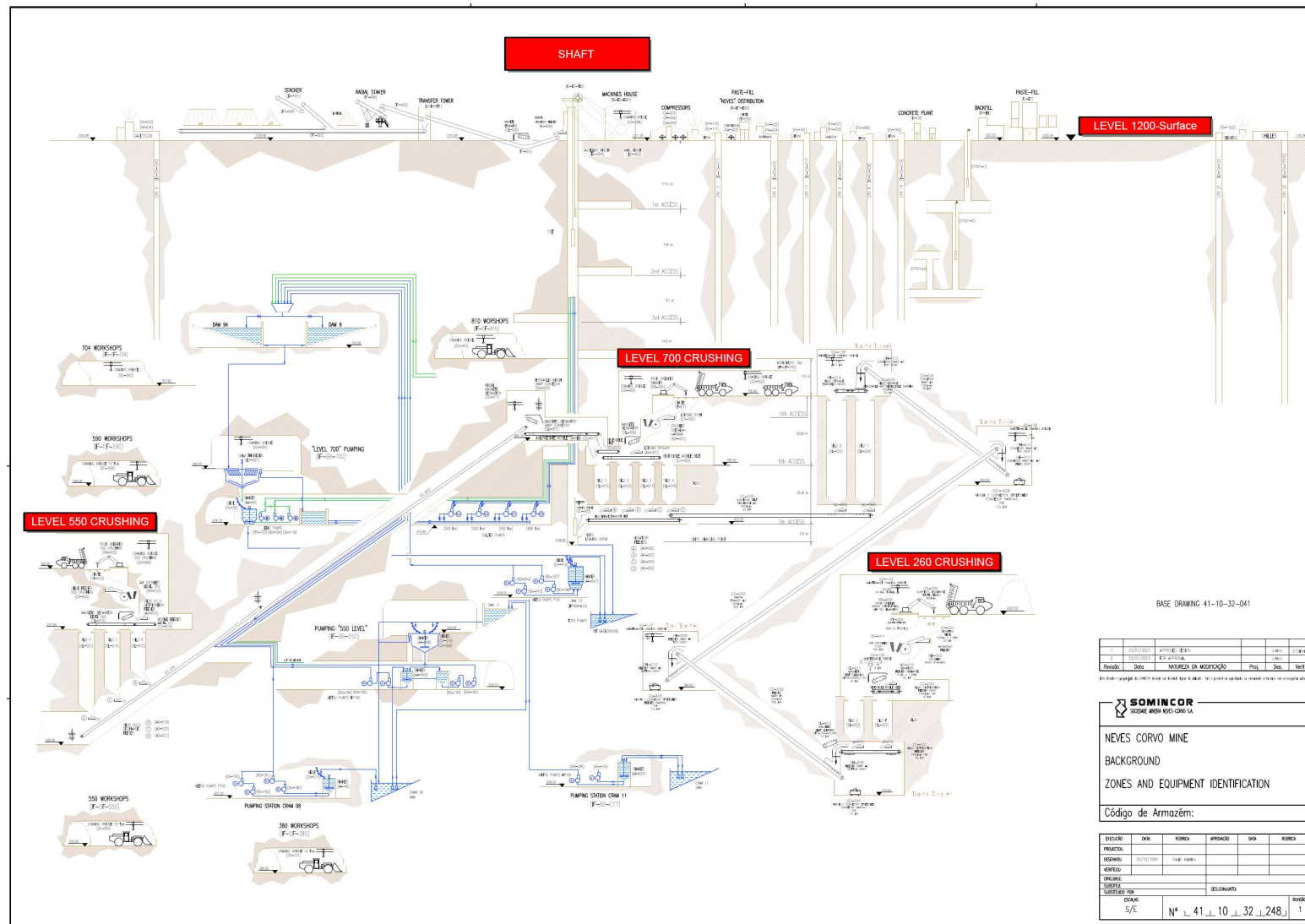
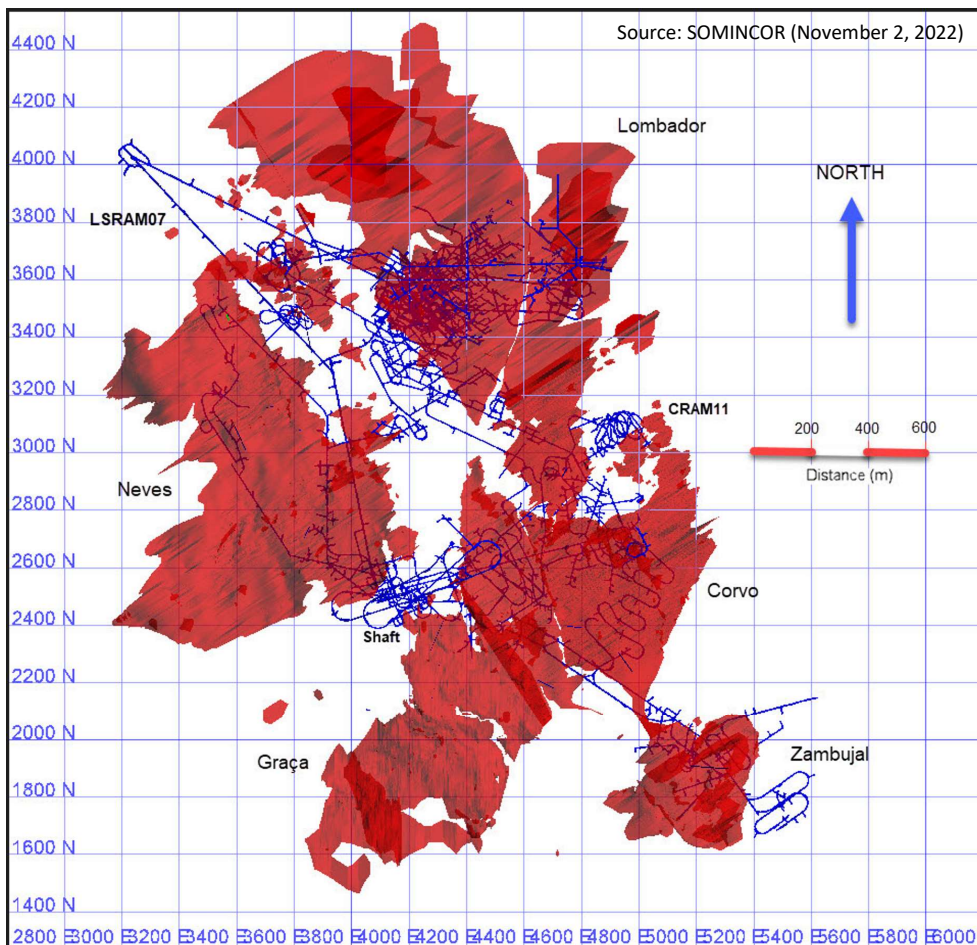
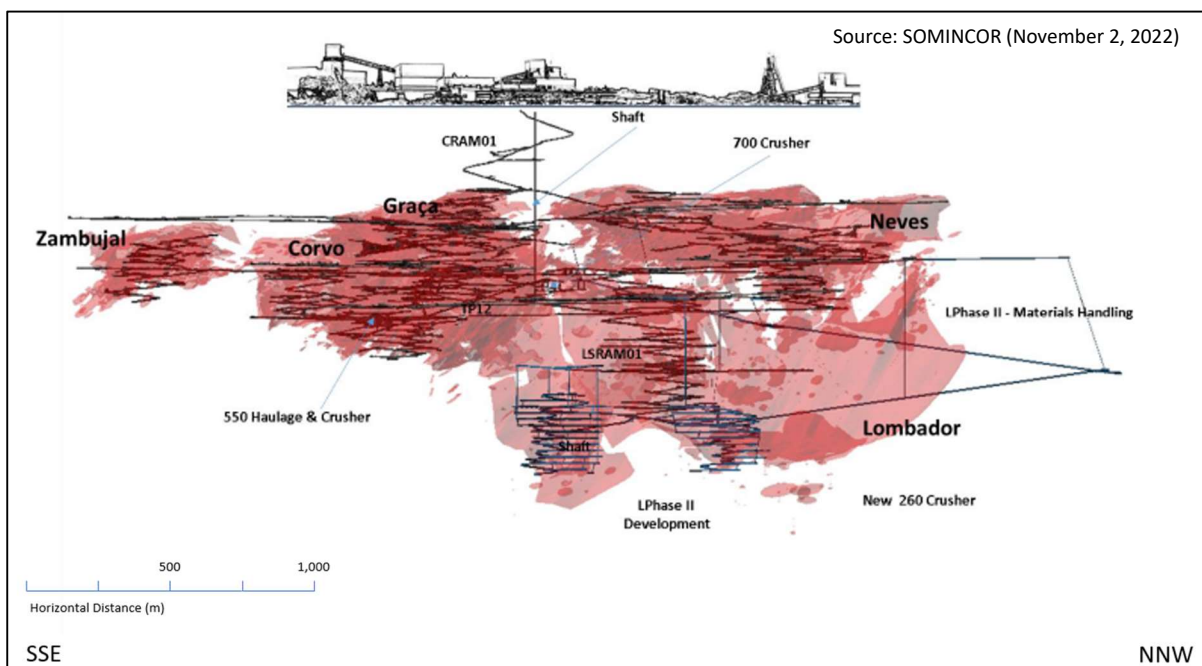

Figure 16.1: Ore Handling System Schematic



**Figure 16.2: Plan View Showing Neves-Corvo Orebodies**



**Figure 16.3: Vertical Section Showing Neves-Corvo Orebodies**



## 16.2 Stopping Methods

### 16.2.1 Overview

The mining methods used throughout Neves-Corvo are well understood and have been in operation for over 25 years of mining at the site, with continuous development and upgrading of methodologies as understanding of the orebodies has improved with time.

Drift-and-fill (D&F) and bench-and-fill (B&F) stopping are the primary methods in operation at the site. Both of these methods have been well adapted and tailored to the large but locally complex high-grade ores present throughout the operations, with variations of Optimised B&F (OBF), Mini B&F (MBF) and Underhand Fill (UHF) employed as required.

### 16.2.2 Drift-and-Fill

Drift-and-fill was the original mining method selected for Neves-Corvo. Although the method has relatively low productivity rates and high unit costs, it was chosen because it is highly flexible and can achieve high recovery rates in high grade orebodies with complex and flat dipping geometries. The initial copper Mineral Reserves at Neves-Corvo, largely in the Graça and Upper Corvo orebodies, averaged in excess of 8.0% Cu and it was important to select a method that extracted all of this high-grade mineralisation. Figure 16.4 shows the typical drift-and-fill layouts used at the mine.

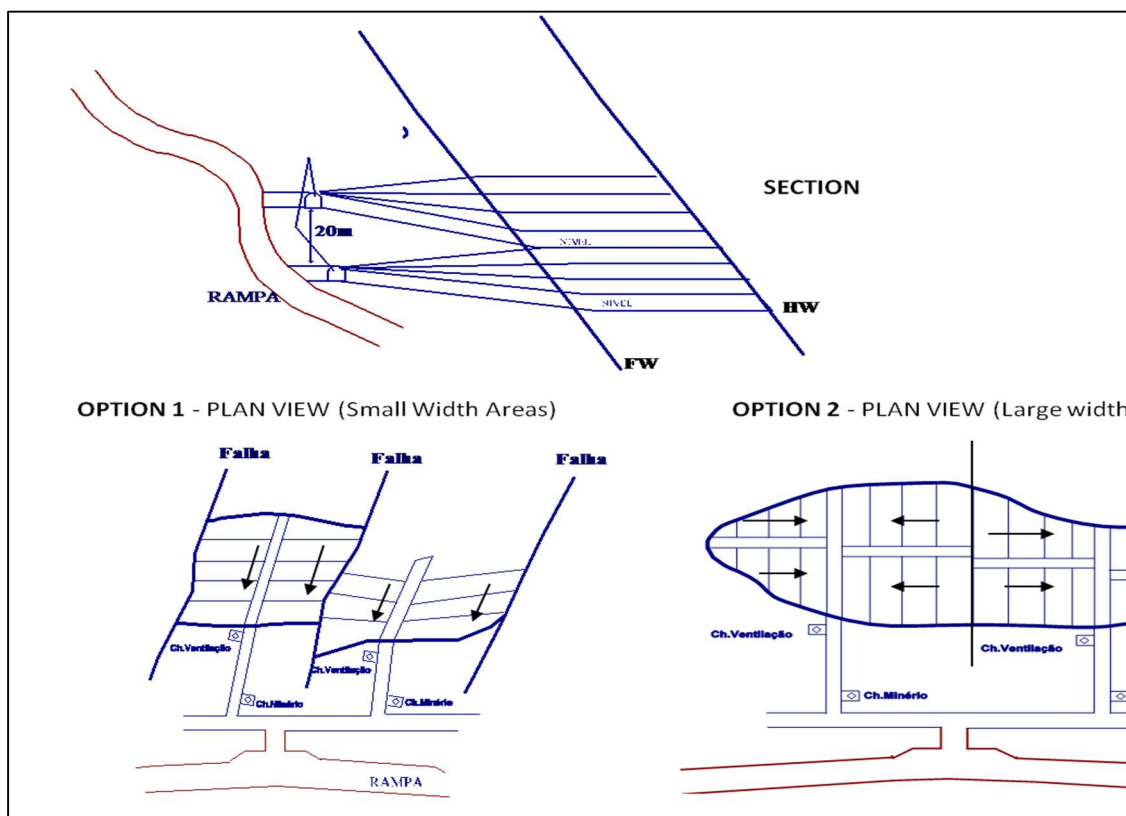

Figure 16.4: Typical Drift-and-Fill Mining Layouts used at Neves-Corvo

Drift-and-fill stopes at Neves-Corvo are normally accessed from a footwall ramp with footwall access drives driven along the orebody strike at 20m vertical intervals. Access crosscuts are driven down from the footwall access drives into the orebody. A horizontal slice is subsequently mined using drifts developed either longitudinally or transversely in sequence. Standard drift dimensions are 5.0m x 5.0m, with the sidewalls often being slashed before backfilling. Following completion of a drift it is tightly backfilled with hydraulic sand fill or paste fill before the drift alongside is mined. When a complete 5m high orebody slice is mined and filled, the back of the access drive is “slashed” down and mining recommences on the level above.

Drift-and-Fill is generally applied to areas of the mine with a mining thickness of less than 10m and has become the prevalent mining method at Neves-Corvo as the thicker parts of the orebodies that are more suitable for bench and fill mining have become depleted.

### 16.2.3 Bench and Fill

The bench-and-fill mining method has been used extensively at Neves-Corvo in areas where the mineralisation is of sufficient thickness and continuity. The method is more productive and has lower operating costs than that of DF method. The method is generally applied in areas of the orebodies greater than 20m in vertical thickness.

Bench-and-fill stopes are also accessed from a footwall ramp, with footwall drives driven along strike in waste at 20m vertical intervals. Upper and lower access crosscuts are driven across the orebody to the hangingwall contact, as shown in Figure 16.5.

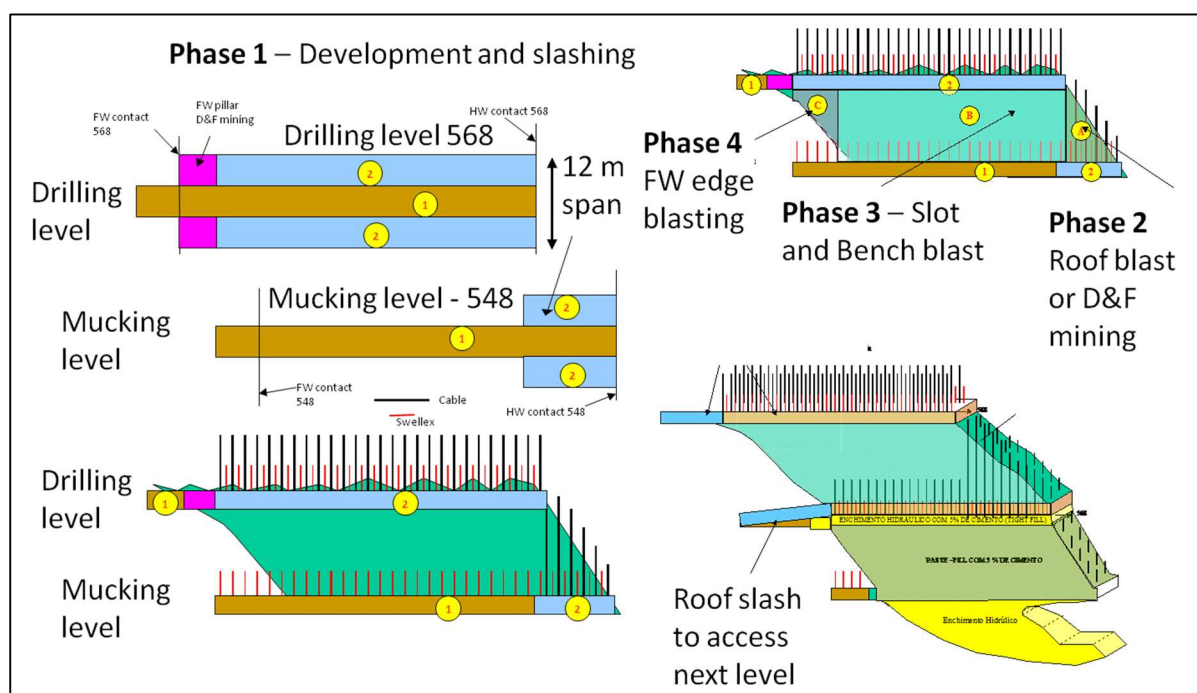

Figure 16.5: Bench-and-Fill Mining Method (Schematic)

The top access is normally opened to a 12m stope width and appropriate support installed, including cablebolts and shotcrete as required. Primary support is Swellex. A slot raise is opened at the hangingwall end of the stope and is then enlarged, providing free face for the whole width of the stope. Vertical rings of large diameter drillholes are then drilled and blasted on retreat to the footwall. Loading of the broken ore takes place from the lower access using remote-controlled load-haul-dump vehicles.

Primary BF stopes have been mined up to 120m long, but secondary stopes are more typically broken in to 30 to 40m across-dip lengths before being backfilled. The stopes are normally mined in an up-dip primary-secondary sequence. Primary stopes are normally filled with cemented paste fill and then tightly filled with hydraulic sand fill. Secondary stopes are filled with either waste rock or low cement paste fill and then also tight filled with hydraulic sand fill, with the exception being in the Lombador area, where hydraulic fill has not been used.

Following the satisfactory completion of the backfilling process for each BF stope, the back of the former drilling level is slashed out to establish a new mucking level for the next stope above.

More recently, the BF mining method has been modified slightly in some areas by no longer slashing out the backs of former drilling levels when creating subsequent mucking levels. Instead, mucking levels are created by mining through or on-top of the in-situ backfill in the drill drives and re-establishing the existing excavation.

#### **16.2.4 Mini Bench-and-Fill**

Mini bench-and-fill (MBF) is a hybrid method providing greater productivity than conventional drift-and-fill where orebody thicknesses are between 10-15m. Accesses are again developed in the footwall via ramps and footwall drives. In mini bench-and-fill, drilling and mucking take place on different horizons but from opposing ends with crosscuts 5m to 10m apart vertically, as shown in Figure 16.6.

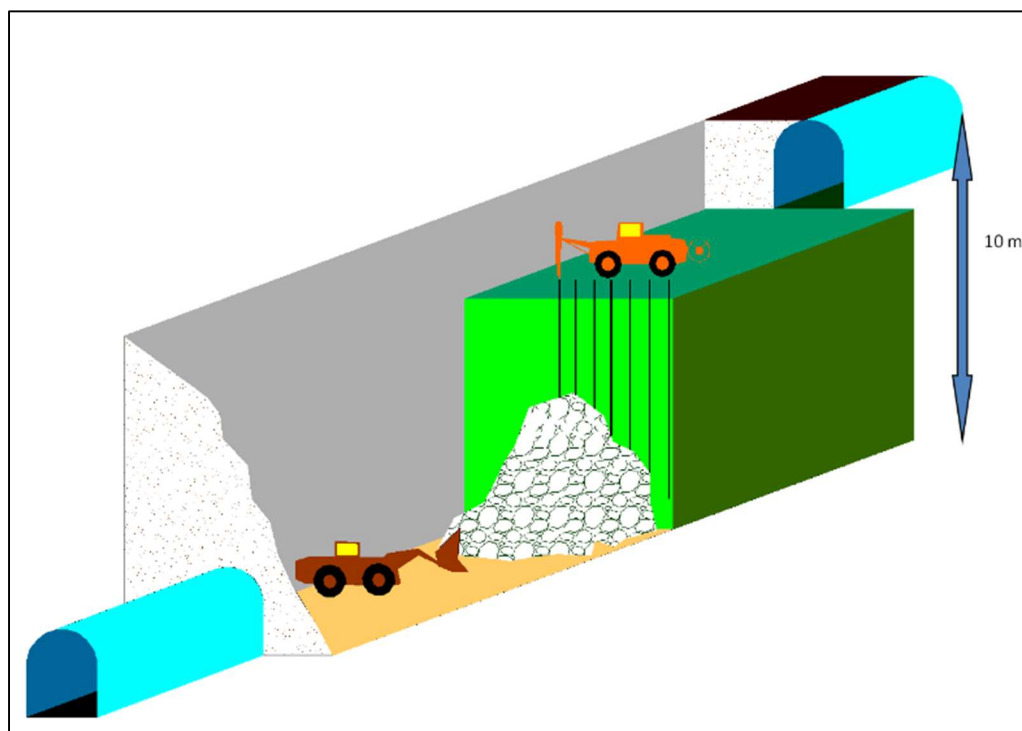

**Figure 16.6: Mini Bench-and-Fill Mining Method (Schematic)**

Unlike BF, MBF stopes are sometimes mined along strike. Typically, 5.0m x 5.0m drifts from the upper crosscut are mined along strike until they reach the back of the lower crosscut (usually 40m), and they break through to form a drawpoint. Vertical holes are then drilled and blasted in retreat from the drawpoint back to the upper crosscut, with mucking taking place via the lower crosscut. Mini bench-and-fill stopes are normally mined in a primary-secondary sequence, with tight filling achieved using hydraulic sand fill.

### **16.2.5 Optimised Bench-and-fill**

Optimised Bench-and-Fill was developed to benefit from the competent massive sulphide hosted (MZ) ore and obtain a lower cost mining method with similar recovery rates of BF. Optimised Bench-and-Fill presents significantly less geotechnical challenges than a traditional stacked bench or Long-Hole-Open-Stopping (LHOS) solution, while maintaining high levels of mining recovery and lower operating costs than the traditional Neves-Corvo BF.

Optimised Bench-and-Fill has been successfully implemented in Lombador Phase 1 (LP1) and later in other Neves-Corvo orebodies. This method is described below and is also the primary method of extraction for Lombador Phase 2 (LP2).

The OBF mining method is a bottom-up method utilising transverse stopes accessed from footwall ramps and crosscuts. It involves the initial extraction of primary stopes followed by backfilling and subsequent extraction of secondary stopes formed between the previously mined and paste filled primary stopes. Primary and secondary stopes will be 15m wide by 20m high and will vary in length

depending on the width of the orebody. The primary and secondary stope extraction is completed before production starts on the next level above and is shown in Figure 16.7.

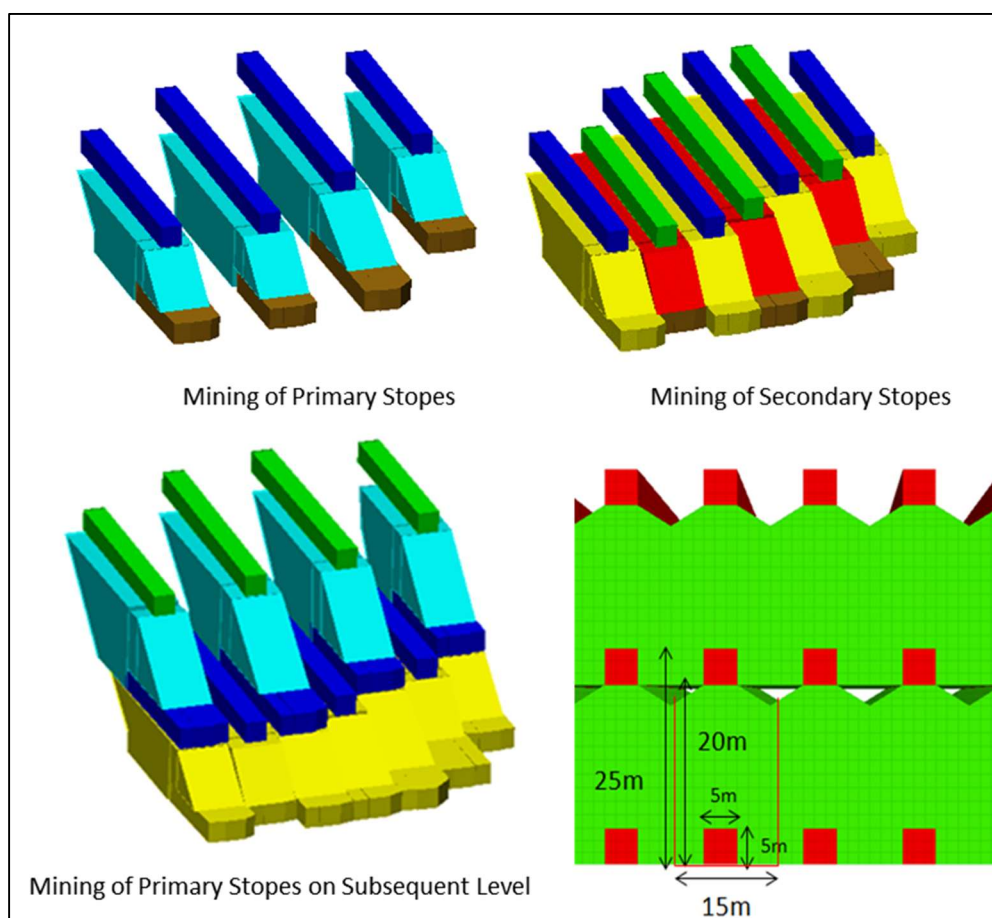

**Figure 16.7: Optimized Bench-and-Fill Mining Method (Schematic)**

### 16.2.6 Uphole Bench & Fill (UHF)

The UHF method has been utilized since 2019, primarily in areas with good geotechnical conditions and orebody thickness greater than 18m. The UHF method requires only a single 5m x 5m bottom access, used for both drilling and removal operations. The method uses an up-hole ring drilling scheme and holes to backfill, with UHF stopes normally 12m wide and with height that will vary depending on the orebody geometry. The UHF mining method is shown in Figure 16.8.

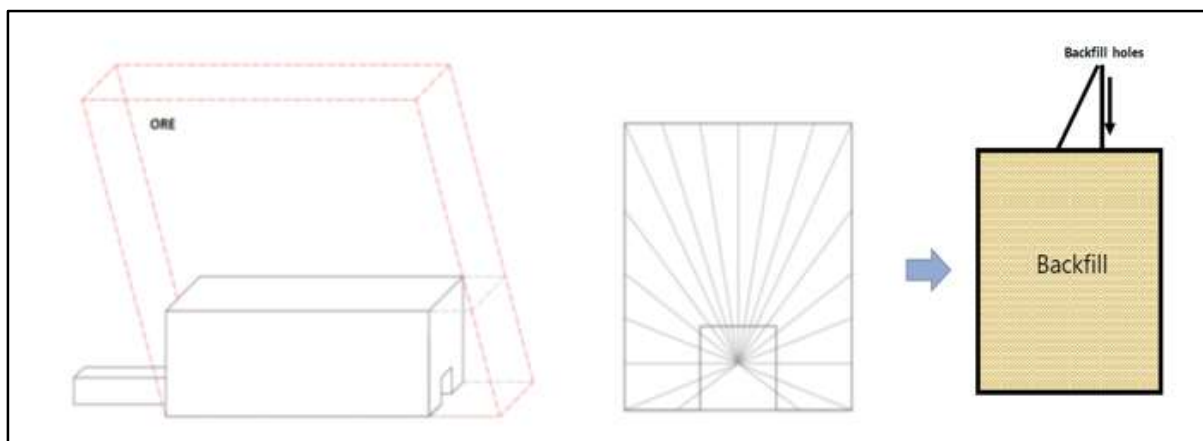
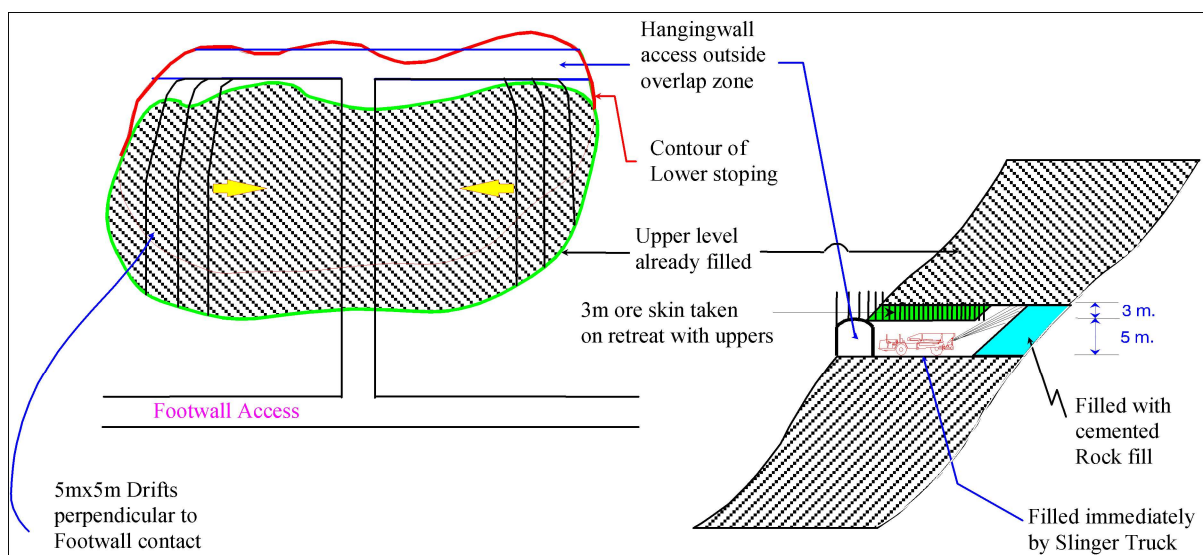

**Figure 16.8: UHF Mining Method (Schematic)**

### 16.2.7 Sill Recovery

A sill recovery method has been developed at Neves-Corvo to extract the ore remaining in sill pillars created between up-dip mining panels.

From the footwall access a central crosscut is developed through the orebody to the hangingwall and is heavily supported with cablebolts breaking into the fill above, close pattern rockbolting and shotcrete. A hangingwall access is then driven along the strike of the orebody outside the overlying backfill and from this drive crosscutting drifts are developed to the footwall contact, as shown in Figure 16.9.



**Figure 16.9: Sill Recovery Mining Method (Schematic)**

This final 8m thick slice beneath the overlying backfill is removed in two stages, one slice of 5m when the normal drift is developed in advance and then a final 3m slice, which is blasted down from the roof of this drift in retreat. This final slice is slashed off the back and rapidly backfilled using CRF applied with a slinger truck to fill achieve as tight a fill as possible from a safe, remote position. Successive

crosscutting drifts are then mined back to the central access drive accordingly. Up to 95% mining recovery of some high-grade sill pillars has been achieved using this method. The sill recovery method has not been used in recent years.

### 16.3 Life of Mine Schedule

The optimised life of mine schedule used for the derivation of Mineral Reserves was prepared in Deswik Scheduler by applying maximum stope, panel and level production rates to the designed stopes and development headings.

The resultant mining schedule is presented in Table 16.1. The total materials scheduled in the LOM plan contain approximately 2.0Mt of additional material compared to the values stated in the Mineral Reserves. The differences are due to variances in the actual production versus forecast in year 2022. The authors do not believe that this change is material to the LOM plan or Mineral Reserve Estimate.

		2023	2024	2025	2026	2027	2028	2029	2030	2031	2032
Total Ore Hoisted	Mt	4.66	5.20	5.20	5.20	5.29	5.22	4.39	4.28	3.92	2.24
Total Waste Hoisted	Mt	0.74	0.64	0.34	0.29	0.66	0.36	0.00	0.00	0.00	0.00
Total Material Hoisted	Mt	5.40	5.84	5.54	5.49	5.94	5.58	4.39	4.28	3.92	2.24
Massive Copper Ore	Mt	0.99	0.97	0.76	0.96	1.04	1.13	1.05	0.95	0.72	0.14
Massive Copper Cu Grade	%	2.1	2.4	2.3	2.2	2.4	2.0	2.2	2.0	2.0	3.5
Stockwork Copper Ore	Mt	1.67	1.73	1.94	1.74	1.75	1.59	0.84	0.89	0.70	0.32
Stockwork Copper Cu Grade	%	1.6	1.5	1.6	1.6	1.7	1.5	1.4	1.4	1.5	1.6
Zinc Ore	Mt	2.00	2.50	2.50	2.50	2.50	2.50	2.50	2.44	2.50	1.78
Zinc Ore Zn Grade	%	6.98	7.0	7.2	7.5	7.4	7.2	7.5	7.5	7.9	7.9

The life of mine schedule for copper and zinc ore is shown graphically in Figure 16.10 and Figure 16.11, respectively.

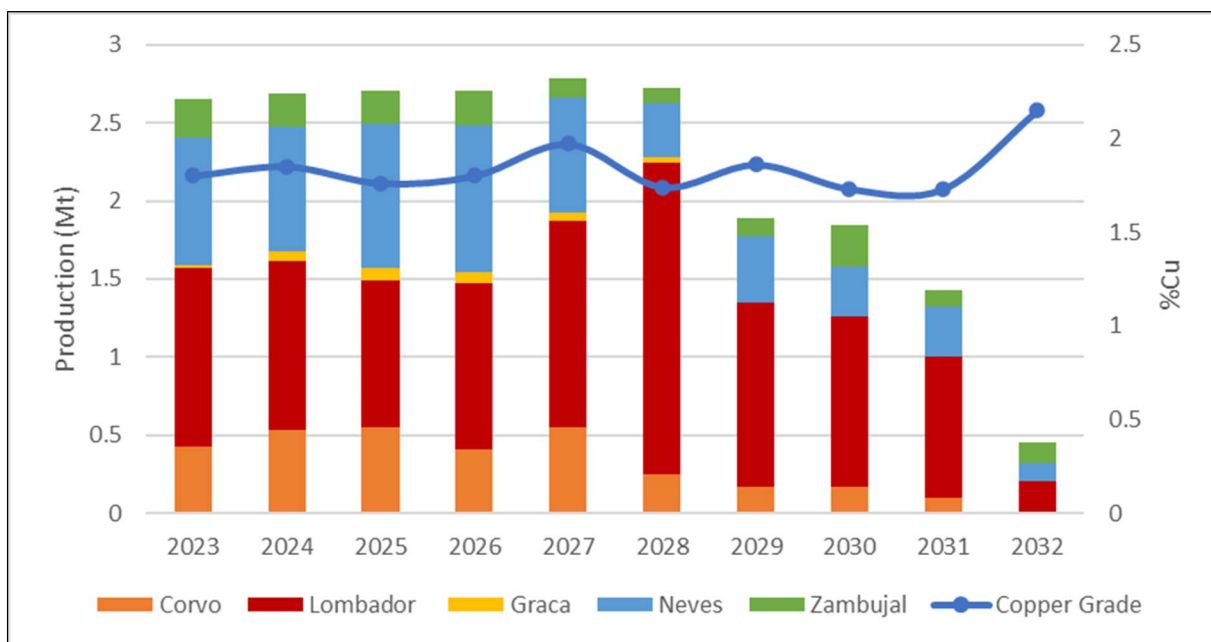

Figure 16.10: Copper Ore Feed Schedule

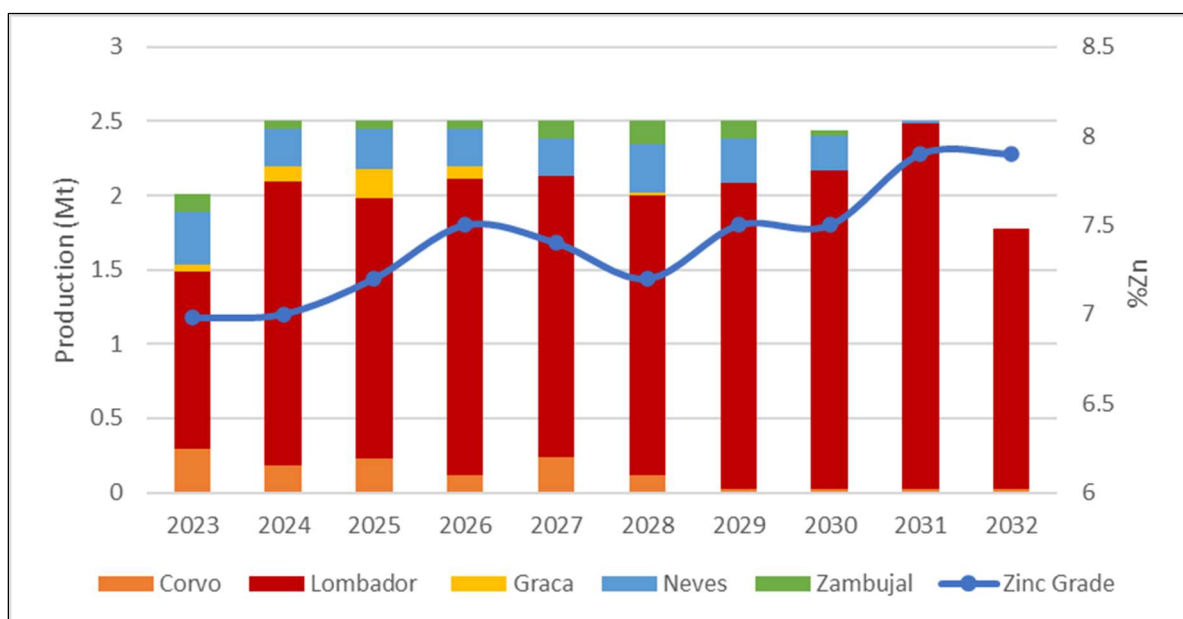

Figure 16.11: Zinc Ore Feed Schedule

## 16.4 Geotechnics & Rock Mechanics

### 16.4.1 Overview

Seven massive sulphide mineralised zones are present at Neves-Corvo and include: Neves, Corvo, Graça, Zambujal, Lombador, Monte Branco and Semblana. The deposits are found on both flanks of the Rosário-Neves-Corvo antiform, connected by thin "bridges" of massive sulphide at the highest point of the antiform in stratigraphical sequence. This has resulted in a complex and almost continuous



volume of mineralised rock with varied mineralisation styles and geological structures. The deposits are located at depths between 230m and 1,300m below surface. Neves, Corvo, Graça, Zambujal, Lombador are being actively mined, while no mining has taken place at Semblana or Monte Branco.

The rock mass classification for the most common rock types at Neves-Corvo, based on rock mass rating (RMR), Q-system (Q) and geological strength index (GSI) is shown in Table 16.2.

<b>Rock Type</b>	<b>RMR</b>	<b>Q</b>	<b>GSI</b>
Massive Zinc	II-III Good-Fair	Fair	Fair
Massive Copper	II-III Good-Fair	Fair	Fair
Stockwork	IV Poor	Poor	Poor
Ruban�	IV Poor	Poor	Poor
Volcanics	III Fair	Fair-Good	Fair-Good
Quartzite	III Fair	Poor-Fair	Poor-Fair
Shale	III-IV Fair-poor	Poor-Fair	Poor-Fair
Black Shale	IV-V Poor-Very Poor	Very Poor	Poor-Very Poor

The current mining methods have been in place for over 25 years and the ground conditions are well understood. Few changes have been made to the rock mass classification, excavation dimensions and support installation recommendations at the Neves-Corvo deposits with the exception of Lombador (and in particular LP2). Due to the depth and stress condition of the deposit, infrastructure development and mining is expected to be more challenging in this region, and a number of studies have been or are being undertaken to assess the suitability of the assigned design parameters, to assess the rock mass response to mining in this zone and recommend changes to development mining and support requirements. The geotechnical conditions at Lombador are detailed in the following sections.

## **16.4.2 Lombador Area**

### *16.4.2.1 Summary Descriptions*

The Lombador massive sulphides are found near the boundary of the PQ group and the VSC. The unit consists of massive sulphides located in the VSC and underlying stockworks located in the PQ group. Lower rock mass quality shale and black shale formations are present in both the PQ and the VSC. Adopted material parameters for each lithological unit in LP2 are summarised in Table 16.3.

**Table 16.3: LP2 Geotechnical Parameters (Mining One Consultants (2021))**

Parameter	Host Material	Quartzite	Volcanics	Black Shale	Shale	Carbonate Shale	Massive Pyrite	Faults
Density	3.5 t/m <sup>3</sup>	3.5 t/m <sup>3</sup>	3.5 t/m <sup>3</sup>	3.5 t/m <sup>3</sup>	3.5 t/m <sup>3</sup>	3.5 t/m <sup>3</sup>	3.5 t/m <sup>3</sup>	3.5 t/m <sup>3</sup>
Young's Modulus	35 GPa	68 GPa	68 GPa	35 GPa	35 GPa	35 GPa	130 GPa	35 GPa
UCS	80 MPa	100 MPa	100 MPa	80 MPa	80 MPa	80 MPa	150 MPa	N/A
m <sub>i</sub> max	8	10	10	8	8	8	20	N/A
m <sub>i</sub> min	4	5	5	4	4	4	N/A	N/A
Anisotropy Factor	2.5	2.5	2.5	2.5	2.5	2.5	N/A	N/A
Anisotropy Orientation	27°/57° + variable	27°/57° + variable	27°/57° + variable	27°/57° + variable	27°/57° + variable	27°/57° + variable	N/A	N/A
GSI	64	71	66	50	64	65	62	N/A
Cohesion	N/A	N/A	N/A	N/A	N/A	N/A	N/A	0.1 MPa
Residual Cohesion	0 MPa	0 MPa	0 MPa	0 MPa	0 MPa	0 MPa	0 MPa	0 MPa
Friction	N/A	N/A	N/A	N/A	N/A	N/A	N/A	30°
Residual Friction	45°	45°	45°	45°	45°	45°	45°	30°
Residual Tension	0 MPa	0 MPa	0 MPa	0 MPa	0 MPa	0 MPa	0 MPa	0 MPa
Dilation	N/A	N/A	N/A	N/A	N/A	N/A	N/A	5°
Crit Red	1	1	1	1	1	1	3	N/A

The regional structure is located on the eastern limb of a northwest trending antiform that is intersected by a system of north-south trending sub-vertical faults. The massive sulphide lenses are bounded by thrust faults on both the footwall and the hangingwall.

The structural data available for LP1 and the surrounding deposits have been used to determine the structure for LP2. The data sources consist of structural mapping carried out by SOMINCOR, Acoustic Televiewer survey data for a shaft in LP1 and mapping carried out by SRK (2015) in the deepest part of LP1. Major structural features including faults, contacts and shear zones were determined by mine geology based on diamond drillhole intersections. Stereonets for LP1 and LP2 are shown in Figure 16.12 and Figure 16.13, respectively.

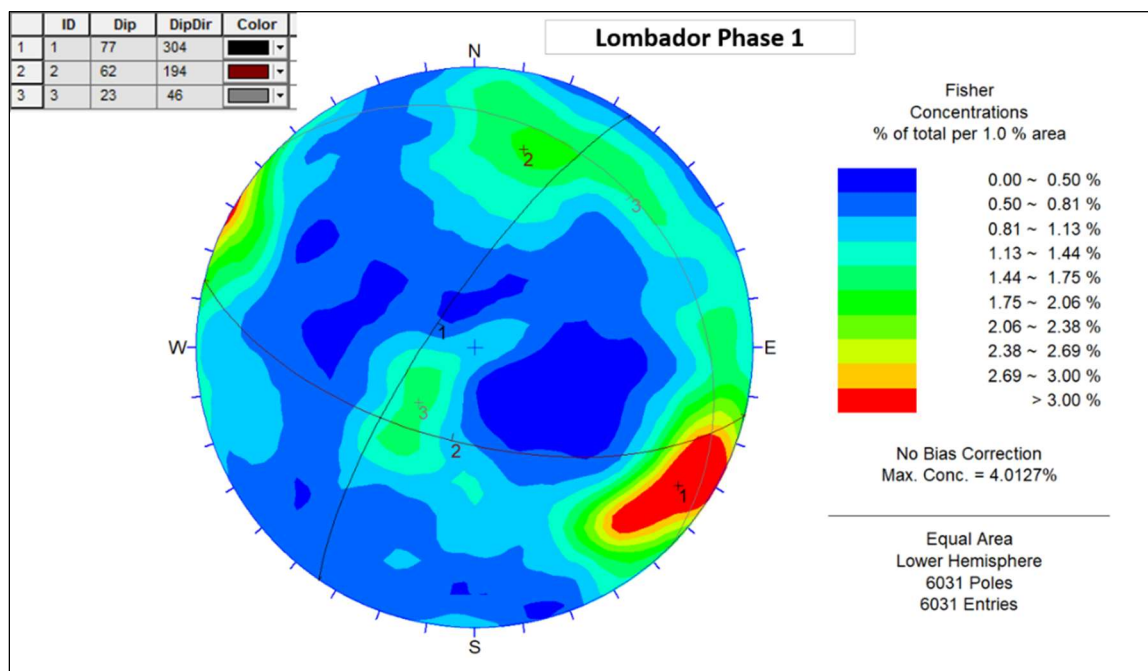

Figure 16.12 Lombador Phase 1 Joint Sets

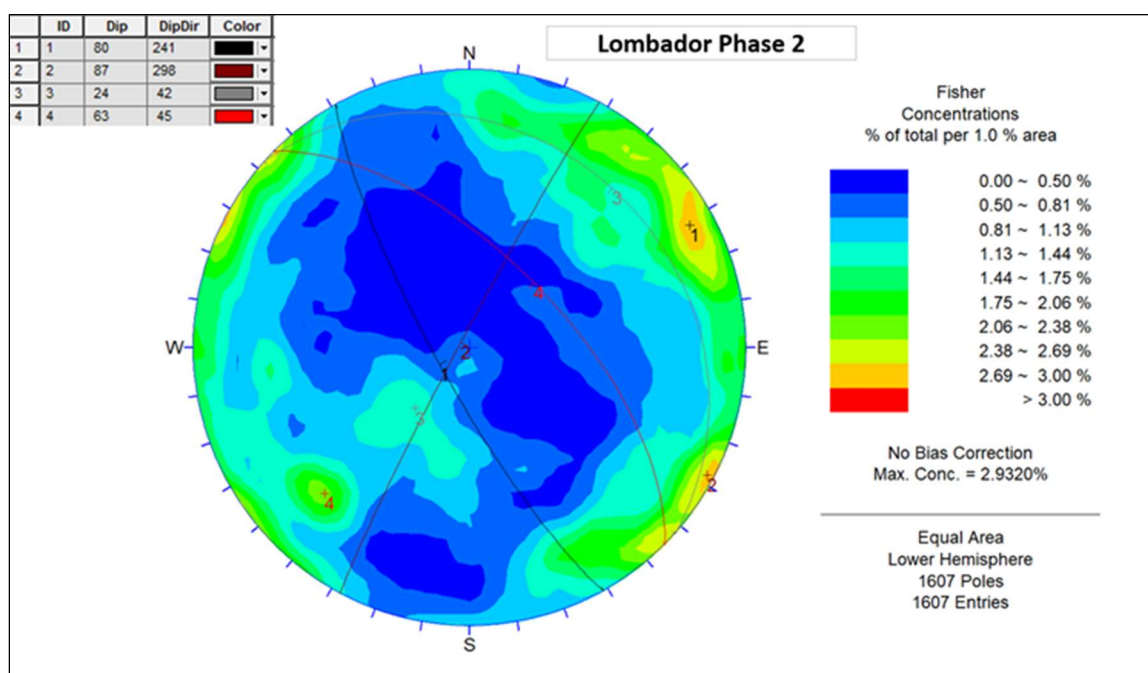

Figure 16.13 Lombador Phase 2 Joint Sets

The massive sulphides of Lombador are divided into three orebodies, Lombador South, East and North. These orebodies are very similar, differing principally in thickness and grades. Typical characteristics of the different ore zones are as follows:

- Lombador South (LP1 and above) includes massive copper (MC) with an average true thickness of 10-15m, and massive zinc (MZ) with a maximum true thickness of 23m, plus some copper

stockwork ores (FC) in the footwall, with an average true thickness of 10-20m. The hangingwall rocks are greywackes and shales (GX) in the southern area, and black shales (XN) to the north-west. The footwall rocks are typically acidic volcanics (V) from the south-western margin to the deposit centre, and from here to the extreme north-east shales and quartzites (PQ).

- Lombador East (LP2) has increased massive zinc (MZ) components with a true thickness of up to 50m and copper stockwork (FC) with an average true thickness of 17m. The hangingwall rocks are mainly black shales, while the footwall rocks are mainly shales and quartzites (PQ).
- Lombador North (LP1 and LP2) also includes in the south-west, massive copper (MC) with an average true thickness of 5m, but towards the north-east the massive copper increases up to 30m thickness. The massive zinc (MZ) is up to 50m thickness, and some copper stockworks (FC) in the footwall average 15-20m thickness. The hangingwall rocks are mainly black shales intercalated with volcanics. The footwall rocks are volcanics towards Lombador South, changing to largely mixed shales and quartzites northwards and with depth.

#### 16.4.2.2 *Stope Stability Analysis*

The copper stopes and the major segment zinc stopes in LP2 have been laid out with the same dimensions and utilising the same mining methods as those currently successfully being used for mining the LP1 orebody. The minor segment zinc stopes have substantially smaller dimensions than the major segment stopes and were therefore not analysed. The stope dimensions analysed by SRK (2015) were:

- MZ orebody: OBF – stope width 15m, stope height 25m and stope length up to 82m. The stope long axis above 160m level is orientated along an azimuth of 30° and below 160m level along an azimuth of 50°; and
- FC orebody: BF – stope width 10m, stope height 25m and stope length up to 28m. The stope long axis is orientated along an azimuth of 50° above and below the 160m level.

The Stability Graph Method was utilised to determine if these stope design parameters are suitable for the predicted geotechnical characteristics and greater mining depth of the LP2 orebody.

The Q' range of values derived from the geotechnical characterisation have been used in conjunction with the stability graph parameters A, B and C to determine the Modified Stability Number (N') for stope backs, end walls and side walls for both massive sulphide stopes and copper stockwork stopes.

The stress parameter "A" was estimated using mining induced stresses produced from the results of LP2 finite element numerical modelling. Input parameters for which, in terms of in-situ stresses and rock mass strength, were provided by a parallel stress analysis study undertaken by Itasca (2013) for the LP2 orebody. Note that the roof contact can be unstable and, as such a pillar to the contact is required. The structural parameters "B" and "C" were derived from an assessment of the interaction of the dominant joint sets with the stope boundaries.

#### 16.4.2.3 *Infrastructure Stability Assessment*

Between 2017 and 2019, Mining One Consultants (2019) completed geotechnical stability analysis for the key excavations relating to the materials handling system. Updated geotechnical domains generated from additional geotechnical drilling and laboratory rock test results form the basis of the analysis. As built geometries were analysed along with extensometer readings to predict and verify the rock mass response to excavation. Mining One provided updated ground support recommendations for areas that required modified support systems.

Design changes were made to relocate the LP2 decline. following a review on the long-term mining sequences impact on stress changes to the decline. A revised stability assessment undertaken in 2022 by Mining One Consultants (2022) demonstrated a considerable improvement in the stability over the previous design iteration. High seismicity in the walls of the updated decline design is primarily localised around faulting and ground support can be selectively applied to manage the ground conditions in fault zones.

Similarly, revised vent raise designs also underwent stability analysis for the updated mine design. Raises in close proximity to faults indicated increased levels of volumetric strain and Mining One concludes that the damage is present prior to stoping, with the damage propagating as the mine schedule progresses.

At this stage the precise location of structural geometries is of low confidence in Lombador North, due to the lack of drilling. This will be remediated as development is completed and areas are made available for geological drilling. As the position of major structural features are refined and the structural model is updated, it is recommended that the infrastructure designs are reviewed and redesigned where feasible, and ground supports are evaluated or modified for the existing facilities.

#### 16.4.2.4 *Support*

Based on the stability graph cable bolt charts, using the  $N'$  values and stope hydraulic radii along with the conservative 20th percentile  $Q'$  value, the following stope back support was recommended by SRK (2015):

- MZ stopes – 9m long cable bolts installed on 2.5m centres; and
- FC stopes – 6m long cable bolts installed on 2.0m centres.

Based on a ubiquitous joint assessment, it was determined that wedges formed by the interaction of joint sets 1, 3 and 4 provided the greatest potential for the development of unstable joint bounded blocks in the back and shoulders of the OBF stopes.

The theoretical optimum support pattern based on the assessment undertaken by SRK comprises of:

- Nine 6m long twin strand cable bolts installed around the periphery of the top drilling cross cut at 1.5m in-ring spacing with rings spaced 2m apart along the axis of the cross cut;
- Surface support is provided by three 2.4m long Swellex bolts in the roof of the drilling cross cut at 1.25m in-ring spacing with rings spaced 1m apart along the axis of the cross cut; and
- If required side wall support can be provided by installing three twin strand cable bolts installed from the mucking drive of the secondary stopes. These bolts will be of varying lengths, 8m, 10m and 12m, bottom to top respectively.

By ensuring the stability of the shoulders of the stope, the height of the stope sidewalls is reduced to an effective 12m, potentially eliminating the requirement for support in the sidewalls under average ground conditions.

The current implemented LP1 OBF stope roof support includes:

- Three 7.2m long cable bolts in the roof at a 2m ring spacing;
- Two 3.6m long cable bolts in the top drift sidewalls at a 2m ring spacing; and
- Six 2.4m long Swellex bolts in the roof at a 1m ring spacing. The stope sidewalls are currently not supported on the first level of the sequence. For subsequent levels, as the upper level becomes the lower level for the stope in the sequence, the support was previously installed.

With the exception of the length of the cables, the theoretical support pattern required in LP2 is similar to current practice in LP1. It should be noted that LP1 stope shoulders generally do not show signs of instability. Consequently, the stope sidewall height is effectively limited, and no additional sidewall support has been required to date.

The LP1 support design includes cable bolt support for the stope end wall to prevent break back to the weaker contact shear zone. In addition to these cable bolts, a massive sulphide skin pillar, of no less than 8m, between the end of the stope and the contact shear is implemented. In LP2 the low-grade halo on the hangingwall side of the zinc orebody ensures that the massive sulphide skin pillar is generally greater than 10m.

Support recommendations made by SRK form the basis of the support types implemented at the mine. In general, new excavations within the orebody are supported with resin bolts and fibre reinforced shotcrete or resin bolts with fibre reinforced shotcrete and mesh. Wider spans, and areas where additional support is required are supported with cables and Osro straps where necessary. On reef excavations are supported with Swellex bolts and fibre reinforced shotcrete or fibre reinforced shotcrete and mesh depending on the ground conditions. A detailed ground control management plan and supporting Mine Standards documents contain an operationally detailed description of the installation methods and support types required for differing mining methods and ground conditions. A review of the support methodology is currently being undertaken internally, following a third-party review in 2022.

The current ground support is a stiff system suitable for static instability. As the depth of mining increases, a system suited to higher levels of deformation and eventually dynamic loading will be required. Support types are being evaluated for their use and applicability for LP2 as well as other areas of the mine.

## **16.5 Water Resources and Hydrogeology**

### **16.5.1 Water Resources**

#### *16.5.1.1 Water Supply*

The ore processing and ancillary water users are supplied with fresh water from the Santa Clara reservoir, which is engineered to hold a nominal capacity of 240Mm<sup>3</sup> of water with a maximum pumping capacity of 600m<sup>3</sup>/h. The reservoir is located approximately 40km from the mine site and it supplies make-up and raw water. Between 2017 and 2022, average water uptake from the reservoir (excluding provision of water for communities) was 2,129 m<sup>3</sup>/day with generally higher rates recorded in 2022 at 2,300 m<sup>3</sup>/day. It is noted, the recent uptake rates are less than those recorded before 2017 and reflect the increased use of recycled water for industrial purposes. Other sources of water include the mine groundwater inflows and non-contact water (rainfall harvesting) collection systems. SOMINCOR has developed a contingency water supply source (Reservatório da Horta da Reveza, EE3) capable of providing 40-days' worth of mine water demand.

#### *16.5.1.2 Mine Dewatering*

The dewatering network for LP2 (which is connected to LP1) is provided by three key pump stations (PS): 700 Level PS, 550 Level PS and CRAM11 (530 Level). The PSs have separate infrastructure components including underground sumps, tanks, transfer pumps on different levels (not just the level indicated by the name). Two further PS are located at CRAM08 (500 Level) and Albraque 10 (620 Level). These are primarily for emergency and backup pumping.

The chosen pumping setup for Lombador assumes a sump and sump pump system installed in both LP2 North and South, below the 220 Level, with the water pumped in stages from these lower levels of the mine using Flygt pumps up to a new PS on 220 Level.

#### *16.5.1.3 Mine Water Management and Reticulation Systems*

Fresh water is sourced from the Santa Clara reservoir, treated on site in a potable water treatment plant (ETAP) and stored in holding tanks (550m<sup>3</sup>) for domestic use. Some of the treated freshwater is distributed from the mine site to the village of Neves. Domestic wastewater originating from within the site is treated in the effluent water treatment plant (ETARD).

The principal components of the mine water systems are shown in Figure 16.14.

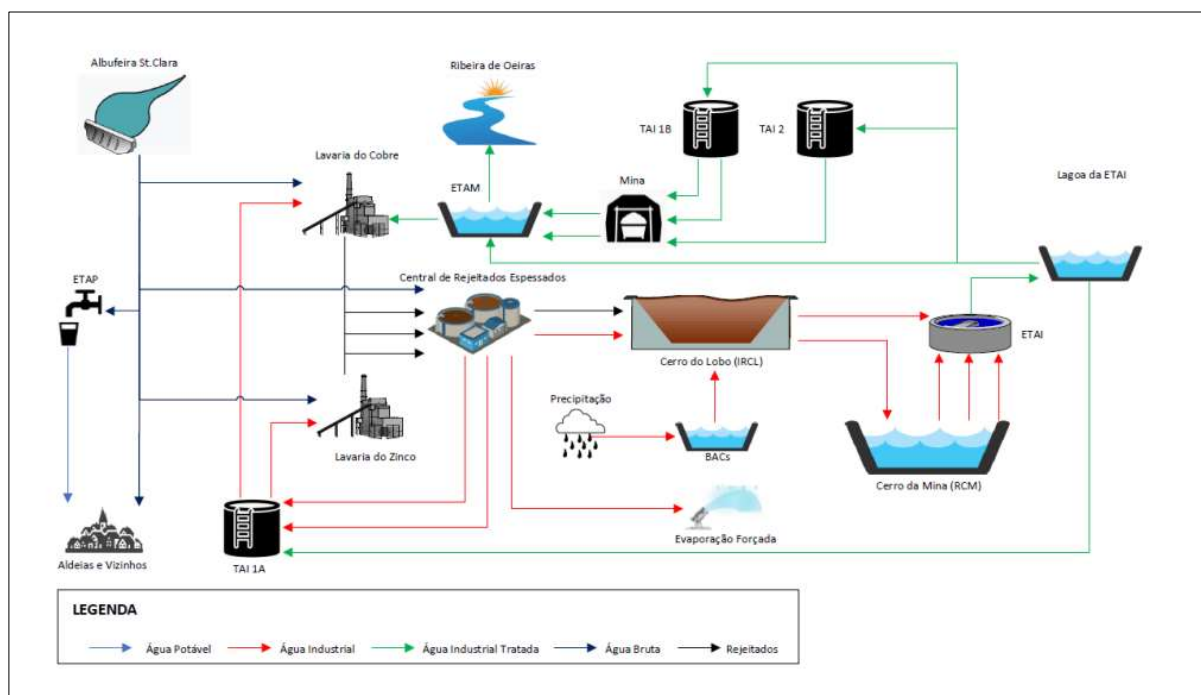

**Figure 16.14: Mine Water Management System**

### 16.5.2 Hydrogeology

Intrusive (drilling) and non-intrusive (geophysics) techniques have been used to define components of the groundwater flow system operating within the mine site, therefore allowing SOMINCOR to formulate a hydrogeological conceptual site model. The site has established a robust groundwater monitoring network targeting both superficial and bedrock groundwater systems for continuous collection of piezometric and water quality records (including those collected in-situ). The qualitative programs identified water quality exceedances (TDS, pH) in boreholes surrounding the zone of oxidised ore (as expected) and also those directly downgradient from the TSF and processing area with concentrations decreasing along the hydraulic gradient of the inferred local drainage basin i.e. River Oeiras. The hydraulic heads surrounding the TSF are elevated and indicate local groundwater mounding. The specific seepage areas from the facilities have been investigated using the geophysical methods to appraise the potential for seepage control.

The monitoring database is sufficient to allow calibration of the numerical groundwater model. The model is calibrated according to hydraulic heads influenced by a pre-existing cone of depression, observed mine dewatering rates (typically oscillating up to 6,000 m<sup>3</sup>/day with maximum 9,000 m<sup>3</sup>/day, between 2015 and 2018). The calibration is also against hydrometric river flows, which appear to provide a good form of representation of groundwater and surface water interactions. The groundwater model was updated to transient mode (most recently in March 2022) and included representation of distributed effective groundwater recharge for the life of mine and after the cessation of mining activities. This allowed insight into the groundwater conditions at mine closure and examination of the time required for full mine groundwater rebound, estimated to be approximately 110 years.



## 16.6 Underground Grade Control Sampling

Underground production faces are sampled by chip sampling in which the 5m x 5m faces are divided equally into sampling areas dependent on the style of mineralisation. Channel chip sampling (Figure 16.15) is carried out for all mineralisation types in which the face is divided into a 3 x 3 grid of vertically aligned channel samples each of 1m in length. Each face is sampled every second or third advance, which equals a sampling interval of 6-9m. Access to the highest samples is attained using a truck mounted access lift with safety cradle. Samples comprise of fragments, chips and mineral dust, and are extracted using a geologist hammer. The obtained sample is deposited into a heavy-duty sample bag and labelled with the sample number. Samples are then returned to the surface and dispatched to the Neves-Corvo Mine Laboratory.

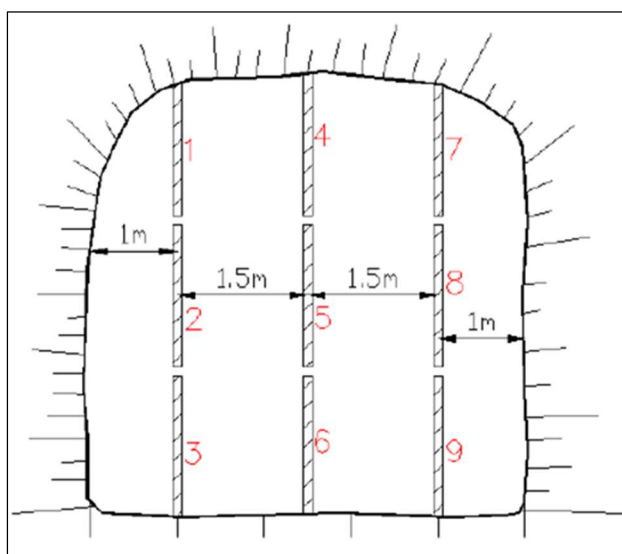

Figure 16.15: Face Sampling Schematic

The face samples are located during collection by measuring from the closest survey point. Each sample is assigned 3D coordinates and imported into the geological database.

## 16.7 Mobile Mining Equipment Fleet

The mobile equipment fleet at Neves-Corvo has increased since the implementation of the LP2 expansion; with updated fleet requirements determined through an in-house model, which determines annualised productivity rates for each of the primary equipment types, from first principles. The resulting fleet requirements are presented in Table 16.4.

Equipment	Availability (%)	2023	2024	2025	2026	2027	2028	2029	2030	2031	2032
Development Jumbos	82	12	13	12	11	13	11	9	7	7	5
Longhole Jumbos	75	4	4	4	4	4	4	5	4	4	2
Development LHDs	78	7	7	7	7	7	6	6	4	4	3
Benching LHDs	78	6	6	6	6	5	6	7	6	6	3
Support Jumbos	78	13	14	13	12	14	11	10	8	7	5
ADTs	80	16	17	15	15	16	16	15	14	14	8

## 16.8 Projects

### 16.8.1 ZEP Status

The ZEP is now complete and is operational, albeit operating below the nameplate capacity due to operational challenges. A summary of these issues and the projects in place to bring the ZEP to nameplate capacity is detailed below:

- The main limitation has been providing a consistent supply of ore to the crusher;
- Underground conveying production is currently limited to 400t/h due to lower-than-expected crusher performance;
- 260 Level crusher hopper: analysis has demonstrated that the current configuration of the hopper base opening results in blockages. In addition, the associated vibrating feeder capacity should be increased. Based on this:
  - An interim solution has been to decrease the grizzly spacing to prevent large blocks passing to the crusher;
  - For 2023, a more optimised solution is planned by SOMINCOR and includes a re-design of the hopper and crusher inlet, to allow a higher throughput;
  - For the vibrating feeder, the main body has been installed with stainless steel liners, to prevent magnetization; and
  - Ongoing plans are to select, purchase and install new feeder pulleys, to increase feeder vibration and to reposition (by angle increase) or replace (by a conveyor belt / apron feeder) the vibrating feeder to increase throughput.
- LP2 transfer tower blockages: four transfer towers are utilised within the conveyor system which brings material from the 260 Level crusher to the 700 Level. The current configuration of the transfer towers can result in blockages of the conveyed material which requires manual unblocking. To resolve this SOMINCOR intends to undertake the following optimisation studies:
  - Test the system at varying throughput rates to identify the conditions which result in blockages and assess the limitations of current design;
  - Installation of air bags on each transfer tower to prevent rock bed size increase.

- Conveyor belt rips: The current electromagnets installed in the crusher and conveyor system are not effective to remove tramp metals in the ore flow. This has been compounded by poor performance of the belt rip detection system resulted in significant conveyor belt rips events and subsequent downtime. The following operational improvements are proposed by SOMINCOR:
  - Belt rip mitigation systems upgrades including improved belt rip detection system and impact beds to install in the main belt feeding areas;
  - Replacement of single cord belt type with a cross mesh belt;
  - Repositioning of cleaning magnets on crushers to improve recovery of steel material parts from the ore; and
  - Studies to replace the existing cleaning magnets with higher power models are being reviewed.

### **16.8.2 Shaft Upgrades**

As part of the ZEP, an expansion of the shaft capacity to 5.6Mtpa was planned. Works are now largely complete, with the shaft currently operating up to 5.4Mtpa. Additional measures required to achieve the ZEP nameplate capacity of 5.6Mtpa are described below (“Scope 1”).

Additionally, SOMINCOR has considered an extended upgrade to the capacity of the shaft to 6Mtpa (“Scope 2”), and improvements to the winder system (“Scope 3”). These works broadly comprise the following, with Scope 2 required to be completed by 2024 to achieve the life of mine plan:

- Scope 1 (5.6Mtpa – Outstanding from the ZEP)
  - Optimize load cells readings
  - Detailed design of new skip feed chute
  - Detailed design of flask 3 support system solution
- Scope 2 (6Mtpa Study and SoW – New Project)
  - Review existing studies
  - Re-design existing safety platform
  - Data analysis of shaft availability and utilization
  - Review rope safety factor
  - New design of head sheaves liners
  - Review hoist motor capacity and performance
  - Control philosophy optimization
- Scope 3 (Double Drum Winder – New Project)
  - Review existing studies
  - Review existing FEA and prepare new FEA
  - Fatigue/utilization study
  - Recommendations

RSV Consulting were used for the evaluation of the shaft expansion alternatives. RSV spent time on-site and measured the power draw of the shaft motor over a five-day period and concluded that the

required capacities can be achieved. To achieve this potential capacity, several changes were recommended and have been implemented or under evaluation.

## 16.9 Backfill Plants

The current backfill systems at Neves-Corvo are paste fill (PF) and whenever possible uncemented rockfill. A hydraulic sand fill plant also supplements backfilling capacity since the commencement of LP2 operations. The current PF plant and associated reticulation has an installed capacity of 85,000m<sup>3</sup>/month.

The paste network comprises 150-200mm (6"-8") diameter, Schedule 80 (A106) pipes throughout. The main network comprises more than 30km of pipes. The water and paste fill networks share a common system of small diameter (1m) raises for routing pipelines inter levels. The paste can be delivery by gravity or pumped.

A breakdown of the fill types per mining method utilised in Neves-Corvo is shown in Table 16.5.

Fill Type	Mining Method	Drilling Pattern	Exposure Length	Exposure Type/Height	Cement (%)	Target Strength (kPa)
PASTE CEM II/A-L 42.5 R (Loulé)	Drift & Fill	-	-	5	3.5	120
	Sill Pillar	-	-	Side: 8	3.5	440
		-	-	Roof: 5	6.5	1000
	Mini-Bench & Fill	Parallel	-	10-15	4	350
		Fan	< 35		4	
	Bench & Fill	Parallel	-	20-25	4.5	440
			< 35		4.5	
		Fan	> 35		5.5	
	Optimized Bench & Fill	Fan	< 35	20-25	4.5	440
		Fan	> 35		5.5	650
	Uphole & Fill	Fan	< 35	10	4.5	440
> 35			>10	5.5	650	
Bench with height >25m	Fan	-	>25m	6.5	1000	
Secondary benches	-	-	-	2.5	-	
HYDRAULIC CEM II B-L 32.5 N (Loulé)	Drift & Fill	-	-	5	3	120
					1	-
	Sill Pillar	-	-	Side: 8	6	250
				Roof: 5	10	1000

The hydraulic fill plant uses sand from SOMINCOR's sand quarry, a small amount of cycloned tailings and cement. It can be used only for the drift stopes due to its very low strength compared to paste fill.

The underground network comprises 100mm-150mm (4"-6") diameter pipes. Coated pipes are used in the boreholes. Hydraulic fill requires a lot of water in the process and for that reason it can only be used in the areas inside the mine with an effective drainage system.

### **16.10 Ventilation**

The complexity of underground workings at Neves-Corvo makes for an intricate and extensive ventilation network. Main circuits in Neves; Graça, Zambujal and Corvo; Lower Corvo; LP1; and LP2 intake air via the main intake raises and main access ramps before exhausting via a series of vent connections and shafts to surface.

Surface ventilation shafts are designated with the prefix "CPV". The main ramp from surface, connects to the bottom of the current mining horizon in Corvo and also services the Graça and Neves orebodies. The Santa Barbara Shaft is also used as an intake and airflow is controlled using doors at each shaft connection.

Exhaust from each area is returned/collected through a series of return air drifts (often referred to as collectors) located above the mining areas through a series of regulated raises. Control of airflow in these raises is achieved by partially covering the top of each (with regulators) in the return air drift. From these drifts, the return air is exhausted to surface through exhaust raises equipped with fans on surface.

The current total intake limit for the ventilation circuit is currently 1,800m<sup>3</sup>/s, with the main ventilation in the mine supplemented in development headings and stopes by auxiliary fans and flexible ducting (800-1,000mm) that can be extended when required. The intake of 1,800m<sup>3</sup>/s is adequate to supply the current mine layout, inclusive of LP2, with planned upgrades to the ventilation circuit now comprising management of temperature via the installation of a cooler in the CPV22 intake raise which is due to take place in 2023.

The main infrastructure to supply the required airflow consists of 12 intake and 9 exhaust raises with diameter ranges from 2.5-4.1m and main exhaust fans of 6,815 kW.

In 2020, the mine suffered the total loss of intake shaft CPV24 due to a geotechnical issue which required significant remediation works including some 1,200m<sup>3</sup> of concrete to fill voids to stabilize the opening, before construction of CPV25 as a replacement.

A schematic of the ventilation network is shown in Figure 16.16.

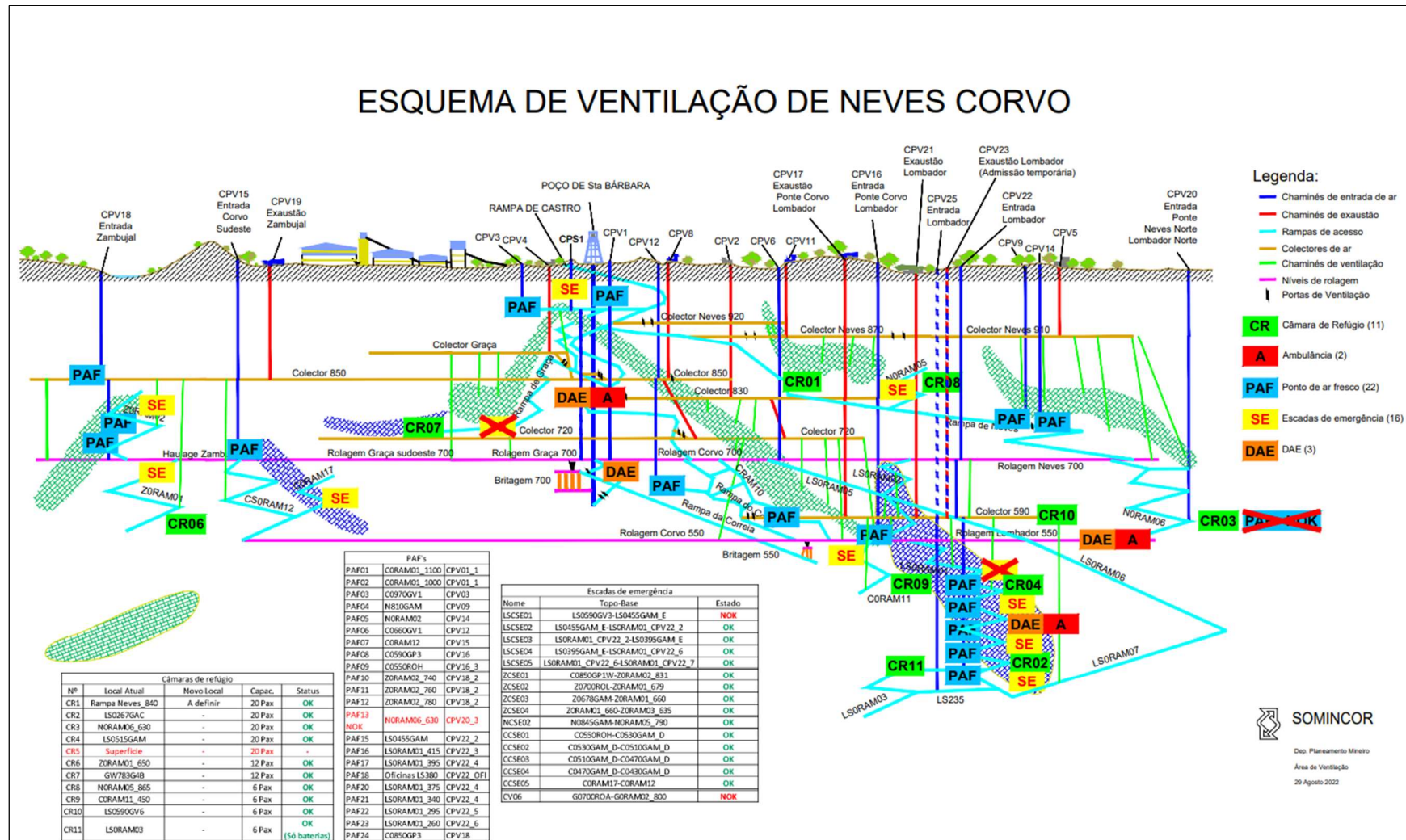

Figure 16.16: Mine Ventilation System

## **16.11 Mine Services**

### **16.11.1 Workshops**

Mobile production equipment workshops are available near the geographical centre of the operation at 810, 590 Levels and at the north-western extremity of the mine at 550 Level. A workshop is also available on 700 Level for mobile haulage equipment. A new main workshop for LP1 is located to the north-west of ramp LSORAM01 on 380m level, with a further workshop facility for LP2 on the 220 Level for servicing LP2 North and South as well as the crusher station.

### **16.11.2 Communications**

#### *16.11.2.1 Radio*

A leaky-feeder radio network provides complementary means of communications to the LTE network.

#### *16.11.2.2 Telephone*

A telephone network is used as the principle means of voice communications to the fixed installations such as the PS; workshop; CRF Plant; Material handling system and as an alternative means of communication to each working level.

The network comprises at least one telephone on each sublevel located at either the mobile transformer station or the level sump, and in the workshops, PS, CRF Plant and Material handling.

#### *16.11.2.3 Fibre Optics*

A fibre optic network runs parallel to the high voltage power network to each of the electrical rooms, crusher stations, materials handling transfer stations, workshop, CRF Plant, PS, as well as to each mobile transformer station on the production levels.

#### *16.11.2.4 LTE*

A private LTE internet network provides the main means of communication. The LTE network covers all underground areas (for a total of 220km) and all surface facilities. The LTE network was configured to support the communication load required by automation initiatives such as telemetry, remote operations and asset tracking systems, with network capacity determined by core capacity, 1Gb upload/download capacity and latency below 50ms. In addition, a total of 1,000 smartphones, connected to the LTE network are used as the main means of voice and text communication in the production and development areas.

### ***16.11.3 Emergency Egress and Rescue***

The main escapeway from the mine in the event of emergency is via the main ramp, shaft and CPS01 service raise. An emergency egress system is provided by installation of the Safescape 1.0m diameter raises developed in parallel to extension and expansion of ramp development, ventilation raises and stoping locations. This system of interconnecting raises at each level will provide an alternative egress system to the ramp. This progressive development minimises the distance between the active mining faces and the emergency egress ways. Underground refuge chambers are located throughout the underground environment and signposted accordingly. The mine utilises a combination of 20-person and 12-person Mine Arc refuge chambers.



## **17 RECOVERY METHODS**

### **17.1 Copper Ore Processing**

#### **17.1.1 Introduction**

The installed capacity of the Copper Plant is 2.8Mtpa. The operation starts at the coarse ore stockpiles, through pre-screening, crushing, grinding, flotation, filtration to concentrate storage and despatch and includes utilities and tailings management.

There are several copper ore types, namely:

- MC (Massive Copper);
- MCZ (Massive Copper-Zinc ore);
- FC (Copper Stockwork); and
- MH (Massive Copper ore with elevated levels of penalty elements; As, Sb and Hg).

The ore types have significantly different processing characteristics and are treated as a blend in the processing plant. The FC stockwork ores are physically harder and coarser grained with generally low levels of impurities. The MC, MH and MCZ ore types are very fine grained, with a liberation size of below 40µm. The MH and MCZ ore types also contain elevated levels of penalty elements.

#### **17.1.2 Copper Plant Description**

The flowsheet for the Copper Plant is shown in Figure 17.1.

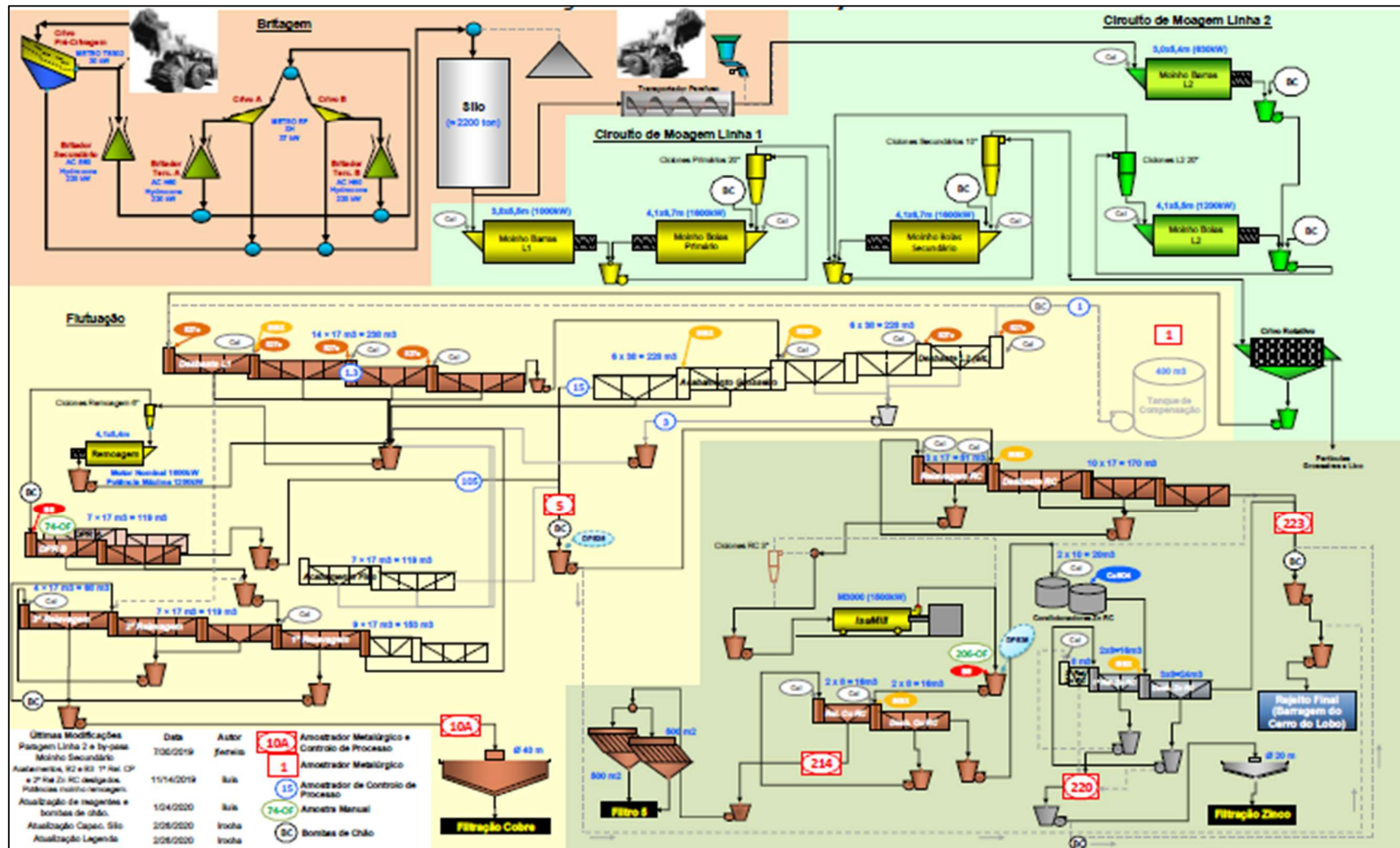

Figure 17.1: Copper Plant Flowsheet

There are two grinding lines. The mills shown in yellow represent nominally the main Line 1 production, but with the secondary Line 1 mill used as a common grinding stage for both lines. The Line 2 mills are shown in green. The main copper flotation circuit is shown on the left of the flowsheet and the recleaning circuit (RC circuit), which recovers copper and zinc from the rougher tailings, is shown on the right. Idled available flotation banks appear in the same colour as the background, or pale yellow.

#### *17.1.2.1 Pre-Screening and Crushing*

Crushed coarse ore from the mine is delivered to dedicated surface stockpiles by conveyor and moving stacker. The ore is reclaimed from the stockpiles by a CAT 988 front end loader into two variable plate feeders, feeding either the pre-screening section and/or the crushers.

The pre-screen, installed upstream of the crusher circuit, is designed to remove the fines fraction (<19mm) existing in the run-of-mine ore. This increases the efficiency of the crushing circuit, especially when the ore has a high moisture content. The circuit consists of a Metso TS502 double deck screen, with a nominal capacity of 800tph.

The undersize discharges directly on to the conveyor belt which feeds the fine ore silo. Fine ore can be stored in the silo to feed both grinding lines, or stockpiled via a chute beside the silo from where it can be reclaimed by loader to feed the second grinding line.

Screen oversize is reclaimed by the front-end loader and fed into the crushing circuit either alone, or mixed with run of mine ore, this is then conveyed to a 60" 'Superior' secondary crusher. All ore passes through the crusher to two 20' x 8' Allis Chalmers Screens.

Screen undersize at <19mm passes via a conveyor to the fine ore silo. Screen oversize passes to two 60" 'Hydrocone' crushers and the crushed product is conveyed back to the screens.

Crushing plant throughput averages 350tph and is operated primarily at night to take advantage of cheaper electricity tariffs and to maximise available maintenance time whilst ensuring sufficient feed stock ahead of the grinding section. The silo has a capacity of 2,500t allowing 10 hours of rod mill feed.

#### *17.1.2.2 Grinding and Re grind*

The primary grinding circuit (Line 1) consists of a rod mill (Allis 3.8 x 5.5m with 1,000kW) in open circuit and a primary ball mill (Allis 4.1 x 6.7m rubber lined with 1,600kW) in closed circuit with hydrocyclones, Sala 20".

The second grinding line (Line 2) is fed by either a screw feeder, which extracts a fraction of the ore stream coming from the silo, at the point where this conveyor is discharging onto the Line 1 feed conveyor, or via front-end loader from the fine ore stockpile adjacent to the silo. The Line 2 circuit

consists of a rod mill (3.0m x 5.6m, with 650kW) in open circuit and a primary ball mill (Allis 4.1 x 5.5m rubber lined with 1,200kW) in closed circuit with Sala 20" hydrocyclones.

Both primary ball mills cyclone overflows report to a common secondary ball mill (Allis 4.1 x 6.7m rubber lined with 1,600kW) in closed circuit with Sala 10" cyclones. Secondary cyclone overflow, at 80% passing 50  $\mu\text{m}$  passes to the flotation circuit, via a rotating trash screen.

Planned milling rate is 260tph (Line 1), and 80tph in the second line. The copper regrind mill (Allis 4.1m x 5.5m rubber lined with 1,200kW) works in closed circuit fed by the underflow of 15 to 25 Sala 6" cyclones that can achieve a d80 of 18-25 $\mu\text{m}$ .

#### 17.1.2.3 *Copper Flotation*

From the primary grinding circuit the slurry passes to the rougher flotation circuit consisting of 14 cells of 17m<sup>3</sup>. Alternatively, the rougher section can be operated using 12 cells of 38m<sup>3</sup>, all Dorr Oliver.

Lime is used for pH control and D527e and sodium isobutyl xanthate (SIBX) are used as copper collectors.

Concentrate from the rougher cells is cycloned and the cyclone underflow gravitates to a 4.1 x 5.4m regrind ball mill fitted with a 1,600kW motor. The reground concentrate passes to the DPR (rougher regrind) cells consisting of 7 x 17m<sup>3</sup> cells. After the addition of sodium metabisulphite to depress sphalerite and pyrite the DPR concentrate is cleaned three times in banks of 9, 7 and 4 cells each of 17m<sup>3</sup>. The DPR tails is either fed to a fine scavenger stage or go to the RC circuit. If the fine scavenger is operated, its concentrate is recirculated to the regrind circuit and its tails go to the RC circuit instead.

The final third cleaner concentrate contains 23-24% Cu and goes to filtration. The tailings of the first cleaner stage go to the regrind circuit. The combined rougher and fine-scavenger tailings feed the RC circuit.

With the Cu feed grade profile being fed to the plant (See Table 17.2) showing a decreasing trend, relative to the original design criteria calling for >5%Cu feed, efforts have been expended in the cleaning circuit to either bypass or shorten some flotation banks as a mean of resizing the cleaning stages to the current requirements, by matching more efficiently available flotation cell volumes to the reduced flowrates seen in this section of the plant. Besides reducing power demand and maintenance requirements, this prevents passivation of the minerals' surfaces and reduces the circuit's inertia to operational changes, stemming from extended retention time.

#### 17.1.2.4 *Tailings Retreatment (RC) Circuit*

The RC circuit was developed to recover copper and zinc values from the Copper Plant tailings. The circuit consists of a bulk rougher/cleaner stage of 10 + 3 17m<sup>3</sup> flotation cells. The concentrate feeds an M3000 IsaMill to regrind the concentrates to < 12 $\mu\text{m}$ . Reground product is then conditioned with

MBS to depress zinc and floated in 8m<sup>3</sup> cells to produce a copper concentrate. This concentrate represents typically a further 3% in overall copper recovery. Copper sulphate is then added to the RC cleaner tails, to activate the sphalerite, and a zinc concentrate is produced in a circuit with two-stage cleaning.

The plant also includes a boiler to elevate pulp temperature to 65°C to aid zinc depression, although this is not currently used.

#### *17.1.2.5 Filtration*

The final copper concentrate is pumped to a 40m diameter thickener where it is thickened to 65-68% solids before passing to the filter plant storage tank. From the tank the slurry is pumped on demand to the five Sala VPA 1530-40 Pressure Filters with a capacity of 25dtph each. Normal operation uses four filters, with one on stand-by for maintenance.

The copper concentrate from the RC circuit is dewatered separately, through a Lamella thickener and then pressure filtration. It is then stored separately in the loadout area, for blending purpose, or to be sold under a separate contract.

The Copper Plant zinc concentrate is pumped to the Zinc Plant thickener and mixed with the zinc concentrates from the Zinc Plant for dewatering.

#### *17.1.2.6 Concentrate Handling*

Filtered Cu concentrate can either be loaded directly into containers via the conveyor load-out system or stockpiled in a storage shed.

### **17.1.3 Sampling and On-Stream Analysis**

Automatic samplers are used to produce daily composites of the mill feed, plant tailings and final copper concentrate. The sample collection and preparation are undertaken by dedicated samplers. The plant is equipped with three Thermo AnStat probes which are located on the plant feed, concentrate and tailings streams, and can determine Cu, As, Zn Sb, Sn and Pb. Up to 12 intermediate process streams are analysed using a Thermo MSA.

### **17.1.4 Utilities**

Reagents for the Copper (and Zinc) Plants are mixed in the Reagent Mixing Station available in each plant and pumped as required.

Tailings are pumped to the paste backfill plant where they are mixed with the tailings from the Zinc Plant. The mixed tailings are cycloned and the underflow is thickened and used for underground backfill.

The overflow, or total tailings when the paste fill plant is shutdown, is pumped 3km to the Cerro do Lobo TSF thickening plant that contains three deep cone thickeners. Tailings after being thickened are sent to final storage at the TSF. Process water from the thickeners' overflow is sent to the Industrial Water Tank (TAI1A), located in the industrial area, from where it is pumped to the Copper and Zinc Plants. This water is partially recycled within the Zinc and Copper Plants and also used to clean the tailing lines. The excess water is pumped to the TSF. In certain periods, water is fully recycled within the plants to meet demand.

The Copper and Zinc Plants are also supplied with industrial water treated at the Industrial Water Treatment Plant (ETAI) and is mainly used for sealing pumps.

#### **17.1.5 Plant Consumables**

The Copper Plant consumables are summarised in Table 17.1.

<b>Table 17.1: Copper Plant Consumables (2021)</b>		
<b>Item</b>	<b>Consumption</b>	<b>Units</b>
Total Steel Media	1,721	kg/t
Ceramic Media (RC Circuit)	0.013	kg/t
Lime (Process Plant)	1,592	kg/t
Dithiophosphate	0.088	kg/t
Xanthate	0.012	kg/t
Copper Sulphate (RC Circuit)	0.027	kg/t
Sodium Metabisulphite (RC Circuit)	0.221	kg/t
Flocculant	0.002	kg/t
Electricity	37.2	kWh/t

The consumption figures are typical for the treatment of a moderately hard, massive pyrite, copper ore.

#### **17.1.6 Plant Performance**

The Copper Plant production since 2000 is summarised in Table 17.2.

**Table 17.2: Copper Plant Production**

Year	Tonnes Treated (kt)	Head Grade (% Cu)	Cu Recovery (%)	Concentrate Tonnage (kt)	Concentrate Grade (% Cu)
2000	1,342	5.34	86.04	319	23.89
2001	1,672	4.93	85.34	344	24.08
2002	1,739	5.08	86.97	319	24.17
2003	1,679	5.35	85.72	330	23.53
2004	1,882	5.74	88.39	401	23.88
2005	2,041	4.96	88.13	366	24.45
2006	1,947	4.56	88.40	319	24.66
2007	2,181	4.78	86.48	393	22.92
2008	2,338	4.29	85.80	366	24.29
2009	2,304	3.93	85.56	349	24.80
2010	2,256	3.43	86.37	304	24.16
2011	2,685	2.74	86.62	304	24.38
2012	2,325	2.64	87.97	245	23.93
2013	2,483	2.60	84.83	239	23.63
2014	2,486	2.53	80.21	217	23.69
2015	2,542	2.72	80.62	232	24.07
2016	2,386	2.55	76.56	199	23.35
2017	2,122	2.09	75.85	146	23.08
2018	2,692	2.24	75.66	202	22.65
2019	2,679	1.97	78.33	180	23.07
2020	2,427	1.67	79.13	137	23.45
2021	2,564	1.86	79.63	167	22.68
H1 2022	1,296	1.76	77.93	78	22.82

The treatment rate in the Copper Plant reached a peak of 2.7 Mtpa in 2018. In recent years copper recoveries have fallen, which is primarily attributed to the treatment of the more difficult MH ore types at higher proportions in the plant feed blend, lower head grades, as well as a degradation of the process water quality being returned from the paste tailing thickeners.

Copper concentrates grades have remained fairly steady, although with a slight fall in recent years, with the average grade of concentrate produced in 2021 being 22.7% Cu. Contaminant levels in the concentrate, such as As, Sb, Pb, have increased in recent years as a higher proportion of the more complex MH is being processed. The plant head grades have fallen over the last six years from 2.55% Cu to 1.76% Cu.

## 17.2 Zinc Ore Processing

### 17.2.1 Introduction

The ZEP surface construction started in 2018 and used much of the process equipment in the 1.15Mtpa Zinc Plant, as well as incorporating new process equipment, to expand capacity to 2.5Mtpa. The plan of the ZEP Zinc Plant expansion is shown in Figure 17.2.

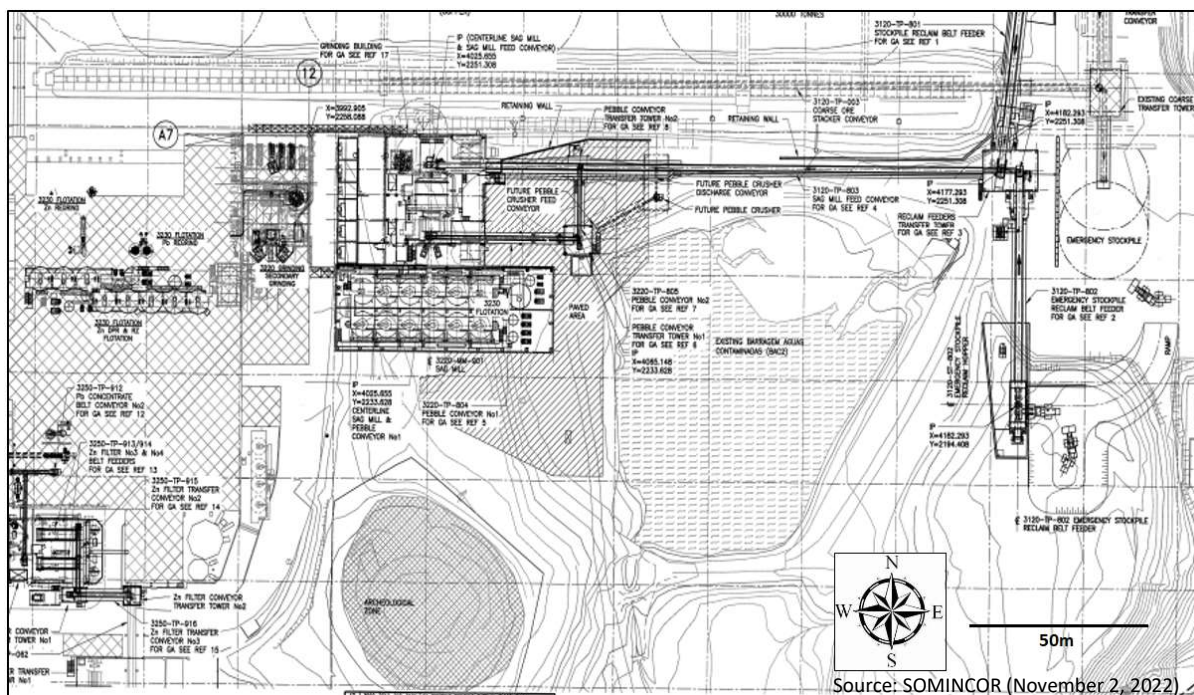

**Figure 17.2: Plan of the ZEP Zinc Plant Expansion**

During construction, delays caused by COVID-19 and capital costs pressures saw numerous reviews undertaken with the aim of reducing ZEP costs and simplifying the production ramp up. During this review period it was decided to not deliver the lead circuit for the production ramp up phase, limiting treatment capacity in the existing cleaners to about 50% of the expanded lead rougher concentrate volume, with the balance reporting to the final tailings. This has resulted in lower than planned recoveries of both lead and zinc. The conversion to “100% Pb” treatment, with the completion of a revised Pb cleaning circuit configuration, will be made in August 2024.

With delays in ore availability from the mine, the planned throughput of the ZEP is scheduled to be 1.7Mt in 2022, 2.2Mt in 2023 and 2.5Mt in 2024.

A flowsheet for the current Zinc Plant, in which only 50% of the lead is treated, is shown in Figure 17.3. The current process flowsheet is described in detail in the following sections.



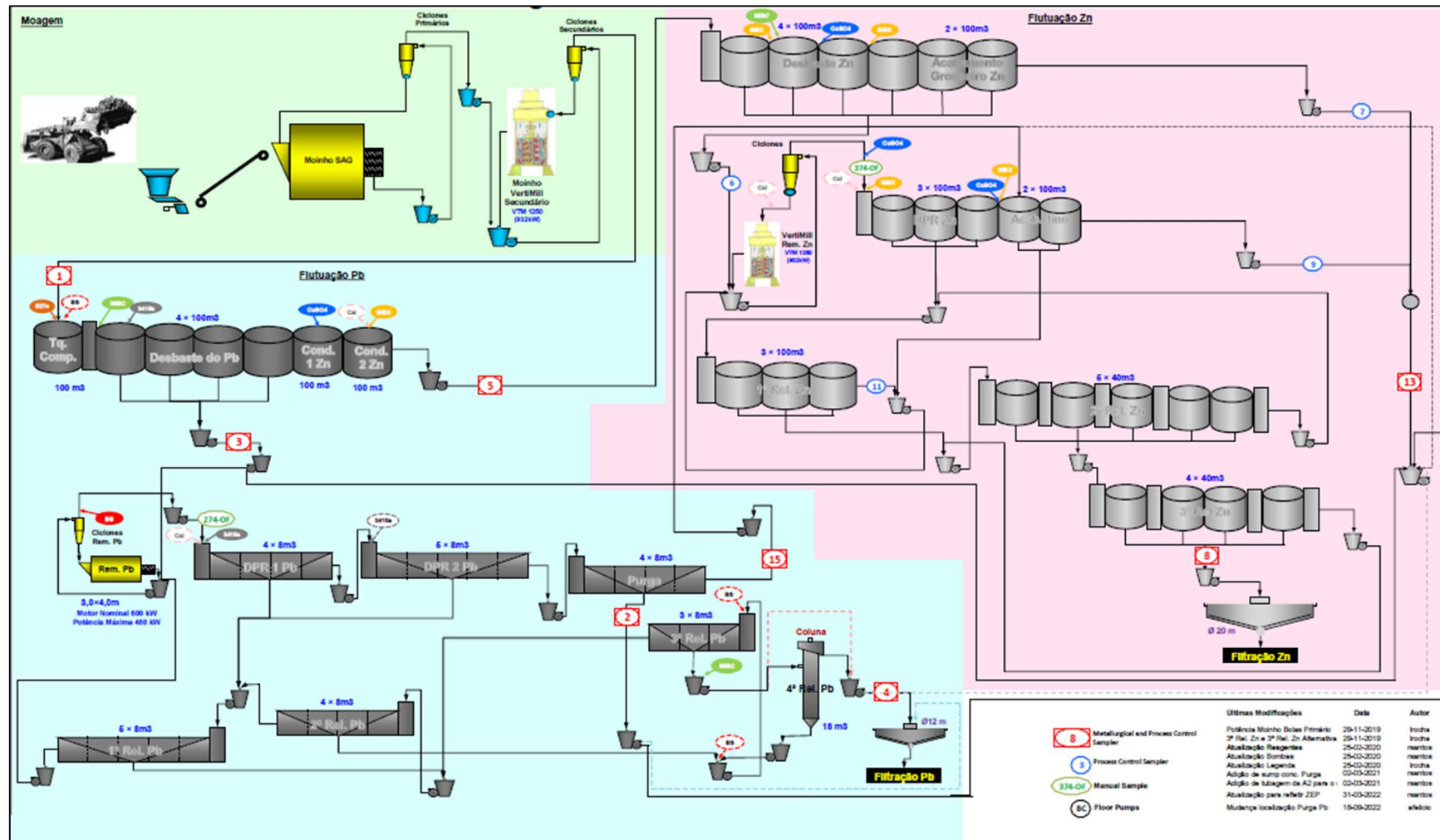

Figure 17.3: Zinc Plant Flowsheet (“50% Pb”)

## **17.2.2 Zinc Plant Process Description (50% Pb)**

### *17.2.2.1 Ore Park, Surface Stockpiles and Coarse Ore Feed*

Zinc ore is now conveyed directly to the Zinc Plant stockpile area and placed using a radial stacker. The coarse ore feed system includes a stockpile reclaim hopper, apron feeder, a transfer conveyor, and the SAG feed conveyor. Ore from the stockpile is fed into the hopper via front-end loader which feeds a transfer conveyor and subsequently the SAG feed conveyor. The SAG feed size distribution is monitored via a Woodgrove PRC Rock Characterization System and controlled by visual selection of coarse or fine areas of the stockpile by the front-end loader operator. The system is not yet automated into a control loop. A weightometer is also installed on the SAG feed conveyor.

A pebble crusher was not included in the design as it was not expected to be required. However, the layout has provided for sufficient space to the north-east of the tower for a pebble crusher to be installed in future, if deemed necessary.

### *17.2.2.2 New Grinding and Flotation Buildings*

The new Grinding and Flotation Buildings are arranged in two sections to accommodate a SAG mill and new lead and zinc rougher flotation cells.

Buildings have been constructed for the following areas:

- Grinding Building: containing the new SAG mill and ancillaries;
- Flotation Building: containing new flotation cells, pumpboxes and pumps;
- New Control Room (within new Grinding Building); and
- New Electrical Substation and MCC Rooms.

The new flotation building houses two parallel rows of 6 x 100m<sup>3</sup> tank cells, with Pb roughers and scavengers in one row, and Zn roughers and scavengers in the other. The cells are located on ground on a sloping concrete floor (falling a total of 5.5m in height), maximising the use of the natural terrain to reduce structural costs. Concentrate and tailings pump boxes and pumps are located at the east end of the building approximately 2m below the last flotation cell in each row.

### *17.2.2.3 Grinding*

The ore is conveyed to a 8.5x 5.4m SAG mill, fitted with Metso:Outotec supplied steel liners with Hi-Lo lifter design and powered by a variable speed 8.5 MW motor. The SAG mill discharge passes via a trommel with 12x55mm apertures, and the oversize is conveyed back to the mill. The SAG mill is loaded with 125mm balls via the mill feed chute.

The trommel undersize is pumped at 70-80% solids (w/w) to a bank of cyclones. The underflow is returned to the mill and the oversize gravitates to the secondary mill cyclone feed sump. The

secondary mill is a VTM-1250 Vertimill fitted with a 932kW motor which is fed by the secondary cyclone underflow. The secondary cyclone overflow passes to flotation. The flotation feed size is currently 80% passing 60 $\mu$ m and it is planned to reduce this to the design figure of 53 $\mu$ m. The grinding circuit is fitted with an automatic particle size analyser although this had not yet been commissioned at the time of the site visit by the authors.

#### 17.2.2.4 *Copper-Lead Bulk Flotation*

Due to the low levels of copper in the zinc ore, the plant is configured to undertake a copper-lead bulk flotation. The circuit is currently configured at “50% Pb Production” mode in which one half of the lead rougher concentrate passes to flotation and the other half is pumped to final tailings.

In this mode Cu-Pb rougher flotation takes place in four 100m<sup>3</sup> cells with half of the rougher concentrate being reground in a ball mill to a size of 80% passing 20 $\mu$ m. The high levels of sulphosalts in the ore result in poor flotation in the first cell which is effectively acting as an aeration stage.

The reground concentrate (50%) is then cleaned four times in conventional cleaner cells. The first stage of cleaning, referred to as the DPR stage, takes place in 9 x 8m<sup>3</sup> cells. The Pb DPR tailings are scavenged in 4 x 8m<sup>3</sup> cells with the concentrate passing to final tailings and the DPR scavenger tailings are pumped to the zinc DPR stage. The DPR concentrate is cleaned three times using conventional cells in 5 x 8m<sup>3</sup>, 4 x 8m<sup>3</sup> and 3 x 8m<sup>3</sup> stages. The final concentrate from the conventional cells passes to a single 18m<sup>3</sup> flotation column. The minimum grade requirement for the bulk concentrate is that 2 x Cu% + Pb% > 31%. The conversion to “100% Pb” treatment will be made in August 2024. It is envisaged that lead regrinding will then be achieved using two M1000 Isamills which will replace the current balls mills and allow it to reach a finer grind size (P80 of 12 $\mu$ m). The “100% Pb” circuit flowsheet is shown in Figure 17.4.

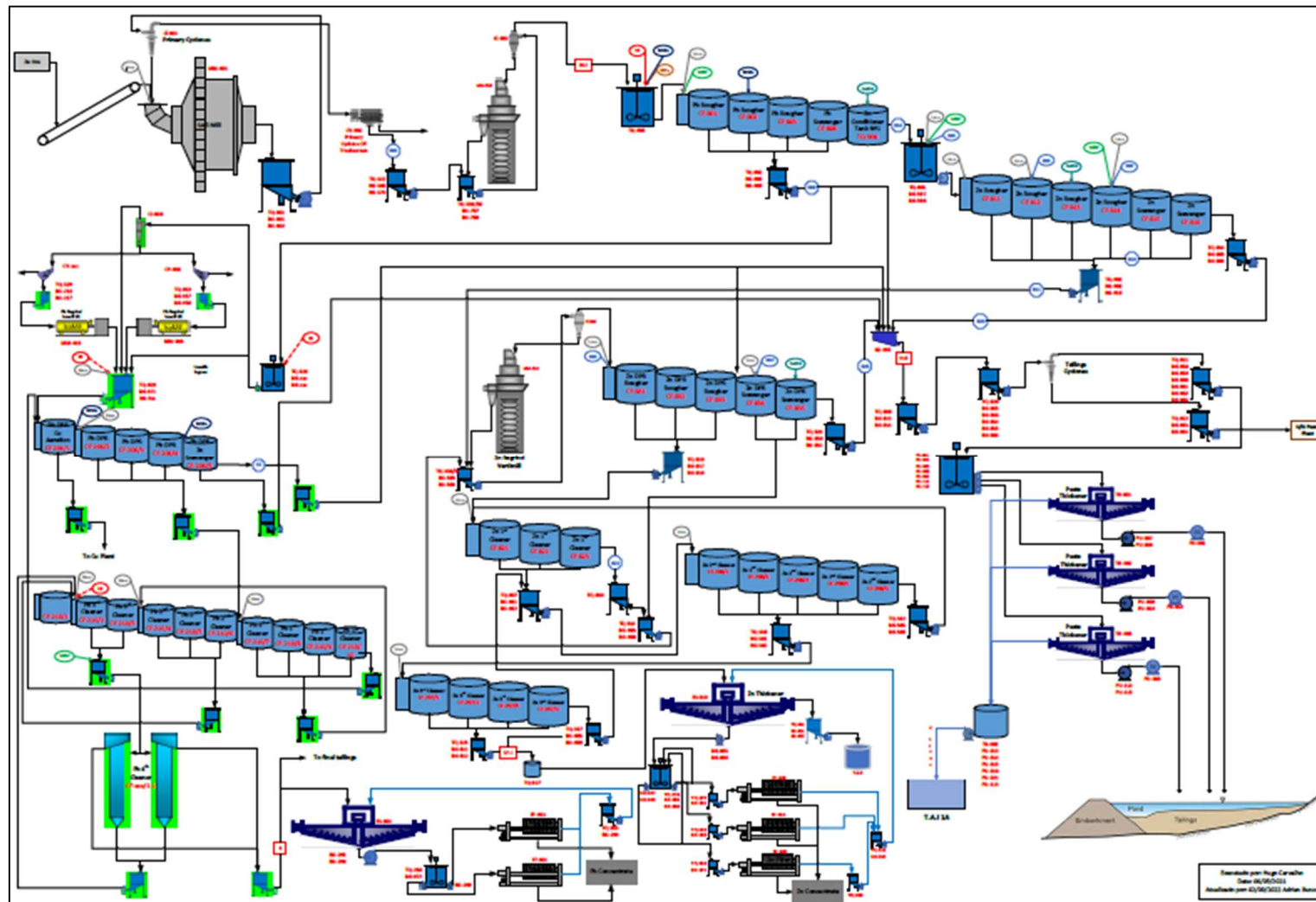

Figure 17.4: Zinc Plant 100% Pb Flowsheet

The lead cleaning circuit will be expanded as follows:

- Pb Aeration/Pb DPR/DPR scavenger: 5x40m<sup>3</sup>
- First Cleaner: 4 x 20m<sup>3</sup>
- Second Cleaner: 3 x 20m<sup>3</sup>
- Third Cleaner: 2 x 20m<sup>3</sup>
- Columns: Potential doubling of current capacity to 2x18m<sup>3</sup>.

#### 17.2.2.5 *Zinc Flotation*

Zinc roughing and scavenging takes place in six 100m<sup>3</sup> tank cells. Due to the poor quality of the process water the high levels of thiosalts force zinc rougher flotation to be undertaken at neutral, or slightly acidic pH. Whereas this does have operational advantages in terms of reduced lime consumption and less scaling from gypsum formation, the optimum metallurgical performance will be achieved though pyrite depression at elevated pH with lime, rather than using poor quality water.

The rougher concentrate is cycloned and the cyclone underflow is ground to 80% passing 20µm in a VTM-1250 Vertimill fitted with a 932kW motor. The reground product is pumped to a bank of 3 x 100m<sup>3</sup> zinc rougher re-cleaner (DPR) flotation cells. The DPR tailings are scavenged in two 100m<sup>3</sup> cells and the scavenger concentrate is returned to the regrind stage. The scavenger tailings are pumped to final tailings.

The DPR re-cleaner concentrate is pumped to the zinc first cleaner (3 x 100m<sup>3</sup> cells). The zinc first cleaner concentrate is pumped to the zinc second cleaner (5 x 40m<sup>3</sup> cells). The zinc first cleaner tails return to the regrinding circuit. The zinc second cleaner concentrate is pumped to the zinc third cleaner (4 x 40m<sup>3</sup> cells). The zinc second cleaner tails return to the zinc first cleaner feed. The zinc third cleaner concentrate is the final zinc concentrate and is pumped to the zinc thickener feed tank. The zinc third cleaner tail returns to the zinc second cleaner. The zinc rougher tailings, together with the DPR scavenger tailings report to the final tailings sump.

#### 17.2.2.6 *RZ Circuit*

The recleaning RZ circuit, in which zinc was recovered from the zinc rougher tailings, was omitted from the final plant design.

#### 17.2.2.7 *Concentrate Thickening and Filtering*

Lead concentrate production will increase as a result of the plant expansion. The Pb concentrate thickener is a 12m diameter high-rate thickener located to the south of the lead concentrate loadout building.

The old lead filter has 12 plates and a second Pb filter with 36 plates (METSO VPA 1030-36) has been added to achieve the required capacity for the plant expansion.

The final filtered copper-lead concentrate is then loaded into 20' shipping containers and hermetically sealed for onward shipment to prevent oxidation of the concentrate in transit.

The final zinc concentrate is thickened in a 20m diameter high-rate thickener. The thickened concentrate is pumped to a concentrate storage tank and the thickened slurry is filtered using three METSO VPA 1530-40 filter presses. The discharge from the filters is conveyed to the covered zinc concentrate storage building.

Water recovered from the concentrate thickening is combined with the water recovered from the filters and recycled to the process.

#### 17.2.2.8 Tailings Disposal and Reclaim Water

Tailings are pumped to the pastefill preparation cycloning station located to the northeast of the Zinc Plant.

#### 17.2.2.9 Plant Consumables

The Zinc Plant consumables are summarised in Table 17.3.

<b>Table 17.3: Zinc Plant Consumables (2021)</b>		
<b>Item</b>	<b>Consumption</b>	<b>Units</b>
Total Steel Media	1.735	kg/t
Ceramic media	0.017	kg/t
Lime (Process Plant)	0.020	kg/t
Dithiophosphate	0.019	kg/t
Xanthate	0.058	kg/t
Aero 3418A	0.031	kg/t
Copper Sulphate	0.75	kg/t
Sodium Bisulphite	0.372	kg/t
Electricity	52.0	kWh/t
Filter Cloths	0.003	Per kt
Diesel	0.165	l/t

The consumption figures are typical for the treatment of a moderately hard, massive pyrite zinc ore.

### 17.3 Mill Labour

A production manager is responsible for both the Copper and Zinc Plant operations. The two concentrators are operated with four shift crews, each comprising two supervisors and nineteen operators. A day crew is used for routine tasks such as reagent mixing, ball loading, general clean-up etc. The plants are scheduled to operate twenty-four hours per day, seven days per week. A summary of the manning levels is given in Table 17.4.

Personnel	Number of Staff
Mill Manager	1
Production	97
Maintenance	78
Process	23
Dams and water	31
Setúbal Port	14
<b>Total</b>	<b>244</b>

### 17.3.1 Plant Performance

The performance of the Zinc Plant since 2012 is summarised in Table 17.5.

Year	Tonnes Treated (000t)	Head Grade (%)		Cu/Pb Bulk concentrate						Zn concentrate			
		Pb	Zn	Conc. Tonnage (t)	Grades (%)		Recovery (%)			Conc. Tonnage (t)	Grade (%) Zn	Recovery (%)	
					Cu	Pb	Cu	Pb	Ag			Zn	Zn
2012	543	0.90	7.26	242	-	35.90	-	1.8	-	58,723	47.6	71.0	-
2013	974	1.17	7.07	4,011	-	37.29	-	13.1	-	107,040	47.7	74.2	-
2014	1,102	1.34	7.96	9,856	-	32.38	-	21.6	-	141,718	45.8	74.0	-
2015	1,014	1.74	8.01	9,589	-	32.09	-	17.4	-	130,379	44.7	71.8	-
2016	1,040	1.77	8.21	13,268	-	31.10	-	22.4	-	147,332	45.8	78.5	-
2017	1,000	2.16	8.74	17,919	4.05	28.82	23.3	23.9	10.6	153,051	45.6	79.9	26.4
2018	1,125	1.89	7.85	24,381	4.51	26.95	21.5	30.9	14.5	156,376	45.6	80.7	28.0
2019	1,137	1.61	7.88	20,595	5.39	26.58	22.0	29.9	12.5	151,504	46.6	78.8	30.0
2020	1,106	1.86	8.09	21,464	5.87	23.80	24.6	24.8	16.4	145,464	46.8	76.2	23.1
2021	1,060	1.80	7.78	22,197	4.45	24.41	21.4	28.4	16.4	133,998	47.2	76.6	24.4
H1 2022	719	1.55	6.91	7,445	5.04	23.07	6.0	15.4	6.7	72,433	46.3	67.4	20.5

Since 2017, the lead concentrate grades have ranged from 4.05-5.87% Cu and 23.07-28.8% Pb. Copper and lead recoveries have been low and, before 2021, averaged 22.6% for Cu and 27.6% for Pb. The copper and lead recoveries have been low in Q1 2022 during the ramp up of the ZEP at 6.0 and 15.4%, respectively due to the limitations of the 50% lead circuit.

Zinc concentrate grades between 2017 and 2021 have ranged from 45.6% to 47.2% Zn and zinc recoveries have ranged from 76.2 to 80.7%. Zinc recovery has averaged 67.4% in Q1 2022 during the ZEP ramp up.

Silver recoveries between 2017 and 2021 have averaged 14.1% to the lead concentrate and 26.4% to the zinc concentrate.

#### **17.4 Analytical Laboratory**

The laboratory operates under the control of the mill manager and services the following areas:

- Geology department;
- Prospection & Exploration department
- Copper and Zinc Plants (Copper and zinc concentrate sampling and assaying);
- Commercial (concentrate sampling and assaying for loading samples and assaying for discharge samples – SOMINCOR);
- Commercial (concentrate shipment samples exchange assaying) – Zinkgruvan and Eagle;
- Environment; and
- TSF (water).

The laboratory is accredited to ISO/IEC 17025 for some 40 analytical methods. The laboratory is very well equipped and includes sample preparation facilities, X-Ray fluorescence (XRF), atomic adsorption spectrophotometry (AAS), Inductively Coupled Plasma (ICP), electro-gravimetric and volumetric methods. The total number of staff employed in the laboratory is 42.

#### **17.5 Adequacy of Supply of Energy, Water and Process Materials**

The authors consider the Neves-Corvo Mine has sufficient supply of energy and water for the current design throughputs for the Copper and Zinc Plants. The sourcing of process consumables is well established with recognised suppliers and logistics.



## 18 PROJECT INFRASTRUCTURE

Infrastructure associated with the Neves-Corvo Mine is detailed below. Numbers assigned to the infrastructure items correspond to the locations shown in Figure 18.1 and Figure 18.2.

- Underground mine (1);
- Mine portal and decline (2);
- Winder house, headframe and hoisting shaft (3);
- Copper Plant (4) and Zinc Plant (5);
- Paste and hydraulic backfill plants (6);
- Ore stockpiles (7);
- Waste dump (8);
- Cerro do Lobo Tailings Storage Facility (9);
- Cerro da Mina Water Storage Facility (lined) (storage of surplus water from the mine) (10);
- Catch ponds (surface run-off) (11);
- Water treatment plant and reverse osmosis plant (12);
- Process plant water storage tanks (13);
- Laboratory (14);
- Truckstop and truck wash (15);
- Workshops and mine store (16);
- Mine office and change house (17);
- Cafeteria (18);
- Medical services facility (19);
- Electrical substation (20);
- Weighbridge (21);
- Security gatehouse (22);
- Administration offices (23);
- Lombador exploration facility (24); and
- Railway and terminals for concentrate shipment (25).



**Figure 18.1: Neves-Corvo Mine Infrastructure**



Figure 18.2: Neves-Corvo Mine Infrastructure (Inset of Figure 18.1)

Infrastructure associated with the Copper Plant and Zinc Plant can be further classified as shown in Table 18.1.

<b>Table 18.1: Copper Plant and Zinc Plant Associated Infrastructure</b>	
<b>Copper Plant</b>	<b>Zinc Plant</b>
Coarse ore stockpiles (“Ore Park”) and reclaim systems	Coarse Ore Stockpile
Crushing and screening	Ore reclaim system
Fine ore storage	Grinding and Flotation
Grinding and flotation	Control Rooms
Control rooms	Thickeners
Thickeners	Filtration
Filtration	Concentrate storage
Concentrate storage	Reagent Mixing
Reagent mixing	

Other infrastructure associated with the operation includes the private harbour facility at the port of Setúbal for concentrate shipments, sand extraction facilities at Alcácer do Sal and an office in Lisbon.

### 18.1 Power

The mine is connected to the national grid by a single 150kV, 50MVA rated, overhead power line that is 22.5km in length.

The Main Electrical Substation 150/15 kV is equipped with:

- One 150 /15 kV 40MVA Power Transformers with a plan for new transformer installation in the near future ;
- Two 150/15 kV 36 MVA Power Transformer;
- Five 15/0.4 kV 63kVA auxiliary transformers with a plan for a new Auxiliary Transformer installation in the near future;
- 15kV Switchgear with 51 cubicles and five bus bars;
- 3x 750 kVA emergency power generators.

Main power distribution network is through medium voltage 15kV level and locally and with lower distribution density of 6kV level. Supply in other medium voltage levels for specific equipment’s is also available. Low voltage 400V level electricity distribution infrastructure is implemented in process areas, workshops, offices, etc.

Surface and underground power network infrastructure is equipped with many types of specialized equipment. The distribution electrical power system consists of such specialized equipment as switchgear, power transformers, power generators, power-factor-correcting capacitors, circuit breakers, high-voltage fuses, protection relays, power-metering systems.

Surface main distribution system is connected to the main electrical substation and consists of:

- 19x 15/0.4 kV Electrical Substations,
- 4x 15/6/0.4 kV Electrical Substations,
- 17x 15/0.4 kV Transformer Stations from 50 kVA to 1,000 kVA,
- 53x Power Transformers from 50 kVA to 12,500 kVA,
- 6kV Electrical Rooms,
- 13x 400V Electrical Rooms,
- 6x 400V Power Generators from 80 kVA to 2,000 kVA,
- Hundreds of kilometers of medium and low voltage cables.

Four independent 15kV feeds connects the underground distribution system to the main electrical substation consisting of:

- 9x 15/0.4 kV Electrical Substations
- 1x 15/6/0.4 kV Electrical Substations
- 62x 15/0.4 kV Transformer Stations from 630 kVA to 1,000 kVA
- Power Transformers from 630 kVA to 3,000 kVA
- 6kV Electrical Room
- 400V Electrical Rooms
- Hundreds of kilometers of medium and low voltage cables.

In 2021, the Neves-Corvo Mine consumed approximately 272 GWh of electrical energy.

## 18.2 Water

The operation has an efficient water management system which maximises recycling of water and transfer between the mining and mineral processing operations and TSF. Where necessary, fresh water is supplied to the mine via a 400mm diameter pipeline from the Santa Clara reservoir, approximately 40km west of the mine. Supply capacity is 600m<sup>3</sup>/hr whilst storage facilities close to the mine hold 30 days' requirements. The current total freshwater requirement for the mine and plant is approximately 100m<sup>3</sup>/hr, in 2022 around 92% of the water used by the industrial process was recycled water.

Process water is mostly obtained directly from the recirculated overflow of the three paste thickeners preparing the tailings for deposition in the Cerro do Lobo TSF. Excess overflow water and runoff of pore and rainwater from the Cerro do Lobo TSF is stored in the Cerro da Mina concrete-lined pond. In 2017, a water treatment plant was constructed by SOMINCOR to improve the quality of the process water with a capacity to treat up to 800m<sup>3</sup>/h of water extracted from the Cerro da Mina. However, levels of thiosalts in the water seen since the commissioning of the expanded Zinc Plant currently restrict the throughput to 500m<sup>3</sup>/h. SOMINCOR proposes to increase the water treatment plant throughput by the addition of one reactor, upgrading of the reagent systems and improved aeration to enable 1,200m<sup>3</sup>/h to be treated. The cost of these modifications is awaiting approval by LMC.

The Cerro da Mina water storage facility, with a capacity of 1.4Mm<sup>3</sup>, was built to cope with the reduction of water storage capacity in the TSF, when the operations switched from sub-aqueous disposal of slurry tailings to subaerial deposition of thickened tailings.

Water can be discharged to the environment if its quality meets standards stipulated in the discharge license. Otherwise, prior to discharging, water is treated through a reverse osmosis (RO) plant with a feed capacity of 100m<sup>3</sup>/h obtained from the ETAI-treated water.

### **18.3 Tailings Storage Facility (TSF)**

Tailings from the mine are stored into a 190ha TSF (Cerro do Lobo) bounded to the north by a rockfill embankment across a natural river valley. The facility was originally developed for sub-aqueous tailings deposition, with a total of 17Mm<sup>3</sup> being deposited using this method. In 2010, the facility was converted to a thickened tailings deposition facility with a thickened tailings plant to increase the storage capacity. The design included disposal of tailings with run-of-mine waste rock, which is potentially acid generating (PAG).

There are three 18m diameter deep cone thickeners located at the TSF with a combined capacity of 375 tph. The design underflow densities range from 62-66% w/w and the particle size (d<sub>50</sub>) ranges from 6-11µm.

In 2021, a total of 1.44kg/t of lime was added to the process water at the TSF for pH control.

Waste rock is used for peripheral berms and covers construction, where the berms demark the deposition areas and levels. The final cover, with a capillary break, followed by clean rock and topsoil will be placed on the top of waste rock cover. The capacity of the facility using this method was 33.3Mm<sup>3</sup>.

In 2022, the footprint of the TSF started to be extended to the south by 18.5Ha to accommodate the ZEP. The TSF storage capacity is being expanded from 33.3 Mm<sup>3</sup> to 50 Mm<sup>3</sup> for extractive waste storage (tailings and waste rock). The expansion will involve a 18.5 Ha footprint extension to the south area and a vertical expansion from 5 to 13 Tiers. The expansion will involve raising the level from 266.3m in Tier 5 to 283.5m in Tier 13.

The TSF's current design has fill approvals to accommodate the current approved LOM. The key design aspects of the expanded facility are shown in Figure 18.3.

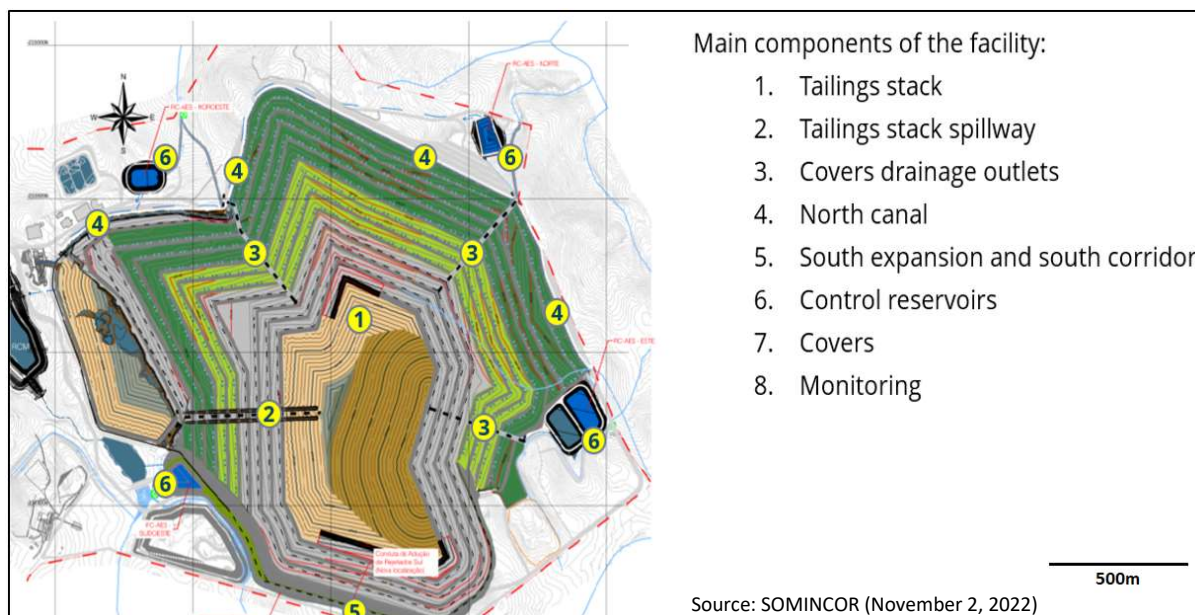

**Figure 18.3: Cerro do Lobo TSF Key Design Aspects**

The thickened tailings are retained by perimeter berms (waste rock) 40 m apart and raised by 2 m, with an overall mean slope of 5%. The berms have a downstream slope of 1V:4H and an upstream slope of 1V:2.5H.

The tailings deposition sequence enables a free superficial drainage inside the stack from East to West, towards the stack spillway which conveys the water to Cell 15 and then to the Cerro da Mina.

The spillway was designed for a 10,000 year storm period. There will be minimum 15m freeboard from the tailings to the top of the berms and a minimum 2.0 m freeboard from the MWL in the channel.

#### 18.4 Infrastructure for Transportation of Concentrates

Storage capacity at the mine site is approximately 15,000 wmt for copper concentrates and 11,000 wmt for zinc concentrates both in covered warehouses.

Copper and zinc concentrates are loaded into 20' containers that are weighed on a static scale. The containers are loaded with a front-end loader or directly from the filters, transported to the on-site train terminal, and craned on to rail wagons. Sampling for determination of concentrate quality is done manually as the front-end loader loads the containers or before the filter drop.

These concentrates are transported 180km by rail from the mine site to the port of Setúbal on the Atlantic coast. The Setúbal warehouse and rail head is owned by SOMINCOR, while the private port is licensed by the Setubal Port Authorities as a private concession to SOMINCOR and another mining company, Almina (pier). SOMINCOR operates the whole installation and has shipped concentrates from the same facility at Setúbal since operations commenced in 1988.

At the port rail terminal there is a system of conveyer belts which connect to the warehouse and to a shiploader at the dock. The Setúbal installation has two warehouses, however only the main warehouse is being used for Neves-Corvo concentrates.

The warehouse has a total gross capacity of 35,000 tons divided into two sections. The copper concentrate is stored in the first section which has a capacity of 22,000 tons. The zinc concentrate is stored in the second section which has a capacity of 13,000 tons. The copper and zinc piles are separated by a wall which reduces some of the net capacity. There is a third section which is treated as a contingency storage space and has a storage capacity of 4,000 tons.

The warehouse contains a linear stacker that feeds all 3 storage sections. The linear stacker feeds the copper and zinc stockpiles directly, whereas to feed the contingency storage area, the stacker dumps on to a smaller conveyor that takes the concentrate to the contingency storage area.

The warehouse also contains a reclaimer machine to load the stockpiles into a vessel. The reclaim can service the zinc and copper storage sections in the warehouse. The reclaimer dumps the stockpiles onto a conveyor that carries the concentrate to the ship loader on the pier.

The contingency storage section cannot be served by the reclaimer. The loading of this pile into a vessel is done using a front end loader, repositioning the material in the zinc section and then reclaimed. Concentrate could be fed into a hopper which would convey concentrates out to the pier directly from the contingency area. However, it does not have a belt feeder and the feed directly by front end loader causes conveyor trip. The inability for reclaiming directly from the contingency area, plus the inevitable double-handling to the zinc section (which can only occur when this is free), make this warehouse only suitable as a backup.

The second warehouse can also be used for concentrates. However, there are currently no conveyors that can move concentrate from trains into this warehouse. The concentrate is brought to the facility through trucks and stacked in the bays using loaders. Due to the space needed for the loader movement, each bay has between 5,000 tons to 7,000 tons of storage. A hopper is present in one of the storage bays and reduces the capacity of the storage bay to 2,500 tons. This warehouse is currently rented to a third party (between 5,000-10,000 tons space) and the contract expires in 2026.

At the main warehouse, concentrates are loaded on to a conveyer belt inside the warehouse, passing over a belt scale and an automatic sampling system, before reaching the vessel docked at a pier. The average loading capacity is 550 wmt/hour, but during the operation, peaks of 1000 wmt/hour can be reached. The vessels operating from this terminal are restricted to the following dimensions; draft 9m, LOA 185m and beam 24m.

Sampling is controlled by the Neves-Corvo Laboratory, which is accredited to ISO 17025 and, the Setubal site specifically, is accredited for moisture determination (ISO 10251:2006) and TML determination (ISO 12742:2007). Sampling is performed by an automatic sampler fulfilling ISO 12743 and compliant with ISO 10251 moisture determination.



Dry mass is calculated from correction of wet mass by the moisture of each 500 wmt sub-lot calculated according to ISO 10251 – Copper, Lead, Zinc and Nickel sulphide concentrates - Determination of Mass Loss of Bulk Material.

The terminal is fully ISPS compliant and the loading operation has an ISO 9001:2008 certification.

SOMINCOR maintains several Contracts of Affreightment with different ship-owners depending on the product and destination. The size of vessels varies between 3,000 wmt and 15,000 wmt, with 7,500 wmt being the most used vessel size.

Official weighing and sampling are normally done at the discharge port under supervision by an internationally recognized inspection company.

The lead concentrates are loaded into 20' standard ISO lined containers at the Neves-Corvo Mine and sent by truck to intermodal terminals at Sines, Setubal or Lisbon and from there to the final destination.

## 19 MARKET STUDIES AND CONTRACTS

Both copper and zinc concentrates, are sold under long term contracts directly to European smelters.

The commercial terms under the contracts are negotiated on an annual basis based on the prevailing market conditions.

With full production of zinc concentrates from ZEP, such strategy will not change. LMC has already allocated the majority of the increase in zinc concentrate production to existing customers. Furthermore, interest in the increased zinc concentrate production has also been expressed by other smelters.

Lead concentrate of commercial quality has been produced at the Neves-Corvo Mine since 2012. Contracts have been negotiated on an annual basis for 100% of the annual production.

The additional quantity of lead concentrates coming from ZEP is very small and it is not expected that any difficulties will arise in placing these lead concentrates in Europe or in Asia. The intention would be to sell the lead concentrates to multiple parties under long term contracts.

All silver contained in the concentrates from Area A belongs to Wheaton Precious Metals Corp. under a silver streaming agreement signed with Silverstone Resources (since acquired by Wheaton Precious Metals Corp.) in 2007 and is invoiced separately when the silver content reaches payable levels.

Credit risks are managed under a strict credit management program which monitors the clients' payment performance as well as restricting credit exposure.

The concentrates from the Neves-Corvo Mine have been sold under long term contracts to major European smelters for many years. The authors have reviewed the contracts and consider the terms are typical for the industry.

## 20 ENVIRONMENTAL STUDIES, PERMITTING AND SOCIAL OR COMMUNITY IMPACT

The environmental and social aspects of the Neves-Corvo operation are summarised in the following section and was based on information provided by SOMINCOR, publicly available data and information collected during the site visit and included the following documents:

- Environmental impact declaration (DIA);
- Environmental conformity declaration (DCAPE);
- Water abstraction license;
- Annual Sustainability reports for 2019-2021;
- Annual Environmental Report (RAA) 2021;
- Discharges and emissions monitoring results for 2019 and 2021;
- Energy Consumption Optimisation Plan (2015-2022);
- GHG Inventory Report, Get2C, 2019;
- Report on Evaporators Noise Impact Assessment, AcustiControl, December, 2021;
- List of introduced BATs in the area of extractive industry waste management;
- Information on Environmental Incidents for 2019, 2021, and 2022;
- Mine Closure Plan, 2022;
- Environmental Monitoring Report, 2021;
- Authorisation to Cut Holm Oaks;
- Authorisation for Compensatory Replantation;
- Communications Plan, 2020;
- Grievance Management Plan, 2020;
- Stakeholder Engagement Plan, 2020;
- Donations and community support report in 2021;
- Summary of Social License to Operate (SLO) Survey Results, 2021;
- SOMINCOR Action Plan 2019 (Rev B), 2019;
- Emergency Activation Protocol, 2021;
- Crisis and Emergency Management, 2019;
- Total injuries report, 2022; and
- Health and Safety Plan, 2021.
- Crisis and Emergency Management, 2019;
- Total injuries report, 2022; and
- Health and Safety Plan, 2021.

### 20.1 Project Status, Activities, Effects, Releases and Controls

#### 20.1.1 Current Operations

The operation is comprised of an underground mine, mineral processing plants including the Copper Plant (capacity of 2.8Mtpa) producing copper concentrates and the Zinc Plant producing zinc and lead concentrates, a TSF (Cerro do Lobo), and associated infrastructure. Construction of the ZEP was completed in Q1 2022 and included an expansion of the mine into the LP2 area of Lombador and an

expansion of the Zinc Plant to 2.5Mtpa, along with upgrading / expansion of associated project infrastructure.

### **20.1.2 Licences and Permits**

According to the Portuguese Legislation (issue from the EU legislation), large and complex projects are presented to the Portuguese Environmental Agency (APA) in the project proposal stage, with the corresponding Environmental Impact Assessment (EIA). After analyzing the project proposal and the corresponding EIA, APA issues the Environmental Impact Decision (DIA), which can be unfavorable (preventing the project from being carried out) or conditionally favorable, where it defines the requirements that must be considered in the execution project phase. After the preparation of the execution project, the Environmental Compliance Report of the Execution Project (RECAPE) is produced which, after evaluation by the APA, leads to the issuance of the corresponding Decision of Environmental Compliance of the Execution Project (DECAPE).

In the case of the ZEP project, in 2017 a conditionally favorable DIA was obtained, and the execution project was divided into 2 sub-projects (Surface facilities + underground and TSF expansion) that had 2 RECAPE (RECAPE 1 and RECAPE 2) that resulted in 2 DECAPE (DECAPE 1 and DECAPE 2), all favorable.

In February 2022, SOMINCOR obtained DGEG approval of the updated Mine Plan for expansion of the Cerro do Lobo TSF and is currently working on the renewal of the Environmental License with support from Quadrante Consultancy. In April 2022, SOMINCOR obtained DGEG approval of the Industrial Permit after ZEP conclusion.

The Unified Environmental Permit (TUA) was updated in 2021 after the issuance of DECAPE 2 and will be updated again prior to the operation of the TSF expansion.

Regarding auxiliary licenses essential for the normal functioning of SOMINCOR, in 2021, SOMINCOR successfully renewed its abstraction licence for the supply of water from the Santa Clara reservoir. The license is valid until 2025. A new discharge of treated industrial wastewater licence to the Oeiras River was also issued in 2021, valid until 2026.

### **20.1.3 Air Quality**

Emission sources from the Neves-Corvo mining complex include ore handling activities, traffic of heavy vehicles and machinery, operation of two diesel boilers and a ventilation system. Ore handling activities generate fugitive dust. Emissions of combustion engines include nitrogen dioxide, sulfur dioxide, carbon monoxide and volatile organic compounds. Diesel boilers emit particulates, CO (carbon monoxide), SO<sub>2</sub> (sulphur dioxide), NO<sub>2</sub> (nitrogen dioxide), H<sub>2</sub>S (sulfide hydrogen) and various metals (Pb, Cr, Cu, As, Ni, Cd and Hg). Emissions associated with the ventilation system include nitrogen dioxide, sulfur dioxide, metalloids, and particulates.

SOMINCOR employs dust suppression and associated management measures that are widely used across the mining sector. These include watering of roads, enforcing speed limits (30km/h), covered

conveyor belts, and sweeping of paths. SOMINCOR has systems for continuous particulate monitoring in three nearby villages as well as at the industrial area. Diesel boiler emissions are also regularly monitored.

#### **20.1.4 Water Management and Effluents**

The mine received 774 ML of water from the third-party Santa Clara reservoir supply for operational use in 2021. SOMINCOR recognizes that there is risk associated with sustained long-term availability of this resource for operational supply, given the reservoir's location in a water-stressed catchment area and the increasing use of the water from this reservoir for agriculture purposes. SOMINCOR has prioritized actions to reduce reliance on the reservoir supply, upgrading water management infrastructure and procedures to improve water reuse and recycling, thus recirculating in excess of 93% of the total water received in 2021. Upgraded instrumentation will track water use more closely across the operation, with the aim of identifying opportunities to replace the use of freshwater in operational areas. Towards the end of 2021, the water treatment circuit was upgraded with an RO unit, enabling replacement of freshwater with treated water in the mine's paste plant. In addition, alternatives to the Santa Clara reservoir continue to be evaluated both for potable water and operational water. Despite the progress described, meaningful reduction of freshwater use could not be achieved in 2021, due to constraints on internal water recycling resulting from other water treatment challenges, including increased rainfall. SOMINCOR does not discharge to a water-stressed area.

Additional water-related risks being managed by SOMINCOR include acid-generating potential of the ore and waste rock stockpile, the proximity of the Oeiras River to the mine site, and the presence of a groundwater system that is part of a significant aquifer connecting to local water supplies and the Oeiras River. To support effective management of these risks, SOMINCOR is progressing the development of its groundwater model and continues to conduct regular monitoring of the river and the local aquifer.

SOMINCOR managed a controlled discharge of operational water to the Oeiras River over a seven-week period from January to March 2021. The discharge was necessary to safely manage water that had accumulated in onsite water stores due to a combination of high precipitation levels and operational factors including a water treatment plant fault. Due to the unplanned nature of the discharge, compliance with permitted sulphate and daily flow rate levels was not always achieved; however, no negative impacts were identified in the Oeiras River as a result of the high natural flow rate in the river at the time of the discharge. High-efficiency evaporators were installed in March and October 2021 to reduce excess volumes of water at the site.

#### **20.1.5 Hydrology**

In terms of surface water, the project area is located in the Oeiras River basin, which is a sub-basin of the Guadiana River. SOMINCOR has permission to discharge to the Oeiras River when there is sufficient flow in river.

If discharge to the Oeiras River is necessary, SOMINCOR continuously monitors the quality of water prior to discharge. Monitoring has revealed:

- Treated industrial effluent discharged into the Oeiras River still contains elevated concentrations of sulphates but very low levels of regulated metals;
- Recirculated water is of sufficient quality; and
- The discharge location along the Oeiras River affected by the discharge displays a localised change in water quality, with near-complete recovery downstream and with no discernible impact in the downstream Guadiana River.

Following resolution of past water quality issues, SOMINCOR is investigating options to reduce fresh water supply requirements and introduce a passive wetlands treatment step, thereby controlling environmental issues throughout the water balance.

To meet water quality discharge thresholds the water management system was redesigned and re-engineered according to the 2016 Environmental Audit report.

The redesign measures included:

- Reduction of the open water areas of the TSF;
- Replacement with thickened paste tailings;
- New water treatment facilities; and
- A major new water impoundment (Cerro da Mina).

These design measures have since been implemented by SOMINCOR.

Portuguese discharge quality standards have been met since the introduction of this system. Previously there were problems with sludge build up in the ETAI process prior to discharge, and evaporative concentration of solutes in the treatment cycle. However, it is understood these issues have been resolved. The ETAI, which is in continuous operation, was designed for a theoretical treatment capacity of 800 m<sup>3</sup>/h, and a thiosalts content of 200 ppm. However, this flow rate was never achieved. Recently, the concentration of thiosalts in the industrial water has increased to 700 ppm. Due to this increase it has been necessary to reduce the feed to 500 m<sup>3</sup>/h, to ensure full removal of the thiosalts in the treated water and stay within the maximum allowable dosage of reagents. Detailed engineering for the expansion of the ETAI to 1,200 m<sup>3</sup>/h is under way.

The updated 2016 EIA reports on the overall water consumption and surface water discharges, and these are expected to increase due to the ZEP. However, they will stay well within the permitted requirements due to improvements in water recycling and water management on site. In line with international best practice, proposed mitigation measures include implementing monitoring of water balance changes as well as training of staff in environmental awareness.

The 2016 EHS Audit reported a potential risk of site-wide soil and groundwater impacts due to only one pond at Neves-Corvo being lined (Cerro da Mina). Other water storage ponds are unlined, some receive contaminated water. In addition, although the walls of the TSF are lined for geotechnical stability reasons, the base is not and gradual dispersal of leachate via the base of the TSF is a feature of the original design. Potential groundwater impacts from these waterbodies are largely captured in the mine dewatering cone or through pumping wells around the mine. This water is not treated but is, rather, pumped to the TSF in a captured loop within the mine site.

In addition to the ETAI, the site employs a reverse osmosis (RO) unit. The RO is owned by a contractor (jointly operated with SOMINCOR) and is only used when required during periods of high rainfall. The unit is only operated when necessary to manage the water balance to be net zero discharge through the use of evaporators. The RO units are available to prepare a blend of water with other treated waters from the Mine Water Treatment Plant (ETAM) and/or the ETAI to meet the legal limits of the license prior to discharging to the environment.

### **20.1.6 Waste Management**

SOMINCOR has no formal industrial waste management plan. All industrial waste generated by the Neves-Corvo operations is managed following applicable EU and Portugal waste regulations. The site outsources licensed waste management contractors, who are obliged to comply with relevant laws and regulations to ensure appropriate waste transport, treatment, and disposal beyond the site boundaries.

SOMINCOR has a formal and legal Extractive Waste Management Plan. Mineral waste that is produced by the operations include waste rock and tailings. This waste is handled in accordance with the National Legislation and with best available techniques developed for the Management of Waste from Extractive Industries, in accordance with EU Directives. Waste storage facilities have closure plans that include plans for their final design. Part of the waste rock generated during mining activities remains underground, approximately 60% in 2021. The surface waste rock stockpiles occupy an area of 9ha and have ARD controls incorporated in the design. It is expected that at the end of the LOM, all waste rock will be used for backfilling of mined out voids, construction of TSF berms and cover in a co-deposition with tailings. Clean cover material will be placed on the top of the waste rock cover.

Currently, SOMINCOR operates one downstream TSF (Cerro do Lobo) consisting of one main dam, seven perimeter dams, and six internal berms. The TSF is being expanded, and additional internal berms will be constructed during the expansion. Once the expansion is complete, the total planned TSF storage capacity (tailings and waste rock) will be 50 Mm<sup>3</sup> and is sufficient to support the current Mineral Reserves. Generated tailings are reused for backfilling of mined out areas. Two types of backfill are used: hydraulic fill (comprised approximately 2% of tailings) and paste fill (comprised 97% of tailings). Following completion of ramp-up of the ZEP, the backfilling operations will consume approximately 46% of the tailings generated by the mine.

### **20.1.7 Energy Consumption and Source**

Neves-Corvo is the third-largest energy consumer of LMC's operations, with its consumption reflecting its production levels. Energy for the mine is mainly sourced from electricity (~80%) and fuel (~20%). Annual total energy consumption and total Scope 1 and Scope 2 greenhouse gas (GHG) emissions across LMC's operations are subject to external assurance annually in accordance with ISO 14064. A site specific inventory has been developed in alignment with the Intergovernmental Panel on Climate Change (IPCC), the World Resources Institute/ World Business Council for Sustainable Development (WRI/WCSD) and the Greenhouse Gas Protocol (GHG Protocol), and this information has been reported annually in LMC's Sustainability Report and CDP Climate Change since 2010.

Total annual energy consumption in 2021 was 1,231,220GJ, including 988,652GJ from electricity, and 242,596GJ from fuel. In 2021, GHG (Scope 1 + Scope 2) emissions intensity of the operation increased due to commissioning of the ZEP and the operation of evaporators to manage excess precipitation. Scope 1 GHG emissions reported in 2021 were 18,700t of CO<sub>2</sub> equivalent, and Scope 2 emissions amounted to 96,066t of CO<sub>2</sub> equivalent.

In 2019, SOMINCOR commissioned Get2C consultancy to undertake an inventory of (GHG) emissions along the value chain, to identify the GHG-intensive activities and develop a tailored emission reduction strategies and plans. The GHG inventory was prepared in accordance with the guidelines of the Intergovernmental Panel on Climate Change (IPCC) and the World Resources Institute/ World Business Council for Sustainable Development (WRI/WCSD), within the scope of the GHG Protocol, and ISO 14064. As the result of the work the sources of Scope 1, Scope 2, and Scope 3 emissions were identified, and the resultant amount of emitted CO<sub>2</sub> equivalent was evaluated at 122.1kt.

SOMINCOR complies with regulatory requirements, completing periodic energy audits and submitting formal plans for energy efficiency to national authorities. An Energy Consumption Optimisation Plan for 2015-2022 identified replacement of certain equipment of the underground facilities, the Copper Plant, and the Zinc Plant with more energy resource effective technologies and installation of power factor compensation units.

Since 2019, SOMINCOR started replacement of vehicles and equipment with more efficient, sustainable technologies to improve environmental and operational performance and improve working conditions. A fully electric forklift was added to the waste management fleet to replace the previous diesel-run model, resulting in a reduction of 12 tonnes of CO<sub>2</sub> emissions per year. SOMINCOR also purchased six new Epiroc MT65 mining trucks that are more eco-efficient vehicles transporting loads of up to 65 tonnes with reduced diesel consumption. In 2020, the mine was awarded the Sustainable Transport Certificate by Medway for their contribution to reducing CO<sub>2</sub> emissions using rail transportation.



### **20.1.8 Noise and Vibration**

In May 2021, SOMINCOR hired ACUSTICONTOL consultancy to assess noise emissions of the evaporators installed at the Cerra do Lobo TSF. Acoustic measurements were taken in the vicinity of the evaporators, and near sensitive noise receptors located in the vicinity of the TSF, including at the SOMINCOR-owned premises Monte Branco and Monte da Eira da Pedra, located around 1,400m to the southwest, and a small village Semblana, located 2,100m to the southwest. The results of the measurements indicated exceedance of regulatory requirements. Suggested noise mitigation measures (rotation of the evaporators, arrangement of acoustic barriers) were found to be insufficient to ensure compliance with the regulatory requirements in Monte Branco and Monte da Eira da Pedra locations. It was estimated that the noise emissions will be within permissible levels in Semblana given the operation of only two evaporators, although the noise audibility may lead to discomfort for the inhabitants. In November 2021, SOMINCOR received a grievance from Semblana residents related to the noise generated by the evaporators. To mitigate the impact, the evaporators operational schedule was revised, and a study of soundproofing solutions was completed. A noise reduction system has also been installed in one of the evaporators.

### **20.1.9 Biodiversity**

SOMINCOR's lands lie adjacent to the Oeiras River, a High Biodiversity Value Area integrated into the Guadiana Valley Natural Park as part of the European Natura 2000 network. The operation partially overlaps Castro Verde Special Protection Area for Birds (PTZPE0046) and a Site of Community Interest (PTCON0036 – Sítio Guadiana), in addition to several nearby nature conservation areas, namely the Vale do Guadiana (PTZPE0047), Piçarras (PTZPE0058) and Caldeirão (PTCON0057), as well as Guadiana Valley Natural Park.

Some of the ZEP area falls within a National Ecological Reserve ("REN", Decree-Law No. 166/2008), including the industrial area of SOMINCOR. More specifically, the location of the CPV23 surface exhaust fan falls within a national conservation area. The proposed construction of infrastructure necessitates the removal of some protected Holm Oak trees. SOMINCOR has obtained permits to remove trees and is obliged to compensate two Holm Oaks for each one removed. A permit to plant new trees has also been obtained.

The Oeiras River is located adjacent to the operation and is an area of high biodiversity value where both the tributary system and the Guadiana Valley Natural Park have protected status as part of the European Natura 2000 network. Conservation of the Oeiras River and downstream catchment habitat is prioritised by SOMINCOR, and it has long-standing partnerships with Portuguese universities, national conservation organizations, and natural park authorities to support river health and assist in the protection of endangered and vulnerable species, including supporting the Castro Verde Special Protected Area to promote the long-term conservation of great bustards and participation in the Portuguese Nocturnal Butterfly Stations Network initiative.

SOMINCOR monitors a localised biodiversity impact in the Oeiras River arising from SOMINCOR's permitted water discharge to the river over the years. To reduce the potential for impacts, the operation discharges only when necessary, and suspends routine discharge when there is no flow in the river. Protection and monitoring of the river is a high priority as it falls within the Guadiana Basin where both the tributary system and the Guadiana Valley Natural Park have protected status. No site discharge-related impacts have been identified in the Guadiana River.

## **20.2 Environmental and Social Impact**

An Environmental Impact Assessment (EIA) for the ZEP expansion was completed by the Portuguese firm PROCESL in 2016. The study covered environmental and social aspects of the ZEP, identifying predicted negative and positive impacts of development.

The EIA concluded that implementation of the ZEP will make a significant contribution to the socio-economic development at the local, regional, and national level. An overall environmental impact of the Project was also assessed as positive given the implementation of appropriate mitigation measures.

## **20.3 Environmental Management**

### ***20.3.1 Environmental Policy and Company Approach***

SOMINCOR does not have a separate environmental and social management system, however it operates in accordance with LMC's Responsible Mining Policy (RMP) and follows the requirements of LMC's Responsible Mining Management System (RMMS). The Responsible Mining Policy (RMP), updated in February 2022, establishes LMC's commitment to sustainable practices and principles that guide LMC and its subsidiaries in ensuring the success of the long-term Sustainability Strategy and business objectives. Comprising 17 principles, the RMP policy addresses the key elements of Responsible Mining that include health and safety, environmental stewardship, social performance, economic contribution, compliance, and governance throughout the mine cycle. The principles of this policy require employees, suppliers, customers, contractors, and business partners to adhere to the principles of this policy when operating on LMC's sites or on LMC's behalf.

The RMMS comprises of 16 requirements which describe mandatory criteria that apply to all LMC operations. These criteria reflect international best practice aligned with the ISO 14001:2015 Environmental Management System Standard, Occupational Health and Safety Assessment Series (ISO45001), and the Global Industry Standard on Tailings Management (GISTM), with sites encouraged to develop the application of these requirements in a site-specific manner.

### ***20.3.2 Environmental Management Staff and Resources***

SOMINCOR has an Environmental Department headed by a dedicated Environmental Manager and involves accredited laboratories and independent environmental consultants for environmental

sampling and third-party audits. SOMINCOR also has its own ISO 17025 accredited laboratory that carries out environmental analysis of water and effluents.

### **20.3.3 Environmental Systems and Work Procedures**

LMC has developed several company-wide environmental management planning procedures, including air quality and GHGs, water management, mine closure planning and biodiversity management (Environmental Programmes), to ensure that all LMC's operations implement effective management of environmental aspects during exploration, mine planning, development, operations, mine closure and aftercare.

### **20.3.4 Environmental Monitoring, Compliance and Reporting**

Environmental monitoring at SOMINCOR is carried out for environmental aspects related to air quality, surface and ground water, noise, aquatic ecology, and heavy metal concentrations in birds' blood and feather in accordance with the EIA, DIA's (DIA 2008 and DIA 2017) as well as DCAPE 2019 and 2021. As per DCAPE requirements SOMINCOR will submit a Surface and Groundwater monitoring programme to APA, planned for submission in the first half of 2023.

The groundwater monitoring network has boreholes distributed upstream and downstream of the TSF, around the industrial area, water ponds and other facilities. Surface water monitoring points are located along the rivers, upstream and downstream of the mine site, and include surface runoff collection ponds. Groundwater quality is monitored for a range of parameters, including piezometric level, pH, temperature, electrical conductivity, dissolved oxygen, potential redox Ca, As<sub>tot</sub>, Cu, nitrates, Na, K, Zn, Fe, Mn, Pb, Cd, Cr, nitrites, chlorides, sulphates, ammonia nitrogen, total suspended solids and hardness. Groundwater monitoring is carried out at monthly, quarterly, and annual frequency. In 2021, several groundwater samples returned results exceeding the permissible level for the majority of monitored parameters, due to a natural background. One exceedance of permissible limits in surface water was attributed to an external influence and not associated with mining activities.

In 2021, air quality was monitored only for PM<sub>10</sub> in Aldeia de Neves and the village of Senhora da Graça de Padrões. The particulates were monitored on a weekly basis using high-volume air samplers. Two cases of permissible level exceedance were reported. At the end of 2019, three new monitoring stations were installed, according to DIA/DCAPE and RECAPE recommendations to monitor metal concentrations associated with the TSF expansion.

In 2021 several ecological indicators of Oeiras River were monitored. Data on macroinvertebrates and algae communities show environmental stress on downstream sites closer to the mine but, further downstream the river shows signs of recovering since flora and fauna are similar to reference sites. In addition, analyses of the fish community does not show environmental problems directly originating from the mine. Furthermore, data indicates that there is no greater bioaccumulation of metals in organic tissues downstream of the mine when compared with upstream. The inverse occurs

occasionally, which can be attributed to variations in water chemistry related to possible old mining operations. Final reports of 2022 biomonitoring campaign of are still pending.

Noise monitoring locations include Sta. Bárbara de Padrões (Reference location), Monte da Várzea da Forca, Sra. da Graça de Padrões, Aldeia do Neves, and Aldeia do Corvo. Based on noise monitoring results, carried out in 2017 and 2018, the DIA recommended additional noise monitoring be carried out once the ZEP expansion was operational. However, following public grievances previously described an unscheduled acoustic study was conducted in 2021.

SOMINCOR monitoring results are also included in an annual Sustainability Report that discloses financial and non-financial performance indicators of LMC, including environmental, social, and corporate governance criteria. The Sustainability Report is published annually on the corporate website.

One Level 3 incident was reported in late 2021 in which a rupture in the tailings pipeline resulted in a release of tailings to land and the adjacent Oeiras riverbed. The riverbed was dry at the time of the release, allowing the tailings to be contained and removed, with downstream impact assessed to be unlikely. Subsequent upgrades ensued to protect the river and included tailings pipeline replacements and improvements to spill containment structures.

#### **20.4 Emergency Preparedness and Response**

LMC implements a corporate Crisis Management Standard and crisis management plans. The crisis management plans are supplemented by site-specific emergency response plans, catering to each operation, that maintain emergency response capabilities, a variety of firefighting and rescue equipment, and specialized PPE that is suited to each working environment and operational jurisdiction.

Emergency preparedness and response for personnel is formalised on the corporate level within LMC's RMMS Requirement 11 entitled 'Crisis & Emergency Response'. The standard aims to ensure that processes are established to protect personnel, to minimise business disruption, and to mitigate negative impact to the community, the environment, and assets in the event of an emergency. In 2022, SOMINCOR activated its crisis management plans in connection with fatalities at Neves-Corvo in March and September.

#### **20.5 Training**

Site-based emergency responders and mine rescue teams receive regular training on equipment and emergency response techniques. Practice exercises, simulated emergency scenarios and external training are regularly provided to ensure that team skills are maintained.

## 20.6 Social and Community Management

Social performance at SOMINCOR is managed and monitored by the Corporate Social Responsibility (CSR) team, which is comprised of the following personnel: the CSR head of department, and two communication specialists: one responsible for corporate social responsibility/community relations and one responsible for internal and external communications.

### 20.6.1 Social Performance

SOMINCOR's social performance is supported by the Strategic Social Implementation Plan (SSIP 2019). Areas of Influence identified in the plan include the communities of Castro Verde, Almodovar, Aljustrel, Mértola and Ourique. The plan seeks to manage eight social risks (Dependency, Zinc Expansion Project, Closure, Reactive Relationships, Biodiversity, Perceptions about the environment, Water Impact/Use and Workforce and Labour) and covers activities such as Stakeholder Engagement, Grievance Management, Communications, Community Investment, Local Content and Strategic Management and Planning. A new Social Strategic Plan will be presented in 2023.

In terms of local employment and procurement, the SSIP reports that there was 98% local employment in 2020 and 100% local employment in 2021. The report shows there has been an improvement in the percentage of female employees, increasing from 10.2% females employed in 2016 to 13.2% in 2021. National procurement dropped from 92.8% in 2020 to 82% in 2021. The reduction in procurement was mainly due to ZEP main suppliers and materials being outside of the country.

SOMINCOR has ongoing community investments in its Area of Influence. These can be divided into two types:

- Strategic investment - based on the social baseline study, is focusing on education and entrepreneurship for adolescents to avoid future dependency on the mine after closure ; and
- Participative investment - focusing on communities most affected by the mine operations.

Total community investment for 2021 was reported at US\$295k excluding strategic social investment for entrepreneurship in schools. Money invested/donated was shared between four categories: 70% was invested in Community and Wellbeing (mostly sport-supporting activities), 16% in Education and Training (e.g. school equipment), 9% in Community Safety and Security (e.g. vehicle purchase for firefighters) and 5% in Arts and Culture (e.g. restoration of an altarpiece).

Additionally, LMC invests money independently of mine investments, through the Lundin Foundation. Planned investment of US\$400k, facilitated by the Lundin Foundation and completed in 2021, included for example local supplier development.

### **20.6.2 Stakeholder Engagement and Communications**

Communication and relationship with stakeholders are outlined by the Stakeholder Engagement Plan (SEP), the Grievance Management Plan (GMP) and the Communications Plan.

The Stakeholder Engagement Plan (SEP) was developed in 2017 and approved in 2020. The SEP was designed to achieve SOMINCOR's 5-year strategic performance plan, gain a deeper understanding of stakeholders and broaden social engagement. The stakeholder list is updated regularly through a dedicated platform called SimplyStakeholders. A perception study was conducted in late 2018 determining preferred engagement activities. Engagement is monitored and the SEP outlines qualitative and quantitative indicators of participation. Reporting includes a monthly stakeholder engagement report submitted to the site and corporate management. Additionally, special community reports cover the progress of implementation of the mitigation measures, findings from the monitoring activities and status of community investment initiatives. Engagement activity and SEP results are updated and tracked on the Simple Stakeholder platform.

The Grievance Management Plan (GMP) complements the SEP and was issued in 2020. The current GMP is designed for both internal and external stakeholders and considers a compensation policy. There are three channels for people to file their potential grievances: email, postal mail and through the ClearviewConnects platform. The GMP includes a monitoring plan which incorporates a monthly report on the grievance trend analysis. According to the CSR Head of Department, the mine registers approximately 4-5 grievances a year, mostly concerning noise, dust and vibration complaints. Currently all grievances are registered as closed.

The Communications Plan was signed in 2020 and is implemented together with the SEP. The Plan encompasses internal and external communications. It includes instructions on presenting project information in a culturally appropriate manner, considering language, customs and education level. Media monitoring is outsourced.

The social perception of the mine is reported to be generally positive. The 2018 Social Perception Study found that 85% of the community approved of the operation and 15% were neutral towards it. This positive trend continued and was reflected in the Social Licence to Operate survey in 2021. The study area included the Area of Influence as mentioned in the SEP and 675 people were interviewed. The mine scored 3.4/5 in the category measuring trust and 3.6/5 in the acceptance of the continued operations of the mine.

## **20.7 Health and Safety**

The mine Safety Department consists of three separate teams: Emergency Response (4 team members), Occupational Safety (7 members) and Industrial Hygiene (2 members). The three teams report to the Safety Head of Department who reports to the Health, Safety and Environment Director.

As of year-end 2022, the Neves-Corvo Mine suffered 26 recordable cases, 16 with SOMINCOR employees and 10 with contractors, including 2 fatalities. In 2022, the total recordable injury frequency (TRIF) was 1.13.

Guidance for the OHS department is included in the following plans:

- Safety Management Plan, signed in July 2022, and includes: a risk matrix, training guidelines and information on chemical handling and explosives. The plan includes the presence of a site clinic with two medics and an ambulance. The clinic conducts alcohol testing and vaccine campaigns;
- Emergency Response Plan, updated in 2022, and includes an emergency activation protocol;
- Crisis and Emergency Management Policy, signed in 2019;
- In 2022 Neves-Corvo participated in 10 sessions with the health & safety leaders across the business to discuss investigations from significant and high-potential incidents. These sessions included the discussion of root causes of the incidents and sharing of lessons learned. All investigations are shared across the business; and
- In conjunction with the corporate Health & Safety Team, Neves-Corvo has been participating in the development of a new injury and fatality prevention program that will advance the next stage of LMC's safety culture evolution and is designed to prevent high potential incidents, eliminate fatalities, and reduce repeat events. This program is called Fatal Risk Management (FRM) and will be the focus of the Health and Safety Team for the next 1-3 years until it is embedded across the business. FRM focuses on the identification of 18 fatal risks found in the mining industry and the implementation of critical controls to mitigate these risks.

The OHS department is involved in supply chain management and has guidelines for contractors. All contractors must present a work plan with the procedures, risk analysis, task-specific sheets, safety data sheets and insurance policies. The documents must be submitted and approved before the contractors are coming to site. Once a contract is awarded, OHS monitoring is implemented only during execution. Post-work evaluation should be part of a comprehensive OHS monitoring system, in which a comparison of the work that was expected at the bidding stage is undertaken against the final outcome, once the work has been completed. That would include a review of whether initial OHS objectives were met and a review against the recorded incidents / results.

According to the statistics in 2022, 32% of the workforce at SOMINCOR is unionised. The communication with unionised workers takes place in two ways: directly with the union to discuss H&S aspects or through the Health and Safety Committee, which has representation from some union members. The H&S Committee is also comprised of elected members. The H&S Committee consists of 6 worker representatives elected, the managing director, 5 managers (EHS, Mine, Process plant, HR, CFO) and the H&S Head of Department. H&S aspects and trends are discussed once per month and the Committee decides how to collaborate with awareness training.

Grievances related to Health and Safety are managed through a platform called FirstPriority that all employees can access. It includes information on near misses and unsafe conditions. Each reported

grievance is followed by a report and an action plan. The OHS Team has the capacity to receive anonymous grievances as well as in-person grievances regarding sensitive issues.

## **20.8 Mine Closure Plan**

An updated Mine Closure Plan was submitted to DGEG in December 2022. Following the recommendations of the Environmental Audit in 2016, a two-stage closure-related socioeconomic impact study was undertaken and identified expectations from key stakeholders such as local government authorities, community-based organisations, and representatives from business groups, to inform the social transition planning process.

Key closure and rehabilitation solutions include:

- Deposition of soils contaminated with hydrocarbons offsite;
- Placement of metal containing soils on the TSF;
- Backfilling of the ventilation shafts followed by plugging with concrete;
- Restoration of mine water level to a baseline level; and
- Landscaping of the area.



## 21 CAPITAL AND OPERATING COSTS

### 21.1 Capital Costs

Total capital costs are estimated at €591.7M over the LOM as summarised in Table 21.1.

Item		Unit	2023	2024	2025	2026	2027	2028	2029	2030	2031	2032
Mining	Lateral Development	€M	39.8	41.8	40.7	40.4	35.7	32.8	4.6	7.2	2.0	3.0
	Vertical Development	€M	5.1	4.5	2.7	4.3	6.7	3.2	0.3	-	-	0.3
	Other Mining	€M	29.6	33.6	24.0	16.6	12.5	-	-	-	-	-
Mill		€M	10.7	26.2	17.2	6.1	2.6	-	-	-	-	-
TSF		€M	30.9	-	-	-	-	-	-	-	-	-
ZEP Project Allowance		€M	12.2	9.6	-	-	-	-	-	-	-	-
Other		€M	1.1	13.1	3.6	0.0	0.0	18.8	14.4	14.1	12.6	7.2
<b>Total Capital Costs</b>		<b>€M</b>	<b>129.3</b>	<b>128.9</b>	<b>88.1</b>	<b>67.4</b>	<b>57.5</b>	<b>54.7</b>	<b>19.3</b>	<b>21.4</b>	<b>14.6</b>	<b>10.5</b>

Capital costs include mine development estimates, derived from the LOM development schedule at a cost of €4,500/m for lateral development and €2,000/m for vertical development, and other sustaining projects planned for the first 5 years of the LOM plan; from 2028 a factor of €3.0/t is used to project other sustaining capital costs in the long term. Closure costs are estimated at €52.0M based on the LOM cash flow model dated November 14, 2022.

### 21.2 Operating Costs

The operating costs are shown in Table 21.2. Total operating cost over the LOM are estimated at €2,762M which equates to €60.6/t of ore milled.

Item	Unit	2023	2024	2025	2026	2027	2028	2029	2030	2031	2032
Mine	€M	188.0	182.1	180.9	180.7	188.6	179.3	156.3	154.5	143.1	98.4
Mill	€M	84.6	68.8	69.4	69.2	69.7	69.4	64.6	63.8	62.1	49.5
Tailings	€M	16.4	14.6	14.9	14.6	15.0	14.7	12.6	12.6	11.6	9.3
Other / G&A	€M	31.4	31.1	31.3	31.5	31.7	31.3	29.9	29.5	29.2	25.1
<b>Total Operating Costs</b>	<b>€M</b>	<b>320.4</b>	<b>296.5</b>	<b>296.5</b>	<b>296.0</b>	<b>305.0</b>	<b>294.7</b>	<b>263.5</b>	<b>260.4</b>	<b>246.1</b>	<b>182.4</b>
Tonnes of Ore Milled*	Mt	4.7	5.1	5.2	5.2	5.3	5.2	4.4	4.3	3.9	2.2
Cost Per Tonne of Ore Milled	€/t	68.8	57.7	56.6	56.9	57.6	56.3	60.1	60.8	62.7	81.5

\*Combined production from Copper and Zinc Plants

A breakdown of the operating costs attributed to the mine and processing plants is shown in Table 21.3.

**Table 21.3: Breakdown of Mine and Process Plant Operating Costs (2023 to 2032)**

Item		Unit	2023	2024	2025	2026	2027	2028	2029	2030	2031	2032
Mine	Stope Mining	€M	101.8	107.2	108.4	108.4	111.4	103.3	86.5	85.5	76.3	44.3
	Materials Handling	€M	32.4	29.6	27.9	28.0	31.7	31.0	27.9	27.6	26.9	20.2
	Technical Services / Indirects	€M	53.8	45.2	44.5	44.3	45.5	45.0	41.9	41.4	39.9	33.9
	<b>Total Mine</b>	<b>€M</b>	<b>188.0</b>	<b>182.1</b>	<b>180.9</b>	<b>180.7</b>	<b>188.6</b>	<b>179.3</b>	<b>156.3</b>	<b>154.5</b>	<b>143.1</b>	<b>98.4</b>
Copper Plant	Labour	€M	6.4	6.4	6.4	6.4	6.4	6.4	6.3	6.3	6.2	6.0
	Electricity	€M	16.3	6.0	6.0	6.0	6.1	6.0	5.6	5.5	5.3	4.7
	Consumables	€M	7.5	7.5	7.7	7.6	7.9	7.7	5.3	5.2	4.0	1.3
	Other	€M	9.3	9.5	9.6	9.6	9.7	9.6	8.4	8.3	7.8	6.1
	<b>Total Copper Plant</b>	<b>€M</b>	<b>39.5</b>	<b>29.5</b>	<b>29.8</b>	<b>29.6</b>	<b>30.1</b>	<b>29.8</b>	<b>25.6</b>	<b>25.3</b>	<b>23.3</b>	<b>18.1</b>
Zinc Plant	Labour	€M	5.8	5.8	5.8	5.8	5.8	5.8	5.7	5.7	5.6	5.4
	Electricity	€M	16.8	6.6	6.6	6.6	6.6	6.6	6.6	6.6	6.6	6.1
	Consumables	€M	14.9	18.7	18.8	18.8	18.8	18.9	18.8	18.4	18.8	13.4
	Other	€M	7.6	8.3	8.3	8.3	8.3	8.3	7.9	7.9	7.7	6.4
	<b>Total Zinc Plant</b>	<b>€M</b>	<b>45.1</b>	<b>39.3</b>	<b>39.6</b>	<b>39.6</b>	<b>39.6</b>	<b>39.6</b>	<b>39.0</b>	<b>38.5</b>	<b>38.8</b>	<b>31.4</b>

## **22 ECONOMIC ANALYSIS**

Companies which are active and current producers of saleable product issuing a NI 43-101 Technical Report may exclude the information required under Item 22 of Form 43-101F1 for Technical Reports on properties currently in production unless the Technical Report includes a material expansion of current production.

The cash flow model for the LOM was reviewed by the authors and showed the Mineral Reserves to be economic based on the assumptions used and metal prices of: US\$1.15/lb for zinc, US\$0.90/lb for lead, US\$3.35/lb for copper and US\$4.40/oz for silver (the silver price used reflects the contract to Wheaton Precious Metals Corp.).

---

## **23 ADJACENT PROPERTIES**

There is no information regarding adjacent properties applicable to the Neves-Corvo Mine for disclosure in this report.

---

## **24 OTHER RELEVANT DATA AND INFORMATION**

There are no other relevant data or information to report in this Technical Report about the Neves-Corvo Mine.

## 25 INTERPRETATION AND CONCLUSIONS

The authors make the following conclusions:

### 25.1 Geology and Mineral Resource Estimates

Since discovery in 1977, the Neves-Corvo Mine has been extensively explored with a total of 811,776m of surface drilling and 892,522m of underground drilling completed up to June 30, 2022. All drilling was conducted by diamond core drilling. Near mine exploration at Neves, Corvo, Graça, Zambujal and Lombador has been successful in identifying extensions of mineralisation and upgrading Mineral Resources, while regional exploration has been successful in identifying the deposits of Semblana and Monte Branco. A total of 84,958m of regional exploration drilling was completed from 2017 to 2021 and identified Lombador North, Zambujal East and Semblana East and North as targets for further exploration.

The drilling, logging, sampling, analysis and QA/QC procedures used are considered suitable for the purposes of Mineral Resource estimation.

Mineral Resource estimates were prepared using drilling, face sampling and geological mapping data to construct three dimensional wireframes of mineralised domains. Grades were estimated into a geological block model representing each mineralised domain. Grade estimation was carried out by ordinary kriging or inverse distance weighting. Estimated grades were validated globally, locally, and visually prior to tabulation of the Mineral Resources. Reconciliation indicates that the Mineral Resource models compare satisfactorily to plant production data.

As of December 31, 2022, and at a cut-off grade of 1.0% Cu, the Measured and Indicated Mineral Resources for the Neves-Corvo copper zones are estimated to be 56,033kt with average grades of 2.2% Cu, 0.8% Zn, 0.3% Pb and 44g/t Ag. Inferred Mineral Resources are estimated to be 14,185kt with average grades of 1.8% Cu, 0.6% Zn, 0.2% Pb and 29g/t Ag.

As of December 31, 2022, and at a cut-off grade of 4.5% Zn, the Measured and Indicated Mineral Resources for the Neves-Corvo zinc zones are estimated to be 65,101kt with average grades of 0.3% Cu, 6.8% Zn, 1.4% Pb and 61g/t Ag. Inferred Mineral Resources are estimated to be 3,897kt with average grades of 0.3% Cu, 5.7% Zn, 1.6% Pb and 64g/t Ag.

As of December 31, 2022, and at a cut-off grade of 1.0% Cu, the Mineral Resources (wholly Inferred) for Semblana are estimated to be 7,807kt with average grades of 2.9% Cu and 25g/t Ag.

### 25.2 Mining and Mineral Reserve Estimates

Underground mining at the Neves-Corvo Mine has been continuous since 1988, with the production plan for 2023 budgeted at 2.7Mt of copper ore with an average grade of 1.8% Cu and 2.2Mt of zinc ore with an average grade of 7.2% Zn. Beginning in 2024, zinc production is projected to increase to

2.5Mtpa. The final year of full production is expected to be 2029. Total hoisted rock (ore and waste) ranges from 5.4Mtpa to 5.8Mtpa.

Mining methods include: Drift & Fill, Bench & Fill, Optimised Bench & Fill, Mini Bench & Fill, Uphole Bench & Fill and Sill Pillar Recovery. The mining methods are well understood and have been developed and upgraded as understanding of the orebodies has increased with time.

An expansion of the shaft capacity to 5.6Mtpa is now largely complete, with the shaft currently operating at between 5.2Mtpa to 5.4Mtpa. Additional measures required to achieve the nameplate capacity of 5.6Mtpa are being implemented. In addition, an extended upgrade to the capacity of the shaft to 6Mtpa is also planned to be completed by 2024 to achieve the LOM plan. Further optimisation of the mining infrastructure at LP2 is also planned for the 260 Level crusher hopper, conveyor transfer towers and conveyors.

As of December 31, 2022, at average NSR cut-off values ranging from €44/t - €60/t, the Proven and Probable Mineral Reserves for the Neves-Corvo copper zones are estimated to be 21,207kt with average grades of 2.1% Cu, 0.6% Zn, 0.2% Pb and 33g/t Ag; and the Proven and Probable Mineral Reserves for the Neves-Corvo zinc zones are estimated to be 22,299kt with average grades of 0.3% Cu, 7.5% Zn, 1.7% Pb and 63g/t Ag.

### **25.3 Mineral Processing**

The mineral processing plants consist of a Copper Plant and a Zinc Plant which produce copper, zinc and lead concentrates using crushing, grinding and flotation. The two plants are well established and the ore types that are treated have been extensively researched and their processing characteristics are well understood. The workforce is experienced and possesses a high degree of operational knowledge.

The Copper Plant has a capacity of 2.8Mtpa of ore through two separate grinding lines with a common flotation circuit. Recoveries have reduced marginally in recent years due to lower copper head grades and higher proportion of MH ore in the plant feed. In 2021, the Copper Plant treated 2,564kt of ore at an average grade of 1.86% Cu and produced 167kt of copper concentrate.

The Zinc Plant was constructed in 2006 with a capacity of 0.5Mtpa and was expanded in 2010 to 1.15Mtpa with a further expansion to 2.5Mtpa in 2018 to 2022, as part of the ZEP. In 2021, the Zinc Plant treated 1,060kt of ore at average grades of 7.78% Zn and 1.80% Pb and produced 134kt of zinc concentrate and 22kt of lead concentrate. Production from the Zinc Plant during 2021 was less than capacity due to ramp up of the ZEP.

The flotation performance of the Zinc Plant has been affected by poor quality process water which has recently deteriorated due to the higher proportion of zinc ore being treated as the ZEP ramp up continues. As such, SOMINCOR plans to increase the capacity of the Water Treatment Plant to improve metallurgical performance.

## **25.4 Infrastructure**

All infrastructure required by the operation is in place and no significant additional infrastructure is planned. In 2022, the footprint of the Cerro do Lobo TSF started to be expanded to the south to accommodate the ZEP. The TSF storage capacity was expanded from 33.3Mm<sup>3</sup> to 50Mm<sup>3</sup> for extractive waste storage (tailings and waste rock). The expansion will involve a 18.5Ha footprint extension to the south and a vertical expansion from 266.3m in Tier 5 to 283.5m in Tier 13. The TSF design has fill approvals to accommodate the current approved LOM.

## **25.5 Environmental Studies, Permitting and Social or Community Impact**

From review of the documentation provided, the environmental and social aspects of the Neves-Corvo Mine are considered in compliance with Portuguese legislation and international best practice.

The authors consider the environmental and social aspects of the Neves-Corvo Mine are well understood and managed. Effective communication and engagement with local Stakeholders has been successful in ensuring a mutually beneficial operation.

The EIA studies, management plans and reports, demonstrate LMC's commitment to the reduction of environmental and social risks. However, the recent incident with the ZEP pipeline ruptures highlights the importance of effective quality control and integrity monitoring programmes.

## **25.6 Capital and Operating Costs**

Capital and operating costs are defined in the LOM schedule and are based on the production plan and operational experience. Total capital costs are estimated at €591.7M over the LOM. Closure costs are estimated at €52.0M based on the LOM cash flow model dated November 14, 2022. Total operating costs over the LOM are estimated at €2,762M which equates to €60.6/t of ore milled.

## **25.7 Economic Analysis**

The cash flow model for the LOM was reviewed by the authors and showed the Mineral Reserves to be economic based on the assumptions used and metal prices of: US\$1.15/lb for zinc, US\$0.90/lb for lead, US\$3.35/lb for copper and US\$4.40/oz for silver (the silver price used reflects the contract to Wheaton Precious Metals Corp.).

## **25.8 Risks and Uncertainties**

The Neves-Corvo Mine is a mature operation with a long production history. The authors consider there are no significant risks or uncertainties that could be expected to affect the reliability or confidence of the Mineral Resources, Mineral Reserves and projected production based on the assumptions used.



## 26 RECOMMENDATIONS

The authors make the following recommendations:

### 26.1 Geology and Mineral Resource Estimates

- Continue exploration drilling at Lombador North, Zambujal East and Semblana East and North. A total of US\$7.36M is budgeted for exploration drilling in 2023;
- Recommence density measurements for underground drilling;
- Optimise underground development to provide increased drill access for pre-production drilling;
- Consider using strings or wireframe boundaries to define Mineral Resource classification in the block model;
- Consider the use of a NSR cut-off value for reporting Mineral Resources.

### 26.2 Mining Methods & Mineral Reserve Estimate

Complete all remaining optimisation projects for ZEP to achieve its name plate capacity. The costs for this work have been included in the capital cost estimate with €12.2M in 2023 and €9.6M in 2024.

### 26.3 Mineral Processing

- Prepare an up-to-date Process Design Criteria for the ZEP;
- Upgrade the Water Treatment Plant to 1,200m<sup>3</sup>/h at an estimated cost of €8.1M;
- Undertake lead rougher flotation at pH 9 and zinc rougher flotation at pH 10-11, using the improved water quality;
- Switch the method of lead rougher concentrate regrinding from conventional ball milling to either Isamill or SMD. This work is underway, with eventual completion within the Full-Lead project scope.

### 26.4 Environmental Studies, Permitting and Social or Community Impact

- Continue proactive management of pipeline integrity from risk identification to mitigation;
- Continue to monitor and review noise levels from evaporators. Investigate further noise abatement measures and closely monitor any grievances related to noise levels;
- Timely update and submission to the authorities of required operational management plans;
- Monitor and review any incidents of non-conformance, including H&S incidents. Determine any causation and implement risk management measures including continuing to advance the implementation of the Fatal Risk Management program;
- Include an evaluation of H&S performance after suppliers and contractors have completed their work, including H&S monitoring as part of the quality control process of contract closure;

- Make sure to communicate the results of the H&S Committee on a bi-weekly, or at least monthly basis with all SOMINCOR employees, suppliers and contractors. Consider inviting contractors and suppliers as observers during the H&S Committee meetings so they are immediately aware of H&S priorities;
- Implement the proposed gender diversity strategy to encourage female workers to work at Neves-Corvo, plan regional events and scholarships encouraging girls and young women from the region to consider studying mining industry-related subjects.

Costs of the works relating to the environmental, permitting and social or community impact recommendations are included as part of on-going operations.

## 27 REFERENCES

- Acusti Control, 2021. Cerro Do Lobo Dam Evaporators Acoustic Evaluation;
- Agência Portuguesa Do Ambiente, 2017. Decisão sobre a Conformidade Ambiental do Projeto de Execução (environmental conformity declaration (DCAPE));
- Agência Portuguesa Do Ambiente, 2017. Declaração de Impacte Ambiental (environmental impact declaration (DIA));
- Agência Portuguesa Do Ambiente, 2021. Licença de Utilização dos Recursos Hídricos – Captação de Água Superficial (water abstraction license);
- Direção Geral de Energia e Geologia, 2015. Plano de Racionalização do Consumo de Energia 2015-2022 (Energy Consumption Optimisation Plan (2015-2022));
- Get2C, 2019. Inventário De Emissões De Gee Da Somincor, S.A. (GHG Inventory Report);
- Gibson, HL., Allen, RL., Riverin, G., and Lane, TE., 2007. The VMS Model: Advances and Application to Exploration Targeting. Proceedings of Exploration 07: Fifth Decennial International Conference on Mineral Exploration, pp 713-730;
- Hannington, MD., Jonasson, IR., Herzig, PM., and Petersen, S., 1995. Physical and chemical processes of seafloor mineralisation at mid-ocean ridges: Seafloor Hydrothermal Systems: Physical, Chemical, Biological and Geological Interactions, v. AGU Geophysical Monograph 91, pp. 115-157;
- Instituto de Conservação da Natureza e das Florestas, 2019-2020. Authorisation to Cut Holm Oaks and Authorisation for Compensatory Replantation;
- Itasca Consultants, 2013. Preliminary Rock Mass Assessment for Lombador East Phase 2 and Lombador North Phase 2;
- Leistel, JM., Marcoux, E., Thiéblemont, D., Quesada, C., Sánchez, A., Almodóvar, GR., Pascual, E., and Sáez, R., 1998. The volcanic-hosted massive sulphide deposits of the Iberian Pyrite Belt. Mineralium Deposita, 33: 2-30;
- Lundin Mining, 2021. Donativos e apoios concedidos em 2021 (Donations and community support report in 2021);
- Lundin Mining, 2021. Resumo dos resultados do SLO survey, Summary of Social License to Operate (SLO) Survey Results;
- Lundin Mining, 2019. Sustainability Report;
- Lundin Mining, 2020. Sustainability Report;
- Lundin Mining, 2021. Sustainability Report;
- Lundin mining, 2022. Total lesões no ano 23, Total injuries report;

Lydon, JW., 1984. Volcanogenic massive sulphide deposits, Part 1 – A descriptive model: Geoscience Canada, v11, p. 195-202  
The volcanic-hosted massive sulphide deposits of the Iberian Pyrite Belt. Mineralium Deposita, 33: 2-30;

Maia, R., SOMINCOR, 2019, Gestao de Crise e Emergencia, Crisis and Emergency Management;

Mining One Consultants, 2019. Updated 3D Numerical Modelling of Major Excavations for Materials Handling System, Zinc Expansion Project;

Mining One Consultants, 2021. Geotechnical Analysis of the Lombador Phase 2 Expansion Project and Decline Positioning, pp 11;

Mining One Consultants, 2022. 3018\_G Lombador Geotechnical Assessment LP2 2022 Design Modelling Results Report;

Moreira, E., SOMINCOR, 2021. Protocolo de Ativacao da Emergencia, Emergency Activation Protocol;

Oliveira, JT., Rosa, CJP., Pereira, Z., Rosa, DRN., Matos, JX., Inverno, CMC., and Andersen, T., 2013. Geology of the Rosário-Neves antiform, Iberian Pyrite Belt, Portugal: New insights from physical volcanology, palynostratigraphy and isotope geochronology studies. Mineralium Deposita, DOI 10.1007/s00126-012-0453-0;

Pernas, G., SOMINCOR, 2020. Communications Plan, Neves-Corvo Operations;

Pernas, G., SOMINCOR, 2020. Grievance Management Plan, Neves-Corvo Operations;

Pernas, G., SOMINCOR, 2020. Stakeholder Engagement Plan Neves-Corvo Operations;

Relvas, JMRS., Barriga, FJAS., Longstaffe, F., 2006. Hydrothermal alteration and mineralisation in the Neves-Corvo volcanic-hosted massive sulfide deposit, Portugal. I. Geology, mineralogy, and geochemistry. Econ Geol 101:753–790;

SOMINCOR, 2019. Action Plan 2019 (Rev B);

SOMINCOR, 2018. BREF – Gestão de Resíduos da Indústria Extrativa (List of introduced BATs in the area of extractive industry waste management);

SOMINCOR, Discharges and emissions monitoring results for 2019 and 2021;

SOMINCOR, 2019. Comunicação De Incidente (Information on Environmental Incidents for 2019);

SOMINCOR, 2021. Comunicação De Incidente (Information on Environmental Incidents for 2021);

SOMINCOR, 2022. Comunicação De Incidente (Information on Environmental Incidents for 2022);

SOMINCOR, 2022. Plano de Encerramento e Plano Ambiental e de Recuperação Paisagística (PARP) Mina de Neves-Corvo (Mine Closure Plan);

SOMINCOR, 2021. Plano de Seguranca e de Saude, Health and Safety Plan;

SOMINCOR, 2022. Relatório de Monitorização Pós-Avaliação (Annual Environmental Report (RAA) 2021);

SOMINCOR, 2022. Somincor\_LOM\_model\_2023\_20221114\_TC. Life of mine cash flow model prepared by SOMINCOR and dated November 14, 2022;

SRK Consulting, 2015. Neves-Corvo Mine – Lombador Phase 2 Geotechnical Study;

WAI, 2013. NI 43-101 Technical Report for Neves-Corvo Mine and Semblana Deposit, Portugal. Technical Report prepared by WAI for Lundin Mining Corporation and dated January 18, 2013;

WAI, 2017. NI 43-101 Technical Report for Neves-Corvo Mine, Portugal. Technical Report prepared by WAI for Lundin Mining Corporation and dated June 23, 2017.

### CERTIFICATE OF QUALIFIED PERSON

I, Richard John Ellis, BSc, MSc, MCSM, FGS, CGeol, EurGeol, as an author of this report titled “NI 43-101 Technical Report on the Neves-Corvo Mine, Portugal” dated February 22, 2023, and with an effective date of December 31, 2022, do hereby certify that:

- I am a Principal Resource Geologist with Wardell Armstrong International, with a business address at Baldhu House, Wheal Jane Earth Science Park, Baldhu, Truro, Cornwall, United Kingdom, TR3 6EH.
- I am a graduate of the University of Bristol in the United Kingdom (BSc (Hons) Geology, 2001) and Camborne School of Mines (University of Exeter) in the United Kingdom (MSc Mining Geology, 2003). I have practiced my profession continuously since 2003 and have estimated and audited Mineral Resources for a variety of commodities, including base metals related to volcanogenic massive sulphide deposits.
- I have read the definition of “Qualified Person” set out in NI 43-101 and certify that by reason of my education, affiliation with a professional association and past relevant work experience, I fulfil the requirements of a “Qualified Person” for the purposes of NI 43-101.
- I am a registered member in good standing of the Geological Society of London as a Fellow and Chartered Geologist (# 1013201) and a registered European Geologist as elected by the European Federation of Geologists.
- I last personally inspected the Neves-Corvo Mine on November 2 to November 3, 2022.
- I am the co-author of this report and responsible for Sections: 1 (Introduction), 1.1, 1.2, 1.3, 1.4, 1.5, 1.6, 1.8, 1.17 (Introduction), 1.17.1, 2, 3, 4, 5, 6, 7, 8, 9, 10, 11, 12, 14, 23, 24, 25 (Introduction), 25.1, 25.8 (Mineral Resources), 26 (Introduction), 26.1 and 27.
- I am independent of the issuer, Lundin Mining Corporation, as defined by Section 1.5 of NI 43-101.
- I have had prior involvement with the Neves-Corvo Mine that is the subject of the Technical Report, including a Technical Report for Lundin Mining Corporation dated June 23, 2017, and a Technical Report for Lundin Mining Corporation dated January 18, 2013.
- I have read NI 43-101, and the Technical Report has been prepared in compliance with NI 43-101 and Form 43-101F1.
- At the effective date of the Technical Report, to the best of my knowledge, information and belief, the sections of the Technical Report that I am responsible for contain all scientific and technical information that is required to be disclosed to make the Technical Report not misleading.

Dated this 22<sup>nd</sup> day of February, 2023.

**(Signed & Sealed) Richard J. Ellis**

Richard Ellis BSc, MSc, MCSM, FGS, CGeol, EurGeol

### CERTIFICATE OF QUALIFIED PERSON

I, Stuart Andrew Richardson, BEng, MSc, CEng, MIMMM, as an author of this report titled “NI 43-101 Technical Report on the Neves-Corvo Mine, Portugal” dated February 22, 2023, and with an effective date of December 31, 2022, do hereby certify that:

- I am an Associate Director with Wardell Armstrong International, with a business address at Baldhu House, Wheal Jane Earth Science Park, Baldhu, Truro, Cornwall, United Kingdom, TR3 6EH.
- I am a graduate of the University of Exeter in the United Kingdom (BEng Mining Geology, 2006; MSc Mining Engineering 2016). I have practiced my profession continuously since 2007 and have estimated and audited Mineral Reserves for a variety of commodities, including base metals related to volcanogenic massive sulphide deposits.
- I have read the definition of “Qualified Person” set out in NI 43-101 and certify that by reason of my education, affiliation with a professional association and past relevant work experience, I fulfil the requirements of a “Qualified Person” for the purposes of NI 43-101.
- I am a registered member in good standing of the Institute of Mining, Metallurgy and Materials and Chartered Engineer (#496923).
- I last personally inspected the Neves-Corvo Mine on November 2 to November 3, 2022.
- I am the co-author of this report and responsible for Sections: 1.9, 1.10, 1.15 (Mining Capital and Operating Costs), 1.16, 1.17.2, 15, 16, 21.1 (Mining Capital Costs), 21.2 (Mining Operating Costs), 22, 25.2, 25.6 (Mining Capital and Operating Costs), 25.7, 25.8 (Mineral Reserves and Projected Production) and 26.2.
- I am independent of the issuer, Lundin Mining Corporation, as defined by Section 1.5 of NI 43-101.
- I have had prior involvement with the Neves-Corvo Mine that is the subject of the Technical Report, including a Technical Report for Lundin Mining Corporation dated January 18, 2013.
- I have read NI 43-101, and the Technical Report has been prepared in compliance with NI 43-101 and Form 43-101F1.
- At the effective date of the Technical Report, to the best of my knowledge, information and belief, the sections of the Technical Report that I am responsible for contain all scientific and technical information that is required to be disclosed to make the Technical Report not misleading.

Dated this 22<sup>nd</sup> day of February, 2023.

**(Signed & Sealed) Stuart A. Richardson**

Stuart Richardson BEng, MSc, CEng, MIMMM

### CERTIFICATE OF QUALIFIED PERSON

I, Philip Arthur King, BSc, ARSM, CEng, FIMMM, as an author of this report titled “NI 43-101 Technical Report on the Neves-Corvo Mine, Portugal” dated February 22, 2023, and with an effective date of December 31, 2022, do hereby certify that:

- I am a Technical Director with Wardell Armstrong International, with a business address at Baldhu House, Wheal Jane Earth Science Park, Baldhu, Truro, Cornwall, United Kingdom, TR3 6EH.
- I am a graduate of the Imperial College, London in the United Kingdom (BSc (Hons) Mineral Technology, 1980). I have practiced my profession continuously since 1980 in a variety of countries and commodities and have been involved with the minerals processing of volcanogenic massive sulphide deposits for more than 40 years.
- I have read the definition of “Qualified Person” set out in NI 43-101 and certify that by reason of my education, affiliation with a professional association and past relevant work experience, I fulfil the requirements of a “Qualified Person” for the purposes of NI 43-101.
- I am a registered member in good standing of the Institute of Mining, Metallurgy and Materials and Chartered Engineer (# 358035).
- I last personally inspected the Neves-Corvo Mine on November 2 to November 3, 2022.
- I am the co-author of this report and responsible for Sections: 1.7, 1.11, 1.12, 1.13, 1.15 (Processing Capital and Operating Costs), 1.17.3, 13, 17, 18, 19, 21.1 (Processing Capital Costs), 21.2 (Processing Operating Costs), 25.3, 25.4, 25.6 (Processing Capital and Operating Costs) and 26.3.
- I am independent of the issuer, Lundin Mining Corporation, as defined by Section 1.5 of NI 43-101.
- I have had prior involvement with the Neves-Corvo Mine that is the subject of the Technical Report, including a Technical Report for Lundin Mining Corporation dated June 23, 2017, and a Technical Report for Lundin Mining Corporation dated January 18, 2013.
- I have read NI 43-101, and the Technical Report has been prepared in compliance with NI 43-101 and Form 43-101F1.
- At the effective date of the Technical Report, to the best of my knowledge, information and belief, the sections of the Technical Report that I am responsible for contain all scientific and technical information that is required to be disclosed to make the Technical Report not misleading.

Dated this 22<sup>nd</sup> day of February, 2023.

**(Signed & Sealed) Philip A. King**

Philip King BSc, ARSM, CEng, FIMMM



### CERTIFICATE OF QUALIFIED PERSON

I, Alison Brianna Allen, BSc, MSc, CEnv, FIMMM, MIEMA, MIEEM, as an author of this report titled “NI 43-101 Technical Report on the Neves-Corvo Mine, Portugal” dated February 22, 2023, and with an effective date of December 31, 2022, do hereby certify that:

- I am a Regional Director with Wardell Armstrong International, with a business address at Baldhu House, Wheal Jane Earth Science Park, Baldhu, Truro, Cornwall, United Kingdom, TR3 6EH.
- I am a graduate of the University of East Anglia in the United Kingdom (BSc (Hons) Natural Sciences, 2001) and Camborne School of Mines (University of Exeter) in the United Kingdom (MSc Mining Environmental Management, 2008). I have practiced my profession continuously since 2001 in a variety of countries and commodities, and including preparing Environmental and Social Chapters and Impact assessments for gold and base metals;
- I have read the definition of “Qualified Person” set out in NI 43-101 and certify that by reason of my education, affiliation with a professional association and past relevant work experience, I fulfil the requirements of a “Qualified Person” for the purposes of NI 43-101.
- I am a Fellow of the Institute of Mining, Metallurgy and Materials (# 474370), and a Chartered Environmentalist of the Institute of Environmental Management and Assessment (# 0013685).
- I did not visit the Neves-Corvo Mine.
- I am the co-author of this report and responsible for Sections: 1.14, 1.15 (Closure Costs), 1.17.4, 20, 21.1 (Closure Costs), 25.5, 25.6 (Closure Costs) and 26.4
- I am independent of the issuer, Lundin Mining Corporation, as defined by Section 1.5 of NI 43-101.
- I have not had prior involvement with the Neves-Corvo Mine that is the subject of the Technical Report.
- I have read NI 43-101, and the Technical Report has been prepared in compliance with NI 43-101 and Form 43-101F1.
- At the effective date of the Technical Report, to the best of my knowledge, information and belief, the sections of the Technical Report that I am responsible for contain all scientific and technical information that is required to be disclosed to make the Technical Report not misleading.

Dated this 22<sup>nd</sup> day of February, 2023.

**(Signed & Sealed) Alison B. Allen**

Alison Allen BSc, MSc, CEnv, FIMMM, MIEMA, MIEEM

**STOKE-ON-TRENT**

Sir Henry Doulton House  
Forge Lane  
Etruria  
Stoke-on-Trent  
ST1 5BD  
Tel: +44 (0)1782 276 700

**BIRMINGHAM**

Two Devon Way  
Longbridge Technology Park  
Longbridge  
Birmingham  
B31 2TS  
Tel: +44 (0)121 580 0909

**BOLTON**

41-50 Futura Park  
Aspinall Way  
Middlebrook  
Bolton  
BL6 6SU  
Tel: +44 (0)1204 227 227

**BRISTOL**

Desk Lodge  
2 Redcliffe Way  
Bristol  
BS1 6NL  
Tel: +44 (0)117 203 4477

**BURY ST EDMUNDS**

Armstrong House  
Lamdin Road  
Bury St Edmunds  
Suffolk  
IP32 6NU  
Tel: +44 (0)1284 765 210

**CARDIFF**

Tudor House  
16 Cathedral Road  
Cardiff  
CF11 9LJ  
Tel: +44 (0)292 072 9191

**CARLISLE**

Marconi Road  
Burgh Road Industrial Estate  
Carlisle  
Cumbria  
CA2 7NA  
Tel: +44 (0)1228 550 575

**EDINBURGH**

Great Michael House  
14 Links Place  
Edinburgh  
EH6 7EZ  
Tel: +44 (0)131 555 3311

**GLASGOW**

24 St Vincent Place  
Glasgow  
G1 2EU  
Tel: +44 (0)141 428 4499

**LEEDS**

36 Park Row  
Leeds  
LS1 5JL  
Tel: +44 (0)113 831 5533

**LONDON**

Third Floor  
46 Chancery Lane  
London  
WC2A 1JE  
Tel: +44 (0)207 242 3243

**NEWCASTLE UPON TYNE**

City Quadrant  
11 Waterloo Square  
Newcastle upon Tyne  
NE1 4DP  
Tel: +44 (0)191 232 0943

**TRURO**

Baldhu House  
Wheal Jane Earth Science Park  
Baldhu  
Truro  
TR3 6EH  
Tel: +44 (0)187 256 0738

**International office:**

**ALMATY**

29/6 Satpaev Avenue  
Hyatt Regency Hotel  
Office Tower  
Almaty  
Kazakhstan  
050040  
Tel: +7(727) 334 1310